

Tompkins[®]

INDUSTRIES, INC.



MASTER CATALOG

RD 269 REV 5 1.22.14

TOMPKINS INDUSTRIES INC

CATALOG

More Than Four Decades in Business

Though the history of Tompkins Industries spans more than four decades, the same values on which the company was built remain relevant today. Company founder, J.L. Tompkins Sr., sought to create a business which provided reliable products at competitive prices. A company that made customer service a primary goal.

Benefits to our Customers

From a meager beginning in J.L. Tompkins' garage in 1967, Tompkins Industries has grown to be a major supplier of hydraulic adapters and related products. As an ISO Certified Company, you can trust Tompkins products to meet or exceed industry standards. Customer benefits remain at the core of any decision as Tompkins continues to grow and plan for the future. In 2011, following a merger with Can-Am Hydraulic Products, Ltd., Tompkins expanded into Canada, doing business as Tompkins Canada. Add that to competitive pricing and one of the largest in-stock inventories in the industry and you've got what Tompkins Industries, Inc. is all about: customer satisfaction, order after order.

Tompkins Industries Mission

Our mission is to supply quality products to our customers with the highest level of service. We will always look for ways to improve our product line. We will continue to be the leader in offering new products, services and innovations. The market will drive us as we stay close to our customers and listen to them. They are the reason we exist.

TABLE OF CONTENTS

Hydraulic Adapters & Fittings	3	Quick Disconnects	259
37° JIC Adapters	4	ANV	260
SAE O-Ring Adapters	42	NV	262
Pipe Adapters	48	HNV	264
Pipe Swivel Adapters	66	PVVM	266
O-Ring Face Seal Adapters	74	TNV	267
Beaded Hose Fittings	91	FFI	268
		FB	271
Flanges & Flange Adapters	95	PD	273
JIC Flange Adapters	96	ST	275
O-Ring Face Seal Flange	99		
No Braze Flange Adapters	101	Test Points & Test Kits	277
Code 61 Flange Components	105	Test Points	278
Code 62 Flange Components	109	Test Point Kits	285
Metric Adapters & Fittings	113	Aerosols	289
BSPP Adapters	114		
BSPT Adapters	140	Clamps	293
Metric Adapters	145		
30° Seat Adapters	152	Hydraulic Tank Components	297
Metric Compression Fittings	156	Hydraulic Tank Covers - Cleanout Covers	298
Thread Identification Kits	178	Tank Weld Flanges	299
Live Swivels	179	Appendix:	
		Technical Information	301
Brass Adapters & Fittings	189	About Working Pressure	302
Brass Pipe Adapters	190	Methods for Installing Fittings	302
Brass SAE 45° Adapters	198	JIC Adapter Specifications	305
Brass Hose Barb Fittings	205	Pipe & Pipe Swivel Adapter Specifications	307
Brass Push-On Barb Fittings	210	O-ring Face Seal Adapter Specifications	308
Brass Compression Adapters	214	BSPT, BSPP (DIN 3852-2)	
Brass Inverted Flare Adapters	220	and Metric (DIN 3852-1) Adapter Specifications	312
Brass Needle Valves and Drain Cocks	224	Metric Compression Tube	
Brass Poly Flow Fittings	227	(DIN LL, L, & S) Adapter Specifications	315
Brass Poly Push Fittings	231	Metric ISO 6149 Adapter Specifications	316
Brass D.O.T. Air Brake Fittings	235	Compression & Flared Adapter	
Brass Push-In D.O.T. Fittings	240	Thread Sizes	317
Brass Garden Hose Fittings	244	JIS & Komatsu® Adapter	
		Thread Sizes	317
Ball Valves	247	Quick Disconnect Identification Chart	318
Hose Protection	251	Index	321



HYDRAULIC ADAPTERS & FITTINGS

37° JIC Adapters

2403



JIC Union

SHAPE

Straight

AVAILABILITY

- » Import Steel
- » Steel
- » Import Stainless Steel
- » Stainless Steel

COMPLIANCE

- » MS 51501
- » SAE 070101

Dash Size	Male JIC	Male JIC
02-02	5/16-24	5/16-24
03-02	3/8-24	5/16-24
03-03	3/8-24	3/8-24
04-02	7/16-20	5/16-24
04-03	7/16-20	3/8-24
04-04	7/16-20	7/16-20
05-04	1/2-20	7/16-20
05-05	1/2-20	1/2-20
06-04	9/16-18	7/16-20
06-05	9/16-18	1/2-20
06-06	9/16-18	9/16-18
08-04	3/4-16	7/16-20
08-05	3/4-16	1/2-20
08-06	3/4-16	9/16-18
08-08	3/4-16	3/4-16
10-04	7/8-14	7/16-20
10-05	7/8-14	1/2-20
10-06	7/8-14	9/16-18
10-08	7/8-14	3/4-16
10-10	7/8-14	7/8-14
12-04	1 1/16-12	7/16-20
12-06	1 1/16-12	9/16-18
12-08	1 1/16-12	3/4-16
12-10	1 1/16-12	7/8-14
12-12	1 1/16-12	1 1/16-12
14-12	1 3/16-12	1 1/16-12
14-14	1 3/16-12	1 3/16-12
16-06	1 5/16-12	9/16-18
16-08	1 5/16-12	3/4-16
16-10	1 5/16-12	7/8-14
16-12	1 5/16-12	1 1/16-12
16-14	1 5/16-12	1 3/16-12
16-16	1 5/16-12	1 5/16-12
20-12	1 5/8-12	1 1/16-12
20-16	1 5/8-12	1 5/16-12
20-20	1 5/8-12	1 5/8-12
24-12	1 7/8-12	1 1/16-12
24-16	1 7/8-12	1 5/16-12
24-20	1 7/8-12	1 5/8-12
24-24	1 7/8-12	1 7/8-12
32-16	2 1/2-12	1 5/16-12
32-24	2 1/2-12	1 7/8-12
32-32	2 1/2-12	2 1/2-12

JIC Large Hex Union

SHAPE

Straight

Dash Size	Male JIC	Male JIC
02-02	5/16-24	5/16-24
03-03	3/8-24	3/8-24
04-02	7/16-20	5/16-24
04-03	7/16-20	3/8-24
04-04	7/16-20	7/16-20
05-05	1/2-20	1/2-20
06-04	9/16-18	7/16-20
06-05	9/16-18	1/2-20
06-06	9/16-18	9/16-18
08-04	3/4-16	7/16-20
08-06	3/4-16	9/16-18
08-08	3/4-16	3/4-16
10-10	7/8-14	7/8-14
12-08	1 1/16-12	3/4-16
12-10	1 1/16-12	7/8-14
12-12	1 1/16-12	1 1/16-12
16-08	1 5/16-12	3/4-16
16-12	1 5/16-12	1 1/16-12
16-16	1 5/16-12	1 5/16-12
20-20	1 5/8-12	1 5/8-12
24-24	1 7/8-12	1 7/8-12

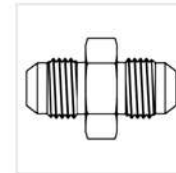

2403-LH

COMPLIANCE

- » MS 51519
- » SAE 070119

AVAILABILITY

- » Steel
- » Stainless Steel

JIC to Pipe

RST - Available in restricted orifice, contact a Customer Service Representative at (800) 255-1008 for availability.

SHAPE

Straight

Dash Size	Male JIC	Male Pipe
02-02	5/16-24	1/8-27
02-04	5/16-24	1/4-18
03-02	3/8-24	1/8-27
03-04	3/8-24	1/4-18
04-02	7/16-20	1/8-27
04-04	7/16-20	1/4-18
04-06	7/16-20	3/8-18
04-08	7/16-20	1/2-14
04-12	7/16-20	3/4-14
05-02	1/2-20	1/8-27
05-04	1/2-20	1/4-18
05-06	1/2-20	3/8-18
05-08	1/2-20	1/2-14
06-02	9/16-18	1/8-27
06-04	9/16-18	1/4-18
06-06	9/16-18	3/8-18
06-08	9/16-18	1/2-14
06-12	9/16-18	3/4-14
06-16	9/16-18	1-11 1/2
08-02	3/4-16	1/8-27
08-04	3/4-16	1/4-18
08-06	3/4-16	3/8-18
08-08	3/4-16	1/2-14

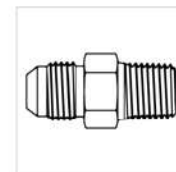

2404

COMPLIANCE

- » MS 51500
- » SAE 070102

AVAILABILITY

- » Import Steel
- » Steel
- » Import Stainless Steel
- » Stainless Steel

▼ 2404 continues

2404
 ▼ continued

Dash Size	Male JIC	Male Pipe
08-12	3/4-16	3/4-14
08-16	3/4-16	1-11 1/2
10-04	7/8-14	1/4-18
10-06	7/8-14	3/8-18
10-08	7/8-14	1/2-14
10-12	7/8-14	3/4-14
10-16	7/8-14	1-11 1/2
12-04	1 1/16-12	1/4-18
12-06	1 1/16-12	3/8-18
12-08	1 1/16-12	1/2-14
12-12	1 1/16-12	3/4-14
12-16	1 1/16-12	1-11 1/2
12-20	1 1/16-12	1 1/4-11 1/2
12-24	1 1/16-12	1 1/2-11 1/2
14-08	1 3/16-12	1/2-14
14-12	1 3/16-12	3/4-14
14-16	1 3/16-12	1-11 1/2
16-08	1 5/16-12	1/2-14
16-12	1 5/16-12	3/4-14
16-16	1 5/16-12	1-11 1/2
16-20	1 5/16-12	1 1/4-11 1/2
16-24	1 5/16-12	1 1/2-11 1/2
16-32	1 5/16-12	2-11 1/2
20-12	1 5/8-12	3/4-14
20-16	1 5/8-12	1-11 1/2
20-20	1 5/8-12	1 1/4-11 1/2
20-24	1 5/8-12	1 1/2-11 1/2
20-32	1 5/8-12	2-11 1/2
24-12	1 7/8-12	3/4-14
24-16	1 7/8-12	1-11 1/2
24-20	1 7/8-12	1 1/4-11 1/2
24-24	1 7/8-12	1 1/2-11 1/2
24-32	1 7/8-12	2-11 1/2
32-12	2 1/2-12	3/4-14
32-16	2 1/2-12	1-11 1/2
32-20	2 1/2-12	1 1/4-11 1/2
32-24	2 1/2-12	1 1/2-11 1/2
32-32	2 1/2-12	2-11 1/2
32-40	2 1/2-12	2 1/2-8
40-40	3-12	2 1/2-8
48-48	3 1/2-12	3-8

2404-L

JIC to Pipe - Long
SHAPE

Straight

Dash Size	Male JIC	Male Pipe	Overall Adapter Length (OAL)
02-04	5/16-24	1/4-18	1.81
04-02	7/16-20	1/8-27	1.81
04-04	7/16-20	1/4-18	2.25
05-02	1/2-20	1/8-27	2.25
05-04	1/2-20	1/4-18	2.25
06-04	9/16-18	1/4-18	2.25
06-06	9/16-18	3/8-18	2.50

AVAILABILITY

- » Import Steel
- » Steel
- » Import Stainless Steel
- » Stainless Steel

Dash Size	Male JIC	Male Pipe	Overall Adapter Length (OAL)
06-06	9/16-18	3/8-18	2.75
08-06	3/4-16	3/8-18	2.75
08-08	3/4-16	1/2-14	3.04
10-08	7/8-14	1/2-14	3.12
12-12	1 1/16-12	3/4-14	3.50
16-16	1 5/16-12	1-11 1/2	4.00
20-20	1 5/8-12	1 1/4-11 1/2	4.50
24-24	1 7/8-12	1 1/2-11 1/2	5.00

2404-L
▼ continued

JIC to Pipe - Extra Long

SHAPE

Straight

Dash Size	Male JIC	Male Pipe	Overall Adapter Length (OAL)
04-02	7/16-20	1/8-27	2.56
04-04	7/16-20	1/4-18	3.25
06-04	9/16-18	1/4-18	3.25
06-06	9/16-18	3/8-18	4.00
08-06	3/4-16	3/8-18	4.00
08-08	3/4-16	1/2-14	4.20
10-08	7/8-14	1/2-14	4.375
12-12	1 1/16-12	3/4-14	5.00
16-12	1 5/16-12	3/4-14	5.50
16-16	1 5/16-12	1-11 1/2	5.75

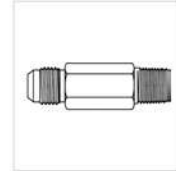

2404-LL

COMPLIANCE
» MS 51503

AVAILABILITY
» Import Steel
» Steel

JIC to Pipe - Extra Extra Long

SHAPE

Straight

Dash Size	Male JIC	Male Pipe	Overall Adapter Length (OAL)
04-02	7/16-20	1/8-27	3.50
08-08	3/4-16	1/2-14	5.50
10-08	7/8-14	1/2-14	5.50

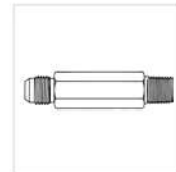

2404-LLL

AVAILABILITY
» Steel

JIC to Pipe

SHAPE

Straight

Dash Size	Male JIC	Female Pipe
02-02	5/16-24	1/8-27
02-04	5/16-24	1/4-18
03-02	3/8-24	1/8-27
03-04	3/8-24	1/4-18
04-02	7/16-20	1/8-27
04-04	7/16-20	1/4-18
04-06	7/16-20	3/8-18
04-08	7/16-20	1/2-14
05-02	1/2-20	1/8-27
05-04	1/2-20	1/4-18
05-06	1/2-20	3/8-18
06-02	9/16-18	1/8-27
06-04	9/16-18	1/4-18
06-06	9/16-18	3/8-18

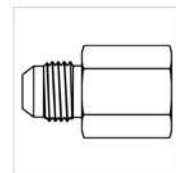

2405

COMPLIANCE
» SAE 070103

AVAILABILITY
» Import Steel
» Steel
» Import Stainless Steel
» Stainless Steel

▼ 2405 continues

2405
 ▼ continued

Dash Size	Male JIC	Female Pipe
06-08	9/16-18	1/2-14
06-12	9/16-18	3/4-14
08-02	3/4-16	1/8-27
08-04	3/4-16	1/4-18
08-06	3/4-16	3/8-18
08-08	3/4-16	1/2-14
08-12	3/4-16	3/4-14
08-16	3/4-16	1-11 1/2
10-06	7/8-14	3/8-18
10-08	7/8-14	1/2-14
10-12	7/8-14	3/4-14
10-16	7/8-14	1-11 1/2
12-08	1 1/16-12	1/2-14
12-12	1 1/16-12	3/4-14
12-16	1 1/16-12	1-11 1/2
14-12	1 3/16-12	3/4-14
14-16	1 3/16-12	1-11 1/2
16-12	1 5/16-12	3/4-14
16-16	1 5/16-12	1-11 1/2
16-20	1 5/16-12	1 1/4-11 1/2
16-24	1 5/16-12	1 1/2-11 1/2
20-16	1 5/8-12	1-11 1/2
20-20	1 5/8-12	1 1/4-11 1/2
20-24	1 5/8-12	1 1/2-11 1/2
20-32	1 5/8-12	2-11 1/2
24-16	1 7/8-12	1-11 1/2
24-20	1 7/8-12	1 1/4-11 1/2
24-24	1 7/8-12	1 1/2-11 1/2
24-32	1 7/8-12	2-11 1/2
32-24	2 1/2-12	1 1/2-11 1/2
32-32	2 1/2-12	2-11 1/2

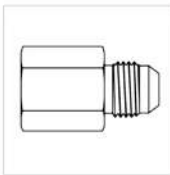
2406

JIC Reducer/Expander

RST - Available in restricted orifice, contact a Customer Service Representative at (800) 255-1008 for availability.

SHAPE

Straight

AVAILABILITY

- » Import Steel
- » Steel
- » Import Stainless Steel
- » Stainless Steel

COMPLIANCE

- » MS 51534
- » SAE 070123

Dash Size	Female JIC	Male JIC
03-04	3/8-24	7/16-20
04-02	7/16-20	5/16-24
04-03	7/16-20	3/8-24
04-04	7/16-20	7/16-20
04-05	7/16-20	1/2-20
04-06	7/16-20	9/16-18
04-08	7/16-20	3/4-16
05-04	1/2-20	7/16-20
05-06	1/2-20	9/16-18
05-08	1/2-20	3/4-16
06-04	9/16-18	7/16-20
06-05	9/16-18	1/2-20
06-06	9/16-18	9/16-18
06-08	9/16-18	3/4-16
08-03	3/4-16	3/8-24
08-04	3/4-16	7/16-20

Dash Size	Female JIC	Male JIC
08-05	3/4-16	1/2-20
08-06	3/4-16	9/16-18
08-08	3/4-16	3/4-16
08-10	3/4-16	7/8-14
08-12	3/4-16	1 1/16-12
10-04	7/8-14	7/16-20
10-06	7/8-14	9/16-18
10-08	7/8-14	3/4-16
10-12	7/8-14	1 1/16-12
10-16	7/8-14	1 5/16-12
12-04	1 1/16-12	7/16-20
12-06	1 1/16-12	9/16-18
12-08	1 1/16-12	3/4-16
12-10	1 1/16-12	7/8-14
12-12	1 1/16-12	1 1/16-12
12-16	1 1/16-12	1 5/16-12
12-20	1 1/16-12	1 5/8-12
14-06	1 3/16-12	9/16-18
14-08	1 3/16-12	3/4-16
14-10	1 3/16-12	7/8-14
14-12	1 3/16-12	1 1/16-12
16-04	1 5/16-12	7/16-20
16-06	1 5/16-12	9/16-18
16-08	1 5/16-12	3/4-16
16-10	1 5/16-12	7/8-14
16-12	1 5/16-12	1 1/16-12
16-14	1 5/16-12	1 3/16-12
16-20	1 5/16-12	1 5/8-12
16-24	1 5/16-12	1 7/8-12
20-06	1 5/8-12	9/16-18
20-08	1 5/8-12	3/4-16
20-10	1 5/8-12	7/8-14
20-12	1 5/8-12	1 1/16-12
20-16	1 5/8-12	1 5/16-12
20-24	1 5/8-12	1 7/8-12
24-08	1 7/8-12	3/4-16
24-12	1 7/8-12	1 1/16-12
24-16	1 7/8-12	1 5/16-12
24-20	1 7/8-12	1 5/8-12
24-32	1 7/8-12	2 1/2-12
32-16	2 1/2-12	1 5/16-12
32-20	2 1/2-12	1 5/8-12
32-24	2 1/2-12	1 7/8-12

2406

▼ continued

2407

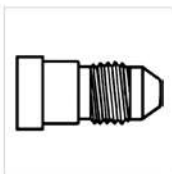

JIC Reducer

Requires item 318 JIC Tube Nut for assembly.

SHAPE

Straight

Dash Size	Female JIC	Male JIC
04-02	7/16-20	5/16-24
04-03	7/16-20	3/8-24
05-04	1/2-20	7/16-20
06-04	9/16-18	7/16-20
08-04	3/4-16	7/16-20
08-06	3/4-16	9/16-18
10-04	7/8-14	7/16-20
10-06	7/8-14	9/16-18
10-08	7/8-14	3/4-16
12-04	1 1/16-12	7/16-20
12-06	1 1/16-12	9/16-18
12-08	1 1/16-12	3/4-16
12-10	1 1/16-12	7/8-14
16-04	1 5/16-12	7/16-20
16-06	1 5/16-12	9/16-18
16-08	1 5/16-12	3/4-16
16-10	1 5/16-12	7/8-14
16-12	1 5/16-12	1 1/16-12
20-08	1 5/8-12	3/4-16
20-12	1 5/8-12	1 1/16-12
20-16	1 5/8-12	1 5/16-12
24-08	1 7/8-12	3/4-16
24-12	1 7/8-12	1 1/16-12
24-16	1 7/8-12	1 5/16-12
24-20	1 7/8-12	1 5/8-12
32-24	2 1/2-12	1 7/8-12

AVAILABILITY

- » Steel
- » Stainless Steel

2408

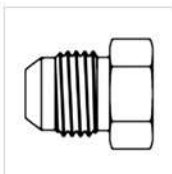

JIC Plug

SHAPE

Plug

Dash Size	Male JIC
02	5/16-24
03	3/8-24
04	7/16-20
05	1/2-20
06	9/16-18
08	3/4-16
10	7/8-14
12	1 1/16-12
14	1 3/16-12
16	1 5/16-12
20	1 5/8-12
24	1 7/8-12
32	2 1/2-12

AVAILABILITY

- Import Steel
- Steel
- Import Stainless Steel
- Stainless Steel

COMPLIANCE

- » MS 51518
- » SAE 070201

JIC Union Elbow 90°

SHAPE

90 degree elbow

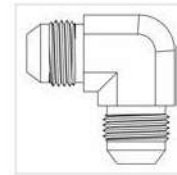

2500

Dash Size	Male JIC	Male JIC
02-02	5/16-24	5/16-24
03-03	3/8-24	3/8-24
04-04	7/16-20	7/16-20
05-04	1/2-20	7/16-20
05-05	1/2-20	1/2-20
06-04	9/16-18	7/16-20
06-05	9/16-18	1/2-20
06-06	9/16-18	9/16-18
08-04	3/4-16	7/16-20
08-06	3/4-16	9/16-18
08-08	3/4-16	3/4-16
10-08	7/8-14	3/4-16
10-10	7/8-14	7/8-14
12-08	1 1/16-12	3/4-16
12-10	1 1/16-12	7/8-14
12-12	1 1/16-12	1 1/16-12
14-14	1 3/16-12	1 3/16-12
16-12	1 5/16-12	1 1/16-12
16-16	1 5/16-12	1 5/16-12
20-16	1 5/8-12	1 5/16-12
20-20	1 5/8-12	1 5/8-12
24-24	1 7/8-12	1 7/8-12
32-32	2 1/2-12	2 1/2-12

COMPLIANCE

- » MS 51505
- » SAE 070201

AVAILABILITY

- » Import Steel
- » Steel
- » Import Stainless Steel
- » Stainless Steel

JIC to Pipe Elbow 90°

RST - Available in restricted orifice, contact a Customer Service Representative at (800) 255-1008 for availability.

SHAPE

90 degree elbow

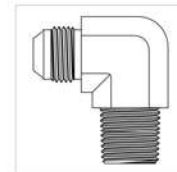

2501

Dash Size	Male JIC	Male Pipe
02-02	5/16-24	1/8-27
02-04	5/16-24	1/4-18
03-02	3/8-24	1/8-27
04-02	7/16-20	1/8-27
04-04	7/16-20	1/4-18
04-06	7/16-20	3/8-18
04-08	7/16-20	1/2-14
04-12	7/16-20	3/4-14
05-02	1/2-20	1/8-27
05-04	1/2-20	1/4-18
05-06	1/2-20	3/8-18
05-08	1/2-20	1/2-14
06-02	9/16-18	1/8-27
06-04	9/16-18	1/4-18
06-06	9/16-18	3/8-18
06-08	9/16-18	1/2-14
06-12	9/16-18	3/4-14
08-02	3/4-16	1/8-27
08-04	3/4-16	1/4-18
08-06	3/4-16	3/8-18
08-08	3/4-16	1/2-14

COMPLIANCE

- » MS 51504
- » SAE 070202

AVAILABILITY

- » Import Steel
- » Steel
- » Import Stainless Steel
- » Stainless Steel

▼ 2501 continues

2501
 ▼ continued

Dash Size	Male JIC	Male Pipe
08-12	3/4-16	3/4-14
08-16	3/4-16	1-11 1/2
10-04	7/8-14	1/4-18
10-06	7/8-14	3/8-18
10-08	7/8-14	1/2-14
10-12	7/8-14	3/4-14
10-16	7/8-14	1-11 1/2
12-06	1 1/16-12	3/8-18
12-08	1 1/16-12	1/2-14
12-12	1 1/16-12	3/4-14
12-16	1 1/16-12	1-11 1/2
12-20	1 1/16-12	1 1/4-11 1/2
14-12	1 3/16-12	3/4-14
14-16	1 3/16-12	1-11 1/2
16-08	1 5/16-12	1/2-14
16-12	1 5/16-12	3/4-14
16-16	1 5/16-12	1-11 1/2
16-20	1 5/16-12	1 1/4-11 1/2
16-24	1 5/16-12	1 1/2-11 1/2
20-12	1 5/8-12	3/4-14
20-16	1 5/8-12	1-11 1/2
20-20	1 5/8-12	1 1/4-11 1/2
20-24	1 5/8-12	1 1/2-11 1/2
24-16	1 7/8-12	1-11 1/2
24-20	1 7/8-12	1 1/4-11 1/2
24-24	1 7/8-12	1 1/2-11 1/2
24-32	1 7/8-12	2-11 1/2
32-24	2 1/2-12	1 1/2-11 1/2
32-32	2 1/2-12	2-11 1/2
40-40	3-12	2 1/2-8

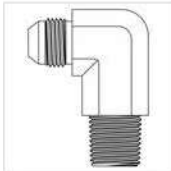
2501-L

JIC to Pipe - Long Elbow 90°

Drop Length = Middle of JIC to End of Male Pipe Threads.

SHAPE

90 degree elbow

AVAILABILITY

- » Import Steel
- » Steel
- » Import Stainless Steel
- » Stainless Steel

COMPLIANCE

- » SAE 071502

Dash Size	Male JIC	Male Pipe	Drop Length
04-02	7/16-20	1/8-27	1.17
04-04	7/16-20	1/4-18	1.58
05-02	1/2-20	1/8-27	1.17
05-04	1/2-20	1/4-18	1.58
06-02	9/16-18	1/8-27	1.23
06-04	9/16-18	1/4-18	1.58
06-06	9/16-18	3/8-18	1.82
06-08	9/16-18	1/2-14	2.17
08-04	3/4-16	1/4-18	1.66
08-06	3/4-16	3/8-18	1.82
08-08	3/4-16	1/2-14	2.17
08-12	3/4-16	3/4-14	2.44
10-08	7/8-14	1/2-14	2.17
12-08	1 1/16-12	1/2-14	2.44
12-12	1 1/16-12	3/4-14	2.44
12-16	1 1/16-12	1-11 1/2	3.01
14-12	1 3/16-12	3/4-14	2.59

Dash Size	Male JIC	Male Pipe	Drop Length
16-12	1 5/16-12	3/4-14	2.63
16-16	1 5/16-12	1-11 1/2	3.01
20-20	1 5/8-12	1 1/4-11 1/2	3.69
24-24	1 7/8-12	1 1/2-11 1/2	4.10

2501-L
▼ continued

JIC to Pipe - Extra Long Elbow 90°

Drop Length = Middle of JIC to End of Male Pipe Threads.

SHAPE

90 degree elbow

Dash Size	Male JIC	Male Pipe	Drop Length
04-02	7/16-20	1/8-27	1.56
04-04	7/16-20	1/4-18	2.07
05-02	1/2-20	1/8-27	1.63
05-04	1/2-20	1/4-18	2.07
06-02	9/16-18	1/8-27	1.62
06-04	9/16-18	1/4-18	2.07
06-06	9/16-18	3/8-18	2.42
06-08	9/16-18	1/2-14	2.87
08-04	3/4-16	1/4-18	2.23
08-06	3/4-16	3/8-18	2.42
08-08	3/4-16	1/2-14	2.87
10-08	7/8-14	1/2-14	2.87
12-08	1 1/16-12	1/2-14	3.28
12-12	1 1/16-12	3/4-14	3.28
14-12	1 3/16-12	3/4-14	3.50
16-16	1 5/16-12	1-11 1/2	4.05
20-20	1 5/8-12	1 1/4-11 1/2	5.00
24-24	1 7/8-12	1 1/2-11 1/2	5.55

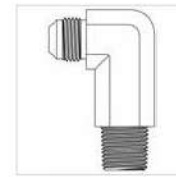

2501-LL

COMPLIANCE
» SAE 071602

AVAILABILITY
» Import Steel
» Steel

JIC to Pipe - Extra Extra Long Elbow 90°

Drop Length = Middle of JIC to End of Male Pipe Threads.

SHAPE

90 degree elbow

Dash Size	Male JIC	Male Pipe	Drop Length
04-02	7/16-20	1/8-27	2.31
04-04	7/16-20	1/4-18	3.00
05-02	1/2-20	1/8-27	2.34
06-04	9/16-18	1/4-18	3.06
06-06	9/16-18	3/8-18	3.75
08-06	3/4-16	3/8-18	3.75
08-08	3/4-16	1/2-14	4.50
10-08	7/8-14	1/2-14	4.50
12-12	1 1/16-12	3/4-14	5.03
16-16	1 5/16-12	1-11 1/2	6.34
20-20	1 5/8-12	1 1/4-11 1/2	7.34



2501-LLL

AVAILABILITY
» Import Steel
» Steel

2501-S

JIC to Pipe Swivel Elbow 90°

Swivel for installation only. May leak at low or residual system pressure. Not intended for use exceeding 212 degrees F.

SHAPE

90 degree elbow

Dash Size	Male JIC	Male Pipe Swivel
04-04	7/16-20	1/4-18
06-04	9/16-18	1/4-18
06-06	9/16-18	3/8-18
08-06	3/4-16	3/8-18
08-08	3/4-16	1/2-14
10-08	7/8-14	1/2-14
12-12	1 1/16-12	3/4-14

AVAILABILITY

- » Import Steel
- » Steel

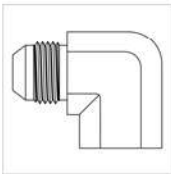
2502

JIC to Pipe Elbow 90°

SHAPE

90 degree elbow

Dash Size	Male JIC	Female Pipe
02-02	5/16-24	1/8-27
03-02	3/8-24	1/8-27
04-02	7/16-20	1/8-27
04-04	7/16-20	1/4-18
04-06	7/16-20	3/8-18
04-08	7/16-20	1/2-14
05-02	1/2-20	1/8-27
05-04	1/2-20	1/4-18
05-06	1/2-20	3/8-18
06-02	9/16-18	1/8-27
06-04	9/16-18	1/4-18
06-06	9/16-18	3/8-18
06-08	9/16-18	1/2-14
08-04	3/4-16	1/4-18
08-06	3/4-16	3/8-18
08-08	3/4-16	1/2-14
08-12	3/4-16	3/4-14
10-06	7/8-14	3/8-18
10-08	7/8-14	1/2-14
12-08	1 1/16-12	1/2-14
12-12	1 1/16-12	3/4-14
12-16	1 1/16-12	1-11 1/2
14-12	1 3/16-12	3/4-14
16-12	1 5/16-12	3/4-14
16-16	1 5/16-12	1-11 1/2
20-20	1 5/8-12	1 1/4-11 1/2
24-24	1 7/8-12	1 1/2-11 1/2
32-32	2 1/2-12	2-11 1/2

AVAILABILITY

- » Import Steel
- » Steel
- » Import Stainless Steel
- » Stainless Steel

COMPLIANCE

- » MS 51506
- » SAE 070203

JIC to Pipe Elbow 45°

SHAPE

45 degree elbow

Dash Size	Male JIC	Male Pipe
02-02	5/16-24	1/8-27
03-02	3/8-24	1/8-27
04-02	7/16-20	1/8-27
04-04	7/16-20	1/4-18
04-06	7/16-20	3/8-18
04-08	7/16-20	1/2-14
05-02	1/2-20	1/8-27
05-04	1/2-20	1/4-18
05-06	1/2-20	3/8-18
06-02	9/16-18	1/8-27
06-04	9/16-18	1/4-18
06-06	9/16-18	3/8-18
06-08	9/16-18	1/2-14
06-12	9/16-18	3/4-14
08-04	3/4-16	1/4-18
08-06	3/4-16	3/8-18
08-08	3/4-16	1/2-14
08-12	3/4-16	3/4-14
10-06	7/8-14	3/8-18
10-08	7/8-14	1/2-14
10-12	7/8-14	3/4-14
12-08	1 1/16-12	1/2-14
12-12	1 1/16-12	3/4-14
12-16	1 1/16-12	1-11 1/2
14-12	1 3/16-12	3/4-14
16-08	1 5/16-12	1/2-14
16-12	1 5/16-12	3/4-14
16-16	1 5/16-12	1-11 1/2
16-20	1 5/16-12	1 1/4-11 1/2
20-16	1 5/8-12	1-11 1/2
20-20	1 5/8-12	1 1/4-11 1/2
20-24	1 5/8-12	1 1/2-11 1/2
24-24	1 7/8-12	1 1/2-11 1/2
32-32	2 1/2-12	2-11 1/2
40-40	3-12	2 1/2-8

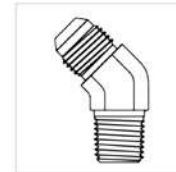

2503

COMPLIANCE

- » MS 51508
- » SAE 070302

AVAILABILITY

- » Import Steel
- » Steel
- » Import Stainless Steel
- » Stainless Steel

JIC Union Elbow 45°

SHAPE

45 degree elbow

Dash Size	Male JIC	Male JIC
04-04	7/16-20	7/16-20
06-04	9/16-18	7/16-20
06-06	9/16-18	9/16-18
08-08	3/4-16	3/4-16
10-10	7/8-14	7/8-14
12-12	1 1/16-12	1 1/16-12
16-16	1 5/16-12	1 5/16-12
20-20	1 5/8-12	1 5/8-12
32-32	2 1/2-12	2 1/2-12

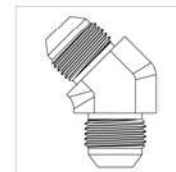

2504

AVAILABILITY

- » Import Steel
- » Steel
- » Stainless Steel

2505

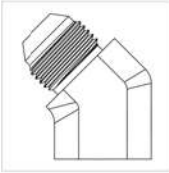

JIC to Pipe Elbow 45°

SHAPE

45 degree elbow

Dash Size	Male JIC	Female Pipe
04-04	7/16-20	1/4-18
06-04	9/16-18	1/4-18
06-06	9/16-18	3/8-18
08-06	3/4-16	3/8-18
08-08	3/4-16	1/2-14
10-08	7/8-14	1/2-14
12-12	1 1/16-12	3/4-14
16-16	1 5/16-12	1-11 1/2
20-20	1 5/8-12	1 1/4-11 1/2

AVAILABILITY

- » Import Steel
- » Steel

2601

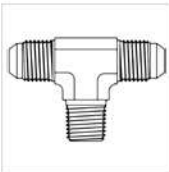

JIC to Pipe Branch Tee

SHAPE

Tee

Dash Size	Male JIC	Male JIC	Male Pipe
03-03-02	3/8-24	3/8-24	1/8-27
04-04-02	7/16-20	7/16-20	1/8-27
04-04-04	7/16-20	7/16-20	1/4-18
04-04-06	7/16-20	7/16-20	3/8-18
05-05-02	1/2-20	1/2-20	1/8-27
05-05-04	1/2-20	1/2-20	1/4-18
06-06-04	9/16-18	9/16-18	1/4-18
06-06-06	9/16-18	9/16-18	3/8-18
06-06-08	9/16-18	9/16-18	1/2-14
08-08-04	3/4-16	3/4-16	1/4-18
08-08-06	3/4-16	3/4-16	3/8-18
08-08-08	3/4-16	3/4-16	1/2-14
08-08-12	3/4-16	3/4-16	3/4-14
10-10-06	7/8-14	7/8-14	3/8-18
10-10-08	7/8-14	7/8-14	1/2-14
10-10-12	7/8-14	7/8-14	3/4-14
12-12-08	1 1/16-12	1 1/16-12	1/2-14
12-12-12	1 1/16-12	1 1/16-12	3/4-14
14-14-12	1 3/16-12	1 3/16-12	3/4-14
16-16-12	1 5/16-12	1 5/16-12	3/4-14
16-16-16	1 5/16-12	1 5/16-12	1-11 1/2
20-20-20	1 5/8-12	1 5/8-12	1 1/4-11 1/2
24-24-24	1 7/8-12	1 7/8-12	1 1/2-11 1/2
32-32-32	2 1/2-12	2 1/2-12	2-11 1/2

AVAILABILITY

- » Import Steel
- » Steel
- » Import Stainless Steel
- » Stainless Steel

COMPLIANCE

- » MS 51512
- » SAE 070425

JIC to Pipe Branch Tee

SHAPE

Tee

Dash Size	Male JIC	Male JIC	Female Pipe
03-03-02	3/8-24	3/8-24	1/8-27
04-04-02	7/16-20	7/16-20	1/8-27
04-04-04	7/16-20	7/16-20	1/4-18
05-05-02	1/2-20	1/2-20	1/8-27
06-06-04	9/16-18	9/16-18	1/4-18
06-06-06	9/16-18	9/16-18	3/8-18
08-06-06	3/4-16	9/16-18	3/8-18
08-08-04	3/4-16	3/4-16	1/4-18
08-08-06	3/4-16	3/4-16	3/8-18
08-08-08	3/4-16	3/4-16	1/2-14
10-10-08	7/8-14	7/8-14	1/2-14
12-12-08	1 1/16-12	1 1/16-12	1/2-14
12-12-12	1 1/16-12	1 1/16-12	3/4-14
14-14-12	1 3/16-12	1 3/16-12	3/4-14
16-16-16	1 5/16-12	1 5/16-12	1-11 1/2
20-20-16	1 5/8-12	1 5/8-12	1-11 1/2
20-20-20	1 5/8-12	1 5/8-12	1 1/4-11 1/2
24-24-24	1 7/8-12	1 7/8-12	1 1/2-11 1/2
32-32-32	2 1/2-12	2 1/2-12	2-11 1/2

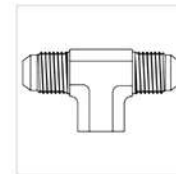

2602

COMPLIANCE

- » MS 51513
- » SAE 070427

AVAILABILITY

- » Import Steel
- » Steel
- » Import Stainless Steel
- » Stainless Steel

JIC Union Tee

SHAPE

Tee

Dash Size	Male JIC	Male JIC	Male JIC
02-02-02	5/16-24	5/16-24	5/16-24
03-03-03	3/8-24	3/8-24	3/8-24
04-04-03	7/16-20	7/16-20	3/8-24
04-04-04	7/16-20	7/16-20	7/16-20
04-04-06	7/16-20	7/16-20	9/16-18
05-05-05	1/2-20	1/2-20	1/2-20
06-06-06	9/16-18	9/16-18	9/16-18
06-06-08	9/16-18	9/16-18	3/4-16
08-06-08	3/4-16	9/16-18	3/4-16
08-08-06	3/4-16	3/4-16	9/16-18
08-08-08	3/4-16	3/4-16	3/4-16
08-08-10	3/4-16	3/4-16	7/8-14
10-08-08	7/8-14	3/4-16	3/4-16
10-10-08	7/8-14	7/8-14	3/4-16
10-10-10	7/8-14	7/8-14	7/8-14
10-10-12	7/8-14	7/8-14	1 1/16-12
12-12-08	1 1/16-12	1 1/16-12	3/4-16
12-12-12	1 1/16-12	1 1/16-12	1 1/16-12
12-12-16	1 1/16-12	1 1/16-12	1 5/16-12
12-16-12	1 1/16-12	1 5/16-12	1 1/16-12
14-14-14	1 3/16-12	1 3/16-12	1 3/16-12
16-16-12	1 5/16-12	1 5/16-12	1 1/16-12
16-16-16	1 5/16-12	1 5/16-12	1 5/16-12
16-16-20	1 5/16-12	1 5/16-12	1 5/8-12
20-16-16	1 5/8-12	1 5/16-12	1 5/16-12
20-20-20	1 5/8-12	1 5/8-12	1 5/8-12

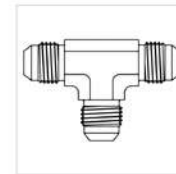

2603

COMPLIANCE

- » MS 51510
- » SAE 070401

AVAILABILITY

- » Import Steel
- » Steel
- » Import Stainless Steel
- » Stainless Steel

▼ 2603 continues

2603
 ▼ continued

Dash Size	Male JIC	Male JIC	Male JIC
24-16-16	1 7/8-12	1 5/16-12	1 5/16-12
24-24-24	1 7/8-12	1 7/8-12	1 7/8-12
32-32-32	2 1/2-12	2 1/2-12	2 1/2-12

2605

JIC to Pipe Run Tee

SHAPE

Tee

Dash Size	Male JIC	Male Pipe	Male JIC
03-02-03	3/8-24	1/8-27	3/8-24
04-02-04	7/16-20	1/8-27	7/16-20
04-04-04	7/16-20	1/4-18	7/16-20
05-02-05	1/2-20	1/8-27	1/2-20
05-04-05	1/2-20	1/4-18	1/2-20
06-02-06	9/16-18	1/8-27	9/16-18
06-04-06	9/16-18	1/4-18	9/16-18
06-06-04	9/16-18	3/8-18	7/16-20
06-06-06	9/16-18	3/8-18	9/16-18
06-08-06	9/16-18	1/2-14	9/16-18
08-04-08	3/4-16	1/4-18	3/4-16
08-06-08	3/4-16	3/8-18	3/4-16
08-08-08	3/4-16	1/2-14	3/4-16
08-12-08	3/4-16	3/4-14	3/4-16
10-08-10	7/8-14	1/2-14	7/8-14
10-12-10	7/8-14	3/4-14	7/8-14
12-08-12	1 1/16-12	1/2-14	1 1/16-12
12-12-08	1 1/16-12	3/4-14	3/4-16
12-12-12	1 1/16-12	3/4-14	1 1/16-12
12-16-12	1 1/16-12	1-11 1/2	1 1/16-12
12-16-16	1 1/16-12	1-11 1/2	1 5/16-12
14-12-14	1 3/16-12	3/4-14	1 3/16-12
16-12-16	1 5/16-12	3/4-14	1 5/16-12
16-16-16	1 5/16-12	1-11 1/2	1 5/16-12
20-20-20	1 5/8-12	1 1/4-11 1/2	1 5/8-12
24-24-24	1 7/8-12	1 1/2-11 1/2	1 7/8-12
32-32-32	2 1/2-12	2-11 1/2	2 1/2-12

AVAILABILITY

- » Import Steel
- » Steel
- » Import Stainless Steel
- » Stainless Steel

COMPLIANCE

- » MS 51511
- » SAE 070424

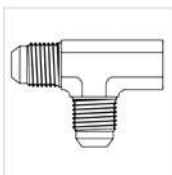
2606

JIC to Pipe Run Tee

SHAPE

Tee

Dash Size	Male JIC	Female Pipe	Male JIC
03-02-03	3/8-24	1/8-27	3/8-24
03-04-03	3/8-24	1/4-18	3/8-24
04-02-04	7/16-20	1/8-27	7/16-20
04-04-04	7/16-20	1/4-18	7/16-20
05-02-05	1/2-20	1/8-27	1/2-20
06-04-06	9/16-18	1/4-18	9/16-18
06-06-06	9/16-18	3/8-18	9/16-18
08-06-08	3/4-16	3/8-18	3/4-16
08-08-08	3/4-16	1/2-14	3/4-16
10-08-10	7/8-14	1/2-14	7/8-14
12-12-12	1 1/16-12	3/4-14	1 1/16-12

AVAILABILITY

- » Import Steel
- » Steel
- » Import Stainless Steel
- » Stainless Steel

COMPLIANCE

- » MS 51514
- » SAE 070426

Dash Size	Male JIC	Female Pipe	Male JIC
14-12-14	1 3/16-12	3/4-14	1 3/16-12
16-16-16	1 5/16-12	1-11 1/2	1 5/16-12
20-20-20	1 5/8-12	1 1/4-11 1/2	1 5/8-12
24-24-24	1 7/8-12	1 1/2-11 1/2	1 7/8-12
32-32-32	2 1/2-12	2-11 1/2	2 1/2-12

2606
▼ continued

JIC to Pipe Run Tee

SHAPE

Tee

Dash Size	Male JIC	Male Pipe	Male Pipe
04-02-02	7/16-20	1/8-27	1/8-27
06-04-04	9/16-18	1/4-18	1/4-18
08-06-06	3/4-16	3/8-18	3/8-18
08-08-08	3/4-16	1/2-14	1/2-14
10-08-08	7/8-14	1/2-14	1/2-14
12-12-12	1 1/16-12	3/4-14	3/4-14
16-16-16	1 5/16-12	1-11 1/2	1-11 1/2
20-20-20	1 5/8-12	1 1/4-11 1/2	1 1/4-11 1/2
24-24-24	1 7/8-12	1 1/2-11 1/2	1 1/2-11 1/2

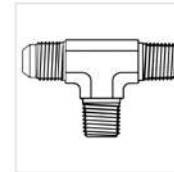

2607

AVAILABILITY

- » Import Steel
- » Steel

JIC to Pipe Run Tee

SHAPE

Tee

Dash Size	Male JIC	Male Pipe	Female Pipe
04-02-02	7/16-20	1/8-27	1/8-27
06-06-06	9/16-18	3/8-18	3/8-18
08-06-06	3/4-16	3/8-18	3/8-18
08-08-08	3/4-16	1/2-14	1/2-14
12-12-12	1 1/16-12	3/4-14	3/4-14
16-16-16	1 5/16-12	1-11 1/2	1-11 1/2
20-20-20	1 5/8-12	1 1/4-11 1/2	1 1/4-11 1/2

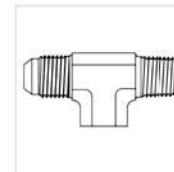

2611

AVAILABILITY

- » Import Steel
- » Steel

JIC Union Cross

SHAPE

Cross

Dash Size	Male JIC	Male JIC	Male JIC	Male JIC
02-02-02-02	5/16-24	5/16-24	5/16-24	5/16-24
04-04-04-04	7/16-20	7/16-20	7/16-20	7/16-20
05-05-05-05	1/2-20	1/2-20	1/2-20	1/2-20
06-06-06-06	9/16-18	9/16-18	9/16-18	9/16-18
08-08-08-08	3/4-16	3/4-16	3/4-16	3/4-16
10-10-10-10	7/8-14	7/8-14	7/8-14	7/8-14
12-12-12-12	1 1/16-12	1 1/16-12	1 1/16-12	1 1/16-12
14-14-14-14	1 3/16-12	1 3/16-12	1 3/16-12	1 3/16-12
16-16-16-16	1 5/16-12	1 5/16-12	1 5/16-12	1 5/16-12
20-20-20-20	1 5/8-12	1 5/8-12	1 5/8-12	1 5/8-12
24-24-24-24	1 7/8-12	1 7/8-12	1 7/8-12	1 7/8-12
32-32-32-32	2 1/2-12	2 1/2-12	2 1/2-12	2 1/2-12

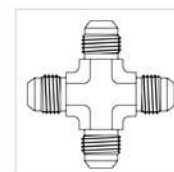

2650

COMPLIANCE

- » MS 51520
- » SAE 070601

AVAILABILITY

- » Import Steel
- » Steel
- » Import Stainless Steel
- » Stainless Steel

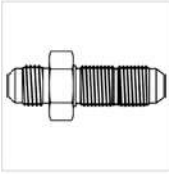
2700

JIC Bulkhead Union

To include locknut with bulkhead fitting, insert "LN" between base part number and dash size.
(Example: 2700-LN-04-04)

SHAPE

Straight

Dash Size	Male JIC	Male JIC
03-03	3/8-24	3/8-24
04-04	7/16-20	7/16-20
05-05	1/2-20	1/2-20
06-06	9/16-18	9/16-18
08-08	3/4-16	3/4-16
10-10	7/8-14	7/8-14
12-12	1 1/16-12	1 1/16-12
14-14	1 3/16-12	1 3/16-12
16-16	1 5/16-12	1 5/16-12
20-20	1 5/8-12	1 5/8-12
24-24	1 7/8-12	1 7/8-12
32-32	2 1/2-12	2 1/2-12

AVAILABILITY

- » Import Steel
- » Steel
- » Import Stainless Steel
- » Stainless Steel

COMPLIANCE

- » MS 51520
- » SAE 070601

2701

JIC Bulkhead Union Elbow 90°

To include locknut with bulkhead fitting, insert "LN" between base part number and dash size.
(Example: 2701-LN-04-04)

SHAPE

90 degree elbow

Dash Size	Male JIC	Male JIC
03-03	3/8-24	3/8-24
04-04	7/16-20	7/16-20
05-05	1/2-20	1/2-20
06-06	9/16-18	9/16-18
08-08	3/4-16	3/4-16
10-10	7/8-14	7/8-14
12-12	1 1/16-12	1 1/16-12
14-14	1 3/16-12	1 3/16-12
16-16	1 5/16-12	1 5/16-12
20-20	1 5/8-12	1 5/8-12
24-24	1 7/8-12	1 7/8-12
32-32	2 1/2-12	2 1/2-12

AVAILABILITY

- » Import Steel
- » Steel
- » Import Stainless Steel
- » Stainless Steel

COMPLIANCE

- » MS 51507
- » SAE 070701

2702

JIC Bulkhead Union Elbow 45°

To include locknut with bulkhead fitting, insert "LN" between base part number and dash size.
(Example: 2702-LN-04-04)

SHAPE

45 degree elbow

Dash Size	Male JIC	Male JIC
03-03	3/8-24	3/8-24
04-04	7/16-20	7/16-20
05-05	1/2-20	1/2-20
06-06	9/16-18	9/16-18
08-08	3/4-16	3/4-16
10-10	7/8-14	7/8-14
12-12	1 1/16-12	1 1/16-12
14-14	1 3/16-12	1 3/16-12

AVAILABILITY

- » Import Steel
- » Steel
- » Import Stainless Steel
- » Stainless Steel

COMPLIANCE

- » MS 51509
- » SAE 070801

Dash Size	Male JIC	Male JIC
16-16	1 5/16-12	1 5/16-12
20-20	1 5/8-12	1 5/8-12
24-24	1 7/8-12	1 7/8-12

2702
▼ continued

JIC Bulkhead Union Branch Tee

To include locknut with bulkhead fitting, insert "LN" between base part number and dash size.
(Example: 2703-LN-04-04)

SHAPE

Tee

Dash Size	Male JIC	Male JIC	Male JIC
03-03-03	3/8-24	3/8-24	3/8-24
04-04-04	7/16-20	7/16-20	7/16-20
05-05-05	1/2-20	1/2-20	1/2-20
06-06-06	9/16-18	9/16-18	9/16-18
08-08-08	3/4-16	3/4-16	3/4-16
10-10-10	7/8-14	7/8-14	7/8-14
12-12-12	1 1/16-12	1 1/16-12	1 1/16-12
16-16-16	1 5/16-12	1 5/16-12	1 5/16-12
20-20-20	1 5/8-12	1 5/8-12	1 5/8-12
24-24-24	1 7/8-12	1 7/8-12	1 7/8-12
32-32-32	2 1/2-12	2 1/2-12	2 1/2-12

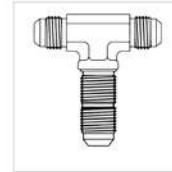

2703

COMPLIANCE

- » MS 51515
- » SAE 070959

AVAILABILITY

- » Import Steel
- » Steel
- » Import Stainless Steel
- » Stainless Steel

JIC Bulkhead Union Run Tee

To include locknut with bulkhead fitting, insert "LN" between base part number and dash size.
(Example: 2704-LN-04-04)

SHAPE

Tee

Dash Size	Male JIC	Male JIC	Male JIC
03-03-03	3/8-24	3/8-24	3/8-24
04-04-04	7/16-20	7/16-20	7/16-20
05-05-05	1/2-20	1/2-20	1/2-20
06-06-06	9/16-18	9/16-18	9/16-18
08-08-08	3/4-16	3/4-16	3/4-16
10-10-10	7/8-14	7/8-14	7/8-14
12-12-12	1 1/16-12	1 1/16-12	1 1/16-12
16-16-16	1 5/16-12	1 5/16-12	1 5/16-12
20-20-20	1 5/8-12	1 5/8-12	1 5/8-12
24-24-24	1 7/8-12	1 7/8-12	1 7/8-12



2704

COMPLIANCE

- » MS 51516
- » SAE 070958

AVAILABILITY

- » Import Steel
- » Steel
- » Import Stainless Steel
- » Stainless Steel

2705

JIC to Pipe Bulkhead

To include locknut with bulkhead fitting, insert "LN" between base part number and dash size.
(Example: 2705-LN-04-04)

SHAPE

Straight

Dash Size	Male JIC	Female Pipe
04-02	7/16-20	1/8-27
04-04	7/16-20	1/4-18
05-02	1/2-20	1/8-27
06-04	9/16-18	1/4-18
06-06	9/16-18	3/8-18
08-06	3/4-16	3/8-18
08-08	3/4-16	1/2-14
10-08	7/8-14	1/2-14
12-12	1 1/16-12	3/4-14
14-12	1 3/16-12	3/4-14
16-16	1 5/16-12	1-11 1/2
20-20	1 5/8-12	1 1/4-11 1/2
24-24	1 7/8-12	1 1/2-11 1/2
32-32	2 1/2-12	2-11 1/2

AVAILABILITY

- » Import Steel
- » Steel
- » Import Stainless Steel
- » Stainless Steel

2706

JIC to Pipe Bulkhead

To include locknut with bulkhead fitting, insert "LN" between base part number and dash size.
(Example: 2706-LN-04-04)

SHAPE

Straight

Dash Size	Male JIC	Male Pipe
04-02	7/16-20	1/8-27
04-04	7/16-20	1/4-18
06-04	9/16-18	1/4-18
06-06	9/16-18	3/8-18
08-06	3/4-16	3/8-18
08-08	3/4-16	1/2-14
10-08	7/8-14	1/2-14
12-08	1 1/16-12	1/2-14
12-12	1 1/16-12	3/4-14
16-16	1 5/16-12	1-11 1/2
20-20	1 5/8-12	1 1/4-11 1/2
24-24	1 7/8-12	1 1/2-11 1/2
32-32	2 1/2-12	2-11 1/2

AVAILABILITY

- » Import Steel
- » Steel
- » Stainless Steel

JIC Short Tube Nut

SHAPE

Nut

Dash Size	Female JIC
04	7/16-20
06	9/16-18
08	3/4-16
10	7/8-14
12	1 1/16-12
16	1 5/16-12
20	1 5/8-12
24	1 7/8-12

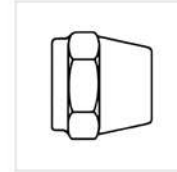

AVAILABILITY
» Steel

JIC Long Tube Nut

SHAPE

Nut

Dash Size	Female JIC
03	3/8-24
04	7/16-20
05	1/2-20
06	9/16-18
08	3/4-16
10	7/8-14
12	1 1/16-12
14	1 3/16-12
16	1 5/16-12
20	1 5/8-12
24	1 7/8-12
32	2 1/2-12

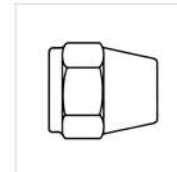

COMPLIANCE
» SAE 070111

AVAILABILITY
» Steel

JIC Cap

SHAPE

Cap

Dash Size	Female JIC
02	5/16-24
03	3/8-24
04	7/16-20
05	1/2-20
06	9/16-18
08	3/4-16
10	7/8-14
12	1 1/16-12
14	1 3/16-12
16	1 5/16-12
20	1 5/8-12
24	1 7/8-12
32	2 1/2-12

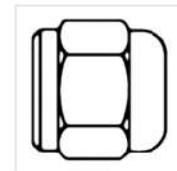

COMPLIANCE
» MS 51532
» SAE 070112

AVAILABILITY
» Import Steel
» Steel
» Import Stainless Steel
» Stainless Steel

306

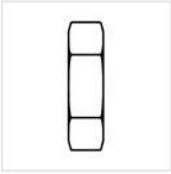

Bulkhead Locknut

To include locknut with bulkhead fitting, add "LN" after base part number. Example: 2700-LN-04-04.

SHAPE

Nut

Dash Size	Female JIC
02	5/16-24
03	3/8-24
04	7/16-20
05	1/2-20
06	9/16-18
08	3/4-16
10	7/8-14
12	1 1/16-12
14	1 3/16-12
16	1 5/16-12
20	1 5/8-12
24	1 7/8-12
32	2 1/2-12

AVAILABILITY

- » Steel
- » Import Stainless Steel
- » Stainless Steel

COMPLIANCE

- » MS 51860
- » SAE 070118

318

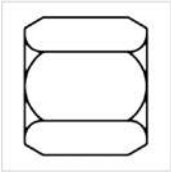

JIC Tube Nut

Sleeve required

SHAPE

Nut

Dash Size	Female JIC
02	5/16-24
03	3/8-24
04	7/16-20
05	1/2-20
06	9/16-18
08	3/4-16
10	7/8-14
12	1 1/16-12
14	1 3/16-12
16	1 5/16-12
20	1 5/8-12
24	1 7/8-12
32	2 1/2-12

AVAILABILITY

- » Import Steel
- » Steel
- » Import Stainless Steel
- » Stainless Steel

COMPLIANCE

- » MS 51531
- » SAE 070110

319

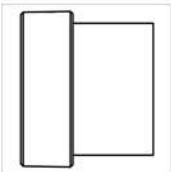

JIC Tube Sleeve

SHAPE

Sleeve

Dash Size	Tube Size
02	1/8
03	3/16
04	1/4
05	5/16
06	3/8
08	1/2
10	5/8
12	3/4
14	7/8
16	1
20	1 1/4

AVAILABILITY

- » Import Steel
- » Steel
- » Import Stainless Steel
- » Stainless Steel

COMPLIANCE

- » MS 51532
- » SAE 070115

Dash Size	Tube Size
24	1 1/2
32	2

319
▼ continued

Braze-On to JIC

Use with silver braze ring. Order SBR and size (e.g. SBR04)

SHAPE

Straight

Dash Size	Braze Port	Male JIC
04-04	1/4	7/16-20
05-05	5/16	1/2-20
06-04	3/8	7/16-20
06-06	3/8	9/16-18
06-08	3/8	3/4-16
08-06	1/2	9/16-18
08-08	1/2	3/4-16
10-08	5/8	3/4-16
10-10	5/8	7/8-14
10-12	5/8	1 1/16-12
12-08	3/4	3/4-16
12-10	3/4	7/8-14
12-12	3/4	1 1/16-12
12-16	3/4	1 5/16-12
14-14	7/8	1 3/16-12
16-12	1	1 1/16-12
16-16	1	1 5/16-12
16-20	1	1 5/8-12
20-16	1 1/4	1 5/16-12
20-20	1 1/4	1 5/8-12
24-16	1 1/2	1 5/16-12
24-20	1 1/2	1 5/8-12
24-24	1 1/2	1 7/8-12
32-32	2	2 1/2-12

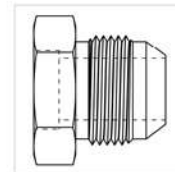

403

- AVAILABILITY**
- » Import Steel
 - » Steel
 - » Stainless Steel

Flareless JIC Tube Nut

Sleeve is required. "NO-FLARE" NUT AND SLEEVE SHOULD NOT BE USED WITH STAINLESS TUBING. USE ONLY WITH SAE J524, J525, J527 OR J356 CARBON STEEL.

SHAPE

Nut

Dash Size	Female JIC
03	3/8-24
04	7/16-20
05	1/2-20
06	9/16-18
08	3/4-16
10	7/8-14
12	1 1/16-12
16	1 5/16-12
20	1 5/8-12
24	1 7/8-12
32	2 1/2-12

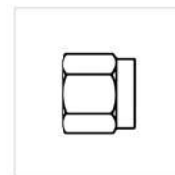

418

- AVAILABILITY**
- » Import Steel
 - » Steel

419

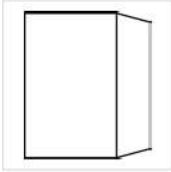

Flareless JIC Tube Sleeve

"NO-FLARE" NUT AND SLEEVE SHOULD NOT BE USED WITH STAINLESS TUBING. USE ONLY WITH SAE J524, J525, J527 OR J356 CARBON STEEL.

SHAPE

Sleeve

Dash Size	Tube Size
03	3/16
04	1/4
05	5/16
06	3/8
08	1/2
10	5/8
12	3/4
16	1
20	1 1/4
24	1 1/2
32	2

AVAILABILITY

» Steel

500



Braze Port to JIC Elbow 90°

Use with silver braze ring. Order SBR and size (e.g. SBR04).

SHAPE

90 degree elbow

Dash Size	Braze Port	Male JIC
04-04	1/4	7/16-20
06-06	3/8	9/16-18
08-08	1/2	3/4-16
10-10	5/8	7/8-14
12-12	3/4	1 1/16-12
16-16	1	1 5/16-12
20-20	1 1/4	1 5/8-12
24-24	1 1/2	1 7/8-12

AVAILABILITY

» Import Steel

» Steel

6400



JIC to O-Ring

RST - Available in restricted orifice, contact a Customer Service Representative at (800) 255-1008 for availability.

SHAPE

Straight

Dash Size	Male JIC	Male O-Ring
02-02	5/16-24	5/16-24
03-02	3/8-24	5/16-24
03-03	3/8-24	3/8-24
03-06	3/8-24	9/16-18
04-02	7/16-20	5/16-24
04-03	7/16-20	3/8-24
04-04	7/16-20	7/16-20
04-05	7/16-20	1/2-20
04-06	7/16-20	9/16-18
04-08	7/16-20	3/4-16
04-10	7/16-20	7/8-14
04-12	7/16-20	1 1/16-12
05-02	1/2-20	5/16-24
05-04	1/2-20	7/16-20
05-05	1/2-20	1/2-20
05-06	1/2-20	9/16-18
05-08	1/2-20	3/4-16

AVAILABILITY

» Import Steel

» Steel

» Import Stainless Steel

» Stainless Steel

COMPLIANCE

» MS 51525

» SAE 070120

Dash Size	Male JIC	Male O-Ring
06-04	9/16-18	7/16-20
06-05	9/16-18	1/2-20
06-06	9/16-18	9/16-18
06-08	9/16-18	3/4-16
06-10	9/16-18	7/8-14
06-12	9/16-18	1 1/16-12
06-16	9/16-18	1 5/16-12
08-04	3/4-16	7/16-20
08-05	3/4-16	1/2-20
08-06	3/4-16	9/16-18
08-08	3/4-16	3/4-16
08-10	3/4-16	7/8-14
08-12	3/4-16	1 1/16-12
08-14	3/4-16	1 3/16-12
08-16	3/4-16	1 5/16-12
08-24	3/4-16	1 7/8-12
10-04	7/8-14	7/16-20
10-06	7/8-14	9/16-18
10-08	7/8-14	3/4-16
10-10	7/8-14	7/8-14
10-12	7/8-14	1 1/16-12
10-14	7/8-14	1 3/16-12
10-16	7/8-14	1 5/16-12
10-20	7/8-14	1 5/8-12
12-04	1 1/16-12	7/16-20
12-06	1 1/16-12	9/16-18
12-08	1 1/16-12	3/4-16
12-10	1 1/16-12	7/8-14
12-12	1 1/16-12	1 1/16-12
12-14	1 1/16-12	1 3/16-12
12-16	1 1/16-12	1 5/16-12
12-20	1 1/16-12	1 5/8-12
12-24	1 1/16-12	1 7/8-12
14-10	1 3/16-12	7/8-14
14-12	1 3/16-12	1 1/16-12
14-14	1 3/16-12	1 3/16-12
14-16	1 3/16-12	1 5/16-12
16-08	1 5/16-12	3/4-16
16-10	1 5/16-12	7/8-14
16-12	1 5/16-12	1 1/16-12
16-14	1 5/16-12	1 3/16-12
16-16	1 5/16-12	1 5/16-12
16-20	1 5/16-12	1 5/8-12
16-24	1 5/16-12	1 7/8-12
20-12	1 5/8-12	1 1/16-12
20-16	1 5/8-12	1 5/16-12
20-20	1 5/8-12	1 5/8-12
20-24	1 5/8-12	1 7/8-12
20-32	1 5/8-12	2 1/2-12
24-16	1 7/8-12	1 5/16-12
24-20	1 7/8-12	1 5/8-12
24-24	1 7/8-12	1 7/8-12
24-32	1 7/8-12	2 1/2-12
32-20	2 1/2-12	1 5/8-12
32-24	2 1/2-12	1 7/8-12
32-32	2 1/2-12	2 1/2-12

6400

▼ continued

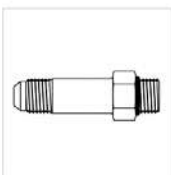
6400-L**JIC to O-Ring - Long**

SHAPE

Straight

Dash Size	Male JIC	Male O-Ring	Overall Adapter Length (OAL)
04-04	7/16-20	7/16-20	2.08
05-05	1/2-20	1/2-20	2.14
06-06	9/16-18	9/16-18	2.31
06-08	9/16-18	3/4-16	2.60
08-08	3/4-16	3/4-16	2.70
08-10	3/4-16	7/8-14	2.94
10-10	7/8-14	7/8-14	3.04
12-10	1 1/16-12	7/8-14	3.52
12-12	1 1/16-12	1 1/16-12	3.61
12-16	1 1/16-12	1 5/16-12	3.93
14-14	1 3/16-12	1 3/16-12	3.80
16-12	1 5/16-12	1 1/16-12	3.98
16-16	1 5/16-12	1 5/16-12	3.98
20-16	1 5/8-12	1 5/16-12	4.85
20-20	1 5/8-12	1 5/8-12	4.69
24-24	1 7/8-12	1 7/8-12	5.17

AVAILABILITY

- » Import Steel
- » Steel
- » Import Stainless Steel
- » Stainless Steel

COMPLIANCE

- » MS 51526
- » SAE 070122

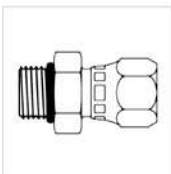
6402**O-Ring to JIC Swivel**

SHAPE

Straight

Dash Size	Male O-Ring	Female JIC Swivel
04-04	7/16-20	7/16-20
05-05	1/2-20	1/2-20
06-04	9/16-18	7/16-20
06-06	9/16-18	9/16-18
06-08	9/16-18	3/4-16
08-06	3/4-16	9/16-18
08-08	3/4-16	3/4-16
08-10	3/4-16	7/8-14
10-08	7/8-14	3/4-16
10-10	7/8-14	7/8-14
10-12	7/8-14	1 1/16-12
12-10	1 1/16-12	7/8-14
12-12	1 1/16-12	1 1/16-12
12-16	1 1/16-12	1 5/16-12
14-14	1 3/16-12	1 3/16-12
16-12	1 5/16-12	1 1/16-12
16-16	1 5/16-12	1 5/16-12
16-20	1 5/16-12	1 5/8-12
20-20	1 5/8-12	1 5/8-12
24-24	1 7/8-12	1 7/8-12

AVAILABILITY

- » Import Steel
- » Steel
- » Import Stainless Steel
- » Stainless Steel

JIC Swivel Elbow 90°

SHAPE

90 degree elbow

Dash Size	Male JIC	Female JIC Swivel
02-02	5/16-24	5/16-24
03-03	3/8-24	3/8-24
04-04	7/16-20	7/16-20
04-06	7/16-20	9/16-18
05-05	1/2-20	1/2-20
06-04	9/16-18	7/16-20
06-06	9/16-18	9/16-18
06-08	9/16-18	3/4-16
08-06	3/4-16	9/16-18
08-08	3/4-16	3/4-16
08-10	3/4-16	7/8-14
08-12	3/4-16	1 1/16-12
10-08	7/8-14	3/4-16
10-10	7/8-14	7/8-14
10-12	7/8-14	1 1/16-12
12-10	1 1/16-12	7/8-14
12-12	1 1/16-12	1 1/16-12
12-16	1 1/16-12	1 5/16-12
14-14	1 3/16-12	1 3/16-12
16-12	1 5/16-12	1 1/16-12
16-16	1 5/16-12	1 5/16-12
20-20	1 5/8-12	1 5/8-12
24-24	1 7/8-12	1 7/8-12
32-32	2 1/2-12	2 1/2-12

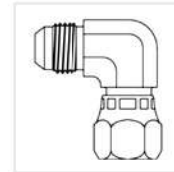

6500

COMPLIANCE

- » MS 51521
- » SAE 070221

AVAILABILITY

- » Import Steel
- » Steel
- » Import Stainless Steel
- » Stainless Steel

JIC Swivel to Pipe Elbow 90°

SHAPE

90 degree elbow

Dash Size	Female JIC Swivel	Male Pipe
04-02	7/16-20	1/8-27
04-04	7/16-20	1/4-18
04-06	7/16-20	3/8-18
05-02	1/2-20	1/8-27
05-04	1/2-20	1/4-18
06-04	9/16-18	1/4-18
06-06	9/16-18	3/8-18
06-08	9/16-18	1/2-14
08-06	3/4-16	3/8-18
08-08	3/4-16	1/2-14
08-12	3/4-16	3/4-14
10-08	7/8-14	1/2-14
12-08	1 1/16-12	1/2-14
12-12	1 1/16-12	3/4-14
14-12	1 3/16-12	3/4-14
16-16	1 5/16-12	1-11 1/2
20-20	1 5/8-12	1 1/4-11 1/2
24-24	1 7/8-12	1 1/2-11 1/2
32-32	2 1/2-12	2-11 1/2

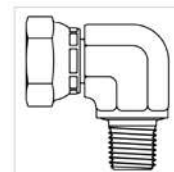

6501

AVAILABILITY

- » Import Steel
- » Steel
- » Import Stainless Steel
- » Stainless Steel

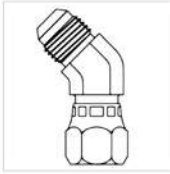
6502**JIC Swivel Elbow 45°**

SHAPE

45 degree elbow

AVAILABILITY

- » Import Steel
- » Steel
- » Import Stainless Steel
- » Stainless Steel

COMPLIANCE

- » MS 51522
- » SAE 070321

Dash Size	Male JIC	Female JIC Swivel
02-02	5/16-24	5/16-24
03-03	3/8-24	3/8-24
04-04	7/16-20	7/16-20
05-05	1/2-20	1/2-20
06-06	9/16-18	9/16-18
08-08	3/4-16	3/4-16
10-10	7/8-14	7/8-14
12-12	1 1/16-12	1 1/16-12
14-14	1 3/16-12	1 3/16-12
16-12	1 5/16-12	1 1/16-12
16-16	1 5/16-12	1 5/16-12
20-20	1 5/8-12	1 5/8-12
24-24	1 7/8-12	1 7/8-12
32-32	2 1/2-12	2 1/2-12

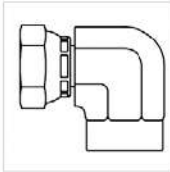
6503**JIC Swivel to Pipe Elbow 90°**

SHAPE

90 degree elbow

AVAILABILITY

- » Import Steel
- » Steel

Dash Size	Female JIC Swivel	Female Pipe
04-04	7/16-20	1/4-18
04-06	7/16-20	3/8-18
06-04	9/16-18	1/4-18
06-06	9/16-18	3/8-18
06-08	9/16-18	1/2-14
08-06	3/4-16	3/8-18
08-08	3/4-16	1/2-14
10-08	7/8-14	1/2-14
12-04	1 1/16-12	1/4-18
12-12	1 1/16-12	3/4-14
16-16	1 5/16-12	1-11 1/2
20-20	1 5/8-12	1 1/4-11 1/2

JIC Swivel Extender

SHAPE

Straight

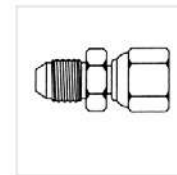

6504

Dash Size	Male JIC	Female JIC Swivel
03-04	3/8-24	7/16-20
04-04	7/16-20	7/16-20
04-05	7/16-20	1/2-20
05-05	1/2-20	1/2-20
06-04	9/16-18	7/16-20
06-05	9/16-18	1/2-20
06-06	9/16-18	9/16-18
06-08	9/16-18	3/4-16
08-06	3/4-16	9/16-18
08-08	3/4-16	3/4-16
08-10	3/4-16	7/8-14
10-10	7/8-14	7/8-14
10-12	7/8-14	1 1/16-12
12-12	1 1/16-12	1 1/16-12
16-16	1 5/16-12	1 5/16-12
20-20	1 5/8-12	1 5/8-12
24-24	1 7/8-12	1 7/8-12
32-32	2 1/2-12	2 1/2-12

AVAILABILITY

- » Import Steel
- » Steel
- » Stainless Steel

JIC Swivel to Pipe

SHAPE

Straight

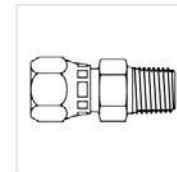

6505

Dash Size	Female JIC Swivel	Male Pipe
02-04	5/16-24	1/4-18
04-02	7/16-20	1/8-27
04-04	7/16-20	1/4-18
04-06	7/16-20	3/8-18
05-02	1/2-20	1/8-27
05-04	1/2-20	1/4-18
06-04	9/16-18	1/4-18
06-06	9/16-18	3/8-18
06-08	9/16-18	1/2-14
08-04	3/4-16	1/4-18
08-06	3/4-16	3/8-18
08-08	3/4-16	1/2-14
08-12	3/4-16	3/4-14
10-06	7/8-14	3/8-18
10-08	7/8-14	1/2-14
10-12	7/8-14	3/4-14
12-08	1 1/16-12	1/2-14
12-12	1 1/16-12	3/4-14
16-08	1 5/16-12	1/2-14
16-12	1 5/16-12	3/4-14
16-16	1 5/16-12	1-11 1/2
20-20	1 5/8-12	1 1/4-11 1/2
24-24	1 7/8-12	1 1/2-11 1/2
32-32	2 1/2-12	2-11 1/2
40-40	3-12	2 1/2-8

AVAILABILITY

- » Import Steel
- » Steel
- » Import Stainless Steel
- » Stainless Steel

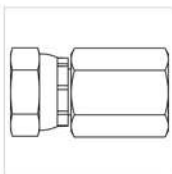
6506**JIC Swivel to Pipe**

SHAPE

Straight

Dash Size	Female JIC Swivel	Female Pipe
02-04	5/16-24	1/4-18
04-02	7/16-20	1/8-27
04-04	7/16-20	1/4-18
05-04	1/2-20	1/4-18
06-04	9/16-18	1/4-18
06-06	9/16-18	3/8-18
06-08	9/16-18	1/2-14
08-04	3/4-16	1/4-18
08-06	3/4-16	3/8-18
08-08	3/4-16	1/2-14
10-06	7/8-14	3/8-18
10-08	7/8-14	1/2-14
10-12	7/8-14	3/4-14
12-08	1 1/16-12	1/2-14
12-12	1 1/16-12	3/4-14
14-12	1 3/16-12	3/4-14
16-16	1 5/16-12	1-11 1/2
20-20	1 5/8-12	1 1/4-11 1/2
24-24	1 7/8-12	1 1/2-11 1/2
32-32	2 1/2-12	2-11 1/2

AVAILABILITY

- » Import Steel
- » Steel
- » Import Stainless Steel
- » Stainless Steel

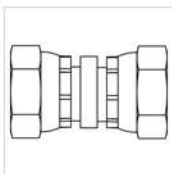
6510**JIC Swivel Union**

SHAPE

Straight

Dash Size	Female JIC Swivel	Female JIC Swivel
02-02	5/16-24	5/16-24
04-04	7/16-20	7/16-20
06-06	9/16-18	9/16-18
08-06	3/4-16	9/16-18
08-08	3/4-16	3/4-16
10-10	7/8-14	7/8-14
12-12	1 1/16-12	1 1/16-12
16-16	1 5/16-12	1 5/16-12
20-20	1 5/8-12	1 5/8-12
24-24	1 7/8-12	1 7/8-12
32-32	2 1/2-12	2 1/2-12

AVAILABILITY

- » Import Steel
- » Steel
- » Stainless Steel

JIC Swivel Branch Tee

SHAPE

Tee

Dash Size	Male JIC	Male JIC	Female JIC Swivel
03-03-03	3/8-24	3/8-24	3/8-24
04-04-04	7/16-20	7/16-20	7/16-20
05-05-05	1/2-20	1/2-20	1/2-20
06-06-06	9/16-18	9/16-18	9/16-18
06-06-08	9/16-18	9/16-18	3/4-16
08-08-08	3/4-16	3/4-16	3/4-16
10-10-10	7/8-14	7/8-14	7/8-14
12-12-12	1 1/16-12	1 1/16-12	1 1/16-12
14-14-14	1 3/16-12	1 3/16-12	1 3/16-12
16-16-16	1 5/16-12	1 5/16-12	1 5/16-12
20-20-20	1 5/8-12	1 5/8-12	1 5/8-12
24-24-24	1 7/8-12	1 7/8-12	1 7/8-12
32-32-32	2 1/2-12	2 1/2-12	2 1/2-12

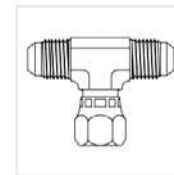

6600

COMPLIANCE

- » MS 51524
- » SAE 070433

AVAILABILITY

- » Import Steel
- » Steel
- » Import Stainless Steel
- » Stainless Steel

JIC Swivel Run Tee

SHAPE

Tee

Dash Size	Male JIC	Female JIC Swivel	Male JIC
03-03-03	3/8-24	3/8-24	3/8-24
04-04-04	7/16-20	7/16-20	7/16-20
05-05-05	1/2-20	1/2-20	1/2-20
06-06-06	9/16-18	9/16-18	9/16-18
08-08-08	3/4-16	3/4-16	3/4-16
10-10-10	7/8-14	7/8-14	7/8-14
12-12-08	1 1/16-12	1 1/16-12	3/4-16
12-12-12	1 1/16-12	1 1/16-12	1 1/16-12
14-14-14	1 3/16-12	1 3/16-12	1 3/16-12
16-16-04	1 5/16-12	1 5/16-12	7/16-20
16-16-08	1 5/16-12	1 5/16-12	3/4-16
16-16-16	1 5/16-12	1 5/16-12	1 5/16-12
20-20-20	1 5/8-12	1 5/8-12	1 5/8-12
24-24-24	1 7/8-12	1 7/8-12	1 7/8-12
32-32-32	2 1/2-12	2 1/2-12	2 1/2-12

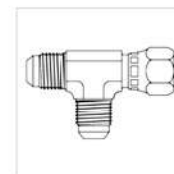

6602

COMPLIANCE

- » MS 51523
- » SAE 070432

AVAILABILITY

- » Import Steel
- » Steel
- » Import Stainless Steel
- » Stainless Steel

Swivel Branch Tee

SHAPE

Tee

Dash Size	Female JIC Swivel	Female JIC Swivel	Male JIC
04-04-04	7/16-20	7/16-20	7/16-20
06-06-06	9/16-18	9/16-18	9/16-18
08-08-08	3/4-16	3/4-16	3/4-16
10-10-10	7/8-14	7/8-14	7/8-14
12-12-12	1 1/16-12	1 1/16-12	1 1/16-12
16-16-16	1 5/16-12	1 5/16-12	1 5/16-12

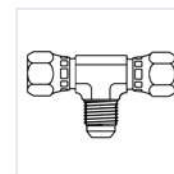

6603

AVAILABILITY

- » Import Steel
- » Steel

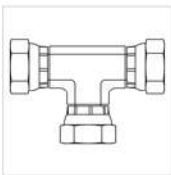
6606**JIC Swivel Union Tee**

SHAPE

Tee

Dash Size	Female JIC Swivel	Female JIC Swivel	Female JIC Swivel
04-04-04	7/16-20	7/16-20	7/16-20
06-06-06	9/16-18	9/16-18	9/16-18
08-08-08	3/4-16	3/4-16	3/4-16
10-10-10	7/8-14	7/8-14	7/8-14
12-12-12	1 1/16-12	1 1/16-12	1 1/16-12
16-16-16	1 5/16-12	1 5/16-12	1 5/16-12

AVAILABILITY

- » Import Steel
- » Steel

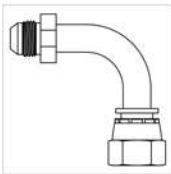
6701**JIC Swivel Bent Tube Elbow 90°**

SHAPE

90 degree elbow

Dash Size	Male JIC	Female JIC Swivel
04-04	7/16-20	7/16-20
05-05	1/2-20	1/2-20
06-06	9/16-18	9/16-18
08-08	3/4-16	3/4-16
10-10	7/8-14	7/8-14
12-12	1 1/16-12	1 1/16-12
16-16	1 5/16-12	1 5/16-12
20-20	1 5/8-12	1 5/8-12
24-24	1 7/8-12	1 7/8-12

AVAILABILITY

- » Steel

6701-L**JIC Swivel Bent Tube- Long Elbow 90°**

SHAPE

90 degree elbow

Dash Size	Male JIC	Female JIC Swivel
04-04	7/16-20	7/16-20
06-06	9/16-18	9/16-18
08-08	3/4-16	3/4-16
10-10	7/8-14	7/8-14
12-12	1 1/16-12	1 1/16-12
16-16	1 5/16-12	1 5/16-12
20-20	1 5/8-12	1 5/8-12

AVAILABILITY

- » Steel

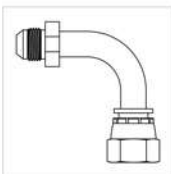
6701-XH**JIC Swivel High Pressure Bent Tube Elbow 90°**

Meets SAE 100R10 pressures.

SHAPE

90 degree elbow

Dash Size	Male JIC	Female JIC Swivel
08-08	3/4-16	3/4-16
12-12	1 1/16-12	1 1/16-12
16-16	1 5/16-12	1 5/16-12
20-20	1 5/8-12	1 5/8-12
24-24	1 7/8-12	1 7/8-12

AVAILABILITY

- » Steel

JIC Swivel High Pressure Bent Tube Long Elbow 90°

Meets SAE 100R10 pressures.

SHAPE

90 degree elbow

Dash Size	Male JIC	Female JIC Swivel
08-08	3/4-16	3/4-16
12-12	1 1/16-12	1 1/16-12
16-16	1 5/16-12	1 5/16-12
20-20	1 5/8-12	1 5/8-12



6701-LXH

AVAILABILITY

» Steel

JIC Swivel Bent Tube Elbow 45°

SHAPE

45 degree elbow

Dash Size	Male JIC	Female JIC Swivel
06-06	9/16-18	9/16-18
08-08	3/4-16	3/4-16
10-10	7/8-14	7/8-14
12-12	1 1/16-12	1 1/16-12
16-16	1 5/16-12	1 5/16-12



6702

AVAILABILITY

» Steel

JIC to O-Ring Elbow 90°

RST - Available in restricted orifice, contact a Customer Service Representative at (800) 255-1008 for availability.

SHAPE

90 degree elbow

Dash Size	Male JIC	Male O-Ring
02-02	5/16-24	5/16-24
03-03	3/8-24	3/8-24
04-02	7/16-20	5/16-24
04-03	7/16-20	3/8-24
04-04	7/16-20	7/16-20
04-05	7/16-20	1/2-20
04-06	7/16-20	9/16-18
04-08	7/16-20	3/4-16
04-10	7/16-20	7/8-14
05-04	1/2-20	7/16-20
05-05	1/2-20	1/2-20
05-06	1/2-20	9/16-18
05-08	1/2-20	3/4-16
06-04	9/16-18	7/16-20
06-05	9/16-18	1/2-20
06-06	9/16-18	9/16-18
06-08	9/16-18	3/4-16
06-10	9/16-18	7/8-14
06-12	9/16-18	1 1/16-12
08-04	3/4-16	7/16-20
08-06	3/4-16	9/16-18
08-08	3/4-16	3/4-16
08-10	3/4-16	7/8-14
08-12	3/4-16	1 1/16-12
08-16	3/4-16	1 5/16-12
10-06	7/8-14	9/16-18
10-08	7/8-14	3/4-16

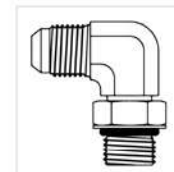

6801

COMPLIANCE

» MS 51527
» SAE 070220

AVAILABILITY

» Import Steel
» Steel
» Import Stainless Steel
» Stainless Steel

▼ 6801 continues

6801
 ▼ continued

Dash Size	Male JIC	Male O-Ring
10-10	7/8-14	7/8-14
10-12	7/8-14	1 1/16-12
10-16	7/8-14	1 5/16-12
12-06	1 1/16-12	9/16-18
12-08	1 1/16-12	3/4-16
12-10	1 1/16-12	7/8-14
12-12	1 1/16-12	1 1/16-12
12-14	1 1/16-12	1 3/16-12
12-16	1 1/16-12	1 5/16-12
12-20	1 1/16-12	1 5/8-12
14-12	1 3/16-12	1 1/16-12
14-14	1 3/16-12	1 3/16-12
14-16	1 3/16-12	1 5/16-12
16-08	1 5/16-12	3/4-16
16-10	1 5/16-12	7/8-14
16-12	1 5/16-12	1 1/16-12
16-14	1 5/16-12	1 3/16-12
16-16	1 5/16-12	1 5/16-12
16-20	1 5/16-12	1 5/8-12
16-24	1 5/16-12	1 7/8-12
20-12	1 5/8-12	1 1/16-12
20-14	1 5/8-12	1 3/16-12
20-16	1 5/8-12	1 5/16-12
20-20	1 5/8-12	1 5/8-12
20-24	1 5/8-12	1 7/8-12
24-16	1 7/8-12	1 5/16-12
24-20	1 7/8-12	1 5/8-12
24-24	1 7/8-12	1 7/8-12
24-32	1 7/8-12	2 1/2-12
32-20	2 1/2-12	1 5/8-12
32-24	2 1/2-12	1 7/8-12
32-32	2 1/2-12	2 1/2-12

6801-L

JIC to O-Ring - Long Elbow 90°

Drop Length = Middle of JIC to End of Male O-Ring Threads.

SHAPE

90 degree elbow

Dash Size	Male JIC	Male O-Ring	Drop Length
04-04	7/16-20	7/16-20	1.19
04-06	7/16-20	9/16-18	1.66
06-06	9/16-18	9/16-18	1.66
06-08	9/16-18	3/4-16	1.81
06-10	9/16-18	7/8-14	2.16
08-06	3/4-16	9/16-18	1.75
08-08	3/4-16	3/4-16	1.81
08-10	3/4-16	7/8-14	2.16
10-08	7/8-14	3/4-16	2.10
10-10	7/8-14	7/8-14	2.16
12-12	1 1/16-12	1 1/16-12	2.47
16-16	1 5/16-12	1 5/16-12	3.06
20-20	1 5/8-12	1 5/8-12	3.48

AVAILABILITY

- » Import Steel
- » Steel

JIC to O-Ring - Extra Long Elbow 90°

Drop Length = Middle of JIC to End of Male O-Ring Threads.

SHAPE

90 degree elbow

Dash Size	Male JIC	Male O-Ring	Drop Length
04-04	7/16-20	7/16-20	1.73
04-06	7/16-20	9/16-18	2.25
06-06	9/16-18	9/16-18	2.08
06-08	9/16-18	3/4-16	2.49
08-06	3/4-16	9/16-18	2.35
08-08	3/4-16	3/4-16	2.48
08-10	3/4-16	7/8-14	3.25
10-08	7/8-14	3/4-16	2.56
10-10	7/8-14	7/8-14	3.25
12-08	1 1/16-12	3/4-16	2.67
12-12	1 1/16-12	1 1/16-12	3.34
16-12	1 5/16-12	1 1/16-12	3.47
16-16	1 5/16-12	1 5/16-12	3.72
20-20	1 5/8-12	1 5/8-12	4.41



6801-LL

AVAILABILITY

- » Import Steel
- » Steel

JIC to O-Ring - Extra Extra Long Elbow 90°

Drop Length = Middle of JIC to End of Male O-Ring Threads.

SHAPE

90 degree elbow

Dash Size	Male JIC	Male O-Ring	Drop Length
04-04	7/16-20	7/16-20	2.44
06-06	9/16-18	9/16-18	3.06
06-08	9/16-18	3/4-16	3.53
08-08	3/4-16	3/4-16	3.53
10-10	7/8-14	7/8-14	3.69
12-08	1 1/16-12	3/4-16	3.69



6801-LLL

AVAILABILITY

- » Import Steel
- » Steel

JIC to O-Ring Swivel Elbow 90°

Swivel for installation only. May leak at low or residual system pressure. Not intended for use exceeding 212 degrees Fahrenheit.

SHAPE

90 degree elbow

Dash Size	Male JIC	Male O-Ring
06-06	9/16-18	9/16-18
08-08	3/4-16	3/4-16
10-10	7/8-14	7/8-14

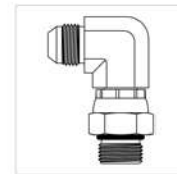

6801-S

AVAILABILITY

- » Import Steel
- » Steel

6802



JIC to O-Ring Elbow 45°

SHAPE

45 degree elbow

AVAILABILITY

- » Import Steel
- » Steel
- » Import Stainless Steel
- » Stainless Steel

COMPLIANCE

- » MS 51528
- » SAE 070320

Dash Size	Male JIC	Male O-Ring
02-02	5/16-24	5/16-24
03-03	3/8-24	3/8-24
04-04	7/16-20	7/16-20
04-05	7/16-20	1/2-20
04-06	7/16-20	9/16-18
04-08	7/16-20	3/4-16
05-04	1/2-20	7/16-20
05-05	1/2-20	1/2-20
05-06	1/2-20	9/16-18
05-08	1/2-20	3/4-16
06-04	9/16-18	7/16-20
06-05	9/16-18	1/2-20
06-06	9/16-18	9/16-18
06-08	9/16-18	3/4-16
06-10	9/16-18	7/8-14
06-12	9/16-18	1 1/16-12
08-06	3/4-16	9/16-18
08-08	3/4-16	3/4-16
08-10	3/4-16	7/8-14
08-12	3/4-16	1 1/16-12
08-16	3/4-16	1 5/16-12
10-08	7/8-14	3/4-16
10-10	7/8-14	7/8-14
10-12	7/8-14	1 1/16-12
12-08	1 1/16-12	3/4-16
12-10	1 1/16-12	7/8-14
12-12	1 1/16-12	1 1/16-12
12-14	1 1/16-12	1 3/16-12
12-16	1 1/16-12	1 5/16-12
14-14	1 3/16-12	1 3/16-12
16-12	1 5/16-12	1 1/16-12
16-16	1 5/16-12	1 5/16-12
16-20	1 5/16-12	1 5/8-12
20-16	1 5/8-12	1 5/16-12
20-20	1 5/8-12	1 5/8-12
20-24	1 5/8-12	1 7/8-12
24-20	1 7/8-12	1 5/8-12
24-24	1 7/8-12	1 7/8-12
32-32	2 1/2-12	2 1/2-12

JIC to O-Ring Branch Tee

SHAPE

Tee



6803

Dash Size	Male JIC	Male JIC	Male O-Ring
04-04-04	7/16-20	7/16-20	7/16-20
04-04-06	7/16-20	7/16-20	9/16-18
05-05-05	1/2-20	1/2-20	1/2-20
05-05-06	1/2-20	1/2-20	9/16-18
06-06-06	9/16-18	9/16-18	9/16-18
06-06-08	9/16-18	9/16-18	3/4-16
06-08-08	9/16-18	3/4-16	3/4-16
08-06-08	3/4-16	9/16-18	3/4-16
08-08-06	3/4-16	3/4-16	9/16-18
08-08-08	3/4-16	3/4-16	3/4-16
08-08-10	3/4-16	3/4-16	7/8-14
08-08-12	3/4-16	3/4-16	1 1/16-12
10-10-08	7/8-14	7/8-14	3/4-16
10-10-10	7/8-14	7/8-14	7/8-14
12-12-08	1 1/16-12	1 1/16-12	3/4-16
12-12-10	1 1/16-12	1 1/16-12	7/8-14
12-12-12	1 1/16-12	1 1/16-12	1 1/16-12
12-12-16	1 1/16-12	1 1/16-12	1 5/16-12
14-14-14	1 3/16-12	1 3/16-12	1 3/16-12
16-16-12	1 5/16-12	1 5/16-12	1 1/16-12
16-16-16	1 5/16-12	1 5/16-12	1 5/16-12
20-20-20	1 5/8-12	1 5/8-12	1 5/8-12
24-24-24	1 7/8-12	1 7/8-12	1 7/8-12
32-32-32	2 1/2-12	2 1/2-12	2 1/2-12

COMPLIANCE

- » MS 51529
- » SAE 070429

AVAILABILITY

- » Import Steel
- » Steel
- » Import Stainless Steel
- » Stainless Steel

6804



JIC to O-Ring Run Tee

SHAPE

Tee

Dash Size	Male JIC	Male O-Ring	Male JIC
04-04-04	7/16-20	7/16-20	7/16-20
04-06-04	7/16-20	9/16-18	7/16-20
04-06-06	7/16-20	9/16-18	9/16-18
05-05-05	1/2-20	1/2-20	1/2-20
06-04-06	9/16-18	7/16-20	9/16-18
06-06-06	9/16-18	9/16-18	9/16-18
06-06-08	9/16-18	9/16-18	3/4-16
06-08-06	9/16-18	3/4-16	9/16-18
08-06-08	3/4-16	9/16-18	3/4-16
08-08-04	3/4-16	3/4-16	7/16-20
08-08-08	3/4-16	3/4-16	3/4-16
08-10-08	3/4-16	7/8-14	3/4-16
08-12-08	3/4-16	1 1/16-12	3/4-16
10-08-08	7/8-14	3/4-16	3/4-16
10-10-10	7/8-14	7/8-14	7/8-14
10-12-10	7/8-14	1 1/16-12	7/8-14
12-10-12	1 1/16-12	7/8-14	1 1/16-12
12-12-04	1 1/16-12	1 1/16-12	7/16-20
12-12-08	1 1/16-12	1 1/16-12	3/4-16
12-12-12	1 1/16-12	1 1/16-12	1 1/16-12
12-12-16	1 1/16-12	1 1/16-12	1 5/16-12
12-16-12	1 1/16-12	1 5/16-12	1 1/16-12
14-14-14	1 3/16-12	1 3/16-12	1 3/16-12
16-12-16	1 5/16-12	1 1/16-12	1 5/16-12
16-16-16	1 5/16-12	1 5/16-12	1 5/16-12
20-20-20	1 5/8-12	1 5/8-12	1 5/8-12
24-24-24	1 7/8-12	1 7/8-12	1 7/8-12
32-32-32	2 1/2-12	2 1/2-12	2 1/2-12

AVAILABILITY

- » Import Steel
- » Steel
- » Import Stainless Steel
- » Stainless Steel

COMPLIANCE

- » MS 51530
- » SAE 070428

6809

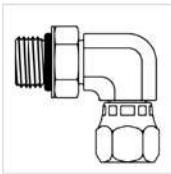

O-Ring to JIC Swivel Elbow 90°

SHAPE

90 degree elbow

Dash Size	Male O-Ring	Female JIC Swivel
04-04	7/16-20	7/16-20
06-04	9/16-18	7/16-20
06-06	9/16-18	9/16-18
08-06	3/4-16	9/16-18
08-08	3/4-16	3/4-16
08-10	3/4-16	7/8-14
10-08	7/8-14	3/4-16
10-10	7/8-14	7/8-14
12-08	1 1/16-12	3/4-16
12-12	1 1/16-12	1 1/16-12
16-16	1 5/16-12	1 5/16-12
20-20	1 5/8-12	1 5/8-12
24-24	1 7/8-12	1 7/8-12

AVAILABILITY

- » Import Steel
- » Steel

MJ to FJX 90° Bent Tube

SHAPE

90 degree elbow

Dash Size	Male JIC	Female JIC Swivel
04-04	7/16-20	7/16-20
06-06	9/16-18	9/16-18
08-08	3/4-16	3/4-16
10-10	7/8-14	7/8-14
12-12	1 1/16-12	1 1/16-12
16-16	1 5/16-12	1 5/16-12
20-20	1 5/8-12	1 5/8-12
24-24	1 7/8-12	1 7/8-12

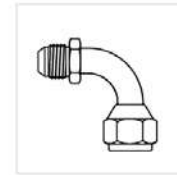

NB6701

AVAILABILITY

» Import Steel

MJ to FJX 90° Long Bent Tube

SHAPE

90 degree elbow

Dash Size	Male JIC	Female JIC Swivel
04-04	7/16-20	7/16-20
06-06	9/16-18	9/16-18
08-08	3/4-16	3/4-16
10-10	7/8-14	7/8-14
12-12	1 1/16-12	1 1/16-12
16-16	1 5/16-12	1 5/16-12
20-20	1 5/8-12	1 5/8-12

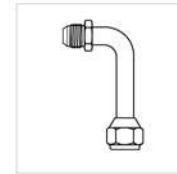

NB6701-L

AVAILABILITY

» Import Steel

MJ to FJX 45° Bent Tube

SHAPE

45 degree elbow

Dash Size	Male JIC	Female JIC Swivel
04-04	7/16-20	7/16-20
06-06	9/16-18	9/16-18
08-08	3/4-16	3/4-16
10-10	7/8-14	7/8-14
12-12	1 1/16-12	1 1/16-12
16-16	1 5/16-12	1 5/16-12



NB6702

AVAILABILITY

» Import Steel

SAE O-Ring Adapters

6403



O-Ring Union

SHAPE

Straight

Dash Size	Male O-Ring	Male O-Ring
04-04	7/16-20	7/16-20
06-04	9/16-18	7/16-20
06-06	9/16-18	9/16-18
08-08	3/4-16	3/4-16
10-08	7/8-14	3/4-16
10-10	7/8-14	7/8-14
12-08	1 1/16-12	3/4-16
12-10	1 1/16-12	7/8-14
12-12	1 1/16-12	1 1/16-12
16-12	1 5/16-12	1 1/16-12
16-16	1 5/16-12	1 5/16-12
20-16	1 5/8-12	1 5/16-12
20-20	1 5/8-12	1 5/8-12
24-20	1 7/8-12	1 5/8-12
24-24	1 7/8-12	1 7/8-12
32-32	2 1/2-12	2 1/2-12

AVAILABILITY

- » Import Steel
- » Steel

6403-NWO



O-Ring Adjustable Union

SHAPE

Straight

Dash Size	Male O-Ring	Male O-Ring
03-03	3/8-24	3/8-24
04-04	7/16-20	7/16-20
06-06	9/16-18	9/16-18
08-06	3/4-16	9/16-18
08-08	3/4-16	3/4-16
10-08	7/8-14	3/4-16
10-10	7/8-14	7/8-14
12-08	1 1/16-12	3/4-16
12-10	1 1/16-12	7/8-14
12-12	1 1/16-12	1 1/16-12
16-12	1 5/16-12	1 1/16-12
16-16	1 5/16-12	1 5/16-12
20-20	1 5/8-12	1 5/8-12
24-24	1 7/8-12	1 7/8-12
32-32	2 1/2-12	2 1/2-12

AVAILABILITY

- » Import Steel
- » Steel
- » Import Stainless Steel
- » Stainless Steel

O-Ring Hex Plug

SHAPE

Plug

Dash Size	Male O-Ring
02	5/16-24
03	3/8-24
04	7/16-20
05	1/2-20
06	9/16-18
08	3/4-16
10	7/8-14
12	1 1/16-12
14	1 3/16-12
16	1 5/16-12
20	1 5/8-12
24	1 7/8-12
32	2 1/2-12

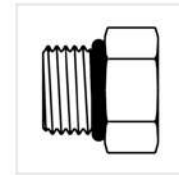

6408

COMPLIANCE

» SAE 090109A

AVAILABILITY

- » Import Steel
- » Steel
- » Import Stainless Steel
- » Stainless Steel

O-Ring Hollow Hex Plug

SHAPE

Plug

Dash Size	Male O-Ring
02	5/16-24
03	3/8-24
04	7/16-20
05	1/2-20
06	9/16-18
08	3/4-16
10	7/8-14
12	1 1/16-12
14	1 3/16-12
16	1 5/16-12
20	1 5/8-12
24	1 7/8-12
32	2 1/2-12

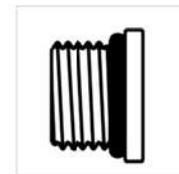

6408-HHP

COMPLIANCE

» SAE 090109B

AVAILABILITY

- » Import Steel
- » Steel
- » Import Stainless Steel
- » Stainless Steel

6410

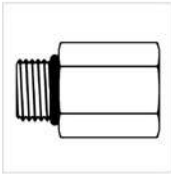

O-Ring to O-Ring Reducer/Expander/Extender

SHAPE

Straight

Dash Size	Male O-Ring	Female O-Ring
02-04	5/16-24	7/16-20
04-04	7/16-20	7/16-20
04-05	7/16-20	1/2-20
04-06	7/16-20	9/16-18
04-08	7/16-20	3/4-16
05-03	1/2-20	3/8-24
05-04	1/2-20	7/16-20
05-06	1/2-20	9/16-18
06-04	9/16-18	7/16-20
06-06	9/16-18	9/16-18
06-08	9/16-18	3/4-16
08-04	3/4-16	7/16-20
08-05	3/4-16	1/2-20
08-06	3/4-16	9/16-18
08-08	3/4-16	3/4-16
08-10	3/4-16	7/8-14
08-12	3/4-16	1 1/16-12
10-04	7/8-14	7/16-20
10-05	7/8-14	1/2-20
10-06	7/8-14	9/16-18
10-08	7/8-14	3/4-16
10-12	7/8-14	1 1/16-12
12-04	1 1/16-12	7/16-20
12-06	1 1/16-12	9/16-18
12-08	1 1/16-12	3/4-16
12-10	1 1/16-12	7/8-14
12-12	1 1/16-12	1 1/16-12
12-14	1 1/16-12	1 3/16-12
12-16	1 1/16-12	1 5/16-12
12-20	1 1/16-12	1 5/8-12
14-08	1 3/16-12	3/4-16
14-10	1 3/16-12	7/8-14
14-12	1 3/16-12	1 1/16-12
16-04	1 5/16-12	7/16-20
16-06	1 5/16-12	9/16-18
16-08	1 5/16-12	3/4-16
16-10	1 5/16-12	7/8-14
16-12	1 5/16-12	1 1/16-12
16-14	1 5/16-12	1 3/16-12
16-16	1 5/16-12	1 5/16-12
16-20	1 5/16-12	1 5/8-12
20-04	1 5/8-12	7/16-20
20-06	1 5/8-12	9/16-18
20-08	1 5/8-12	3/4-16
20-10	1 5/8-12	7/8-14
20-12	1 5/8-12	1 1/16-12
20-16	1 5/8-12	1 5/16-12
20-24	1 5/8-12	1 7/8-12
24-12	1 7/8-12	1 1/16-12
24-16	1 7/8-12	1 5/16-12
24-20	1 7/8-12	1 5/8-12

AVAILABILITY

- » Import Steel
- » Steel
- » Import Stainless Steel
- » Stainless Steel

Dash Size	Male O-Ring	Female O-Ring
32-12	2 1/2-12	1 1/16-12
32-16	2 1/2-12	1 5/16-12
32-20	2 1/2-12	1 5/8-12
32-24	2 1/2-12	1 7/8-12

6410
▼ continued

O-Ring to O-Ring Extender

SHAPE

Straight

Dash Size	Male O-Ring	Female O-Ring	Overall Adapter Length (OAL)
04-04	7/16-20	7/16-20	1.25
06-06	9/16-18	9/16-18	1.50
08-08	3/4-16	3/4-16	1.75
10-10	7/8-14	7/8-14	2.00
10-10	7/8-14	7/8-14	2.38
12-12	1 1/16-12	1 1/16-12	2.38

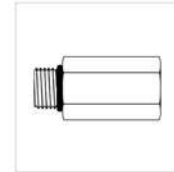

6410-L

AVAILABILITY

- » Import Steel
- » Steel

O-Ring to O-Ring Coupling

SHAPE

Straight

Dash Size	Female O-Ring	Female O-Ring
04-04	7/16-20	7/16-20
06-06	9/16-18	9/16-18
08-08	3/4-16	3/4-16
10-10	7/8-14	7/8-14
12-12	1 1/16-12	1 1/16-12
20-20	1 5/8-12	1 5/8-12
24-24	1 7/8-12	1 7/8-12

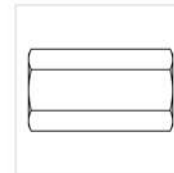

6425

AVAILABILITY

- » Import Steel
- » Steel

O-Ring Adjustable Union Elbow 90°

SHAPE

90 degree elbow

Dash Size	Male O-Ring	Male O-Ring
04-04	7/16-20	7/16-20
06-04	9/16-18	7/16-20
06-06	9/16-18	9/16-18
08-06	3/4-16	9/16-18
08-08	3/4-16	3/4-16
10-08	7/8-14	3/4-16
10-10	7/8-14	7/8-14
12-12	1 1/16-12	1 1/16-12
16-16	1 5/16-12	1 5/16-12
20-20	1 5/8-12	1 5/8-12
24-24	1 7/8-12	1 7/8-12
32-32	2 1/2-12	2 1/2-12

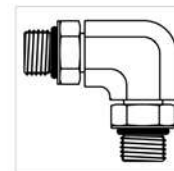

6807

AVAILABILITY

- » Import Steel
- » Steel

6815

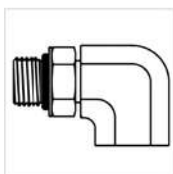

O-Ring Adjustable Street Elbow 90°

SHAPE

90 degree elbow

Dash Size	Male O-Ring	Female O-Ring
04-04	7/16-20	7/16-20
04-06	7/16-20	9/16-18
06-04	9/16-18	7/16-20
06-06	9/16-18	9/16-18
06-08	9/16-18	3/4-16
08-06	3/4-16	9/16-18
08-08	3/4-16	3/4-16
10-10	7/8-14	7/8-14
12-10	1 1/16-12	7/8-14
12-12	1 1/16-12	1 1/16-12
16-16	1 5/16-12	1 5/16-12
20-20	1 5/8-12	1 5/8-12

AVAILABILITY

- » Import Steel
- » Steel

6832

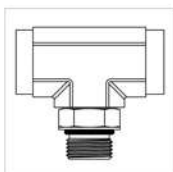

O-Ring Branch Tee

SHAPE

Tee

Dash Size	Female O-Ring	Female O-Ring	Male O-Ring
06-06-06	9/16-18	9/16-18	9/16-18
08-08-08	3/4-16	3/4-16	3/4-16
16-16-16	1 5/16-12	1 5/16-12	1 5/16-12

AVAILABILITY

- » Import Steel

6835

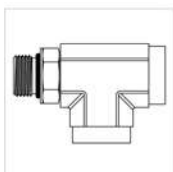

O-Ring to O-Ring Run Tee

SHAPE

Tee

Dash Size	Male O-Ring	Female O-Ring	Female O-Ring
04-04-04	7/16-20	7/16-20	7/16-20
06-06-06	9/16-18	9/16-18	9/16-18
08-08-08	3/4-16	3/4-16	3/4-16
10-10-10	7/8-14	7/8-14	7/8-14
12-12-12	1 1/16-12	1 1/16-12	1 1/16-12

AVAILABILITY

- » Import Steel

Viton 75 Durometer SAE Boss O-Ring

Please note: Viton is a registered trademark of DuPont Dow Elastomers. Visit their site for more information.

SHAPE

O-Ring

Dash Size
02
03
04
05
06
08
10
12
14
16
20
24
32



AVAILABILITY

» Viton 75 Durometer

Buna-Nitrile 90 Durometer SAE Boss O-Ring

SHAPE

O-Ring

Dash Size
02
03
04
05
06
08
10
12
14
16
20
24
32

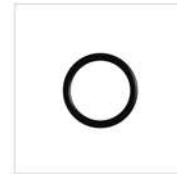

AVAILABILITY

» Buna-Nitrile 90 Durometer

Pipe Adapters

2708

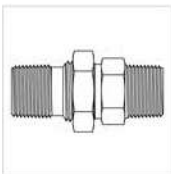

Pipe Bulkhead

To include locknut with bulkhead fitting, insert "LN" between base part number and dash size.

(Example: 2708-LN-04-04)

SHAPE

Straight

Dash Size	Male Pipe	Male Pipe
04-04	1/4-18	1/4-18
06-06	3/8-18	3/8-18
08-08	1/2-14	1/2-14
12-12	3/4-14	3/4-14
16-16	1-11 1/2	1-11 1/2

AVAILABILITY

» Steel

404

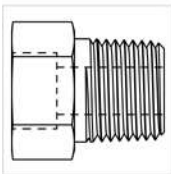

Braze Port to Pipe

Use with silver braze ring. Order SBR and size (e.g. SBR04).

SHAPE

Straight

Dash Size	Braze Port	Male Pipe
06-04	3/8	1/4-18
08-06	1/2	3/8-18
08-08	1/2	1/2-14
10-08	5/8	1/2-14
12-08	3/4	1/2-14
12-12	3/4	3/4-14
16-16	1	1-11 1/2
20-16	1 1/4	1-11 1/2
20-20	1 1/4	1 1/4-11 1/2
24-24	1 1/2	1 1/2-11 1/2

AVAILABILITY

» Steel

5000

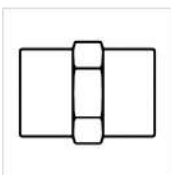

Pipe Coupling

SHAPE

Straight

Dash Size	Female Pipe	Female Pipe
02-02	1/8-27	1/8-27
04-02	1/4-18	1/8-27
04-04	1/4-18	1/4-18
06-02	3/8-18	1/8-27
06-04	3/8-18	1/4-18
06-06	3/8-18	3/8-18
08-02	1/2-14	1/8-27
08-04	1/2-14	1/4-18
08-06	1/2-14	3/8-18
08-08	1/2-14	1/2-14
12-04	3/4-14	1/4-18
12-06	3/4-14	3/8-18
12-08	3/4-14	1/2-14
12-12	3/4-14	3/4-14
16-08	1-11 1/2	1/2-14
16-12	1-11 1/2	3/4-14

AVAILABILITY

» Import Steel

» Steel

» Import Stainless Steel

» Stainless Steel

COMPLIANCE

» SAE 140138

Dash Size	Female Pipe	Female Pipe
16-16	1-11 1/2	1-11 1/2
20-12	1 1/4-11 1/2	3/4-14
20-16	1 1/4-11 1/2	1-11 1/2
20-20	1 1/4-11 1/2	1 1/4-11 1/2
24-20	1 1/2-11 1/2	1 1/4-11 1/2
24-24	1 1/2-11 1/2	1 1/2-11 1/2
32-32	2-11 1/2	2-11 1/2

5000
▼ continued

Close Pipe Nipple GALVANIZED

Schedule 80 Galvanized Steel.

SHAPE

Straight



5400-CL

Dash Size	Male Pipe	Male Pipe	Overall Adapter Length (OAL)
02-02	1/8-27	1/8-27	0.75
04-04	1/4-18	1/4-18	0.75
04-04	1/4-18	1/4-18	0.875
06-06	3/8-18	3/8-18	1.00
08-08	1/2-14	1/2-14	1.00
08-08	1/2-14	1/2-14	1.125
12-12	3/4-14	3/4-14	1.375
16-16	1-11 1/2	1-11 1/2	1.50
20-20	1 1/4-11 1/2	1 1/4-11 1/2	1.625
24-24	1 1/2-11 1/2	1 1/2-11 1/2	1.75
32-32	2-11 1/2	2-11 1/2	2.00

COMPLIANCE

» 3000 psi

AVAILABILITY

» Steel
» Stainless Steel

Long Pipe Nipple

Black Extra Heavy Schedule 80 Seamless

SHAPE

Straight

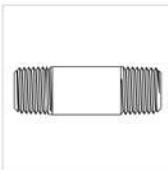

5400-N

Dash Size	Male Pipe	Male Pipe	Overall Adapter Length (OAL)
02-02	1/8-27	1/8-27	1.50
02-02	1/8-27	1/8-27	2.00
02-02	1/8-27	1/8-27	2.50
02-02	1/8-27	1/8-27	3.00
02-02	1/8-27	1/8-27	3.50
02-02	1/8-27	1/8-27	4.00
02-02	1/8-27	1/8-27	5.00
02-02	1/8-27	1/8-27	6.00
02-02	1/8-27	1/8-27	9.00
04-04	1/4-18	1/4-18	1.50
04-04	1/4-18	1/4-18	2.00
04-04	1/4-18	1/4-18	2.50
04-04	1/4-18	1/4-18	3.00
04-04	1/4-18	1/4-18	3.50
04-04	1/4-18	1/4-18	4.00
04-04	1/4-18	1/4-18	5.00
04-04	1/4-18	1/4-18	6.00
06-06	3/8-18	3/8-18	2.00
06-06	3/8-18	3/8-18	2.50
06-06	3/8-18	3/8-18	3.00
06-06	3/8-18	3/8-18	3.50

COMPLIANCE

» 3000 psi

AVAILABILITY

» Steel
» Stainless Steel

▼ 5400-N continues

5400-N
 ▼ continued

Dash Size	Male Pipe	Male Pipe	Overall Adapter Length (OAL)
06-06	3/8-18	3/8-18	4.00
06-06	3/8-18	3/8-18	4.50
06-06	3/8-18	3/8-18	5.00
06-06	3/8-18	3/8-18	5.50
06-06	3/8-18	3/8-18	6.00
06-06	3/8-18	3/8-18	7.00
06-06	3/8-18	3/8-18	8.00
08-08	1/2-14	1/2-14	2.00
08-08	1/2-14	1/2-14	2.50
08-08	1/2-14	1/2-14	3.00
08-08	1/2-14	1/2-14	4.00
08-08	1/2-14	1/2-14	4.50
08-08	1/2-14	1/2-14	5.00
08-08	1/2-14	1/2-14	6.00
08-08	1/2-14	1/2-14	8.00
08-08	1/2-14	1/2-14	12.00
12-12	3/4-14	3/4-14	2.00
12-12	3/4-14	3/4-14	2.50
12-12	3/4-14	3/4-14	3.00
12-12	3/4-14	3/4-14	3.50
12-12	3/4-14	3/4-14	4.00
12-12	3/4-14	3/4-14	5.00
12-12	3/4-14	3/4-14	5.50
12-12	3/4-14	3/4-14	6.00
12-12	3/4-14	3/4-14	7.00
12-12	3/4-14	3/4-14	10.00
12-12	3/4-14	3/4-14	12.00
16-16	1-11 1/2	1-11 1/2	3.00
16-16	1-11 1/2	1-11 1/2	4.00
16-16	1-11 1/2	1-11 1/2	5.00
16-16	1-11 1/2	1-11 1/2	5.50
16-16	1-11 1/2	1-11 1/2	6.00
16-16	1-11 1/2	1-11 1/2	8.00
20-20	1 1/4-11 1/2	1 1/4-11 1/2	2.50
20-20	1 1/4-11 1/2	1 1/4-11 1/2	3.00
20-20	1 1/4-11 1/2	1 1/4-11 1/2	3.50
20-20	1 1/4-11 1/2	1 1/4-11 1/2	4.00
20-20	1 1/4-11 1/2	1 1/4-11 1/2	5.00
20-20	1 1/4-11 1/2	1 1/4-11 1/2	6.00
20-20	1 1/4-11 1/2	1 1/4-11 1/2	9.00
24-24	1 1/2-11 1/2	1 1/2-11 1/2	4.00
24-24	1 1/2-11 1/2	1 1/2-11 1/2	6.00
32-32	2-11 1/2	2-11 1/2	2.50
32-32	2-11 1/2	2-11 1/2	4.00
32-32	2-11 1/2	2-11 1/2	5.00
32-32	2-11 1/2	2-11 1/2	6.00
32-32	2-11 1/2	2-11 1/2	7.50

Hex Pipe Nipple

SHAPE

Straight

Dash Size	Male Pipe	Male Pipe
02-01	1/8-27	1/16-27
02-02	1/8-27	1/8-27
04-02	1/4-18	1/8-27
04-04	1/4-18	1/4-18
06-02	3/8-18	1/8-27
06-04	3/8-18	1/4-18
06-06	3/8-18	3/8-18
08-02	1/2-14	1/8-27
08-04	1/2-14	1/4-18
08-06	1/2-14	3/8-18
08-08	1/2-14	1/2-14
12-04	3/4-14	1/4-18
12-06	3/4-14	3/8-18
12-08	3/4-14	1/2-14
12-12	3/4-14	3/4-14
16-04	1-11 1/2	1/4-18
16-06	1-11 1/2	3/8-18
16-08	1-11 1/2	1/2-14
16-12	1-11 1/2	3/4-14
16-16	1-11 1/2	1-11 1/2
20-08	1 1/4-11 1/2	1/2-14
20-12	1 1/4-11 1/2	3/4-14
20-16	1 1/4-11 1/2	1-11 1/2
20-20	1 1/4-11 1/2	1 1/4-11 1/2
24-12	1 1/2-11 1/2	3/4-14
24-16	1 1/2-11 1/2	1-11 1/2
24-20	1 1/2-11 1/2	1 1/4-11 1/2
24-24	1 1/2-11 1/2	1 1/2-11 1/2
32-20	2-11 1/2	1 1/4-11 1/2
32-24	2-11 1/2	1 1/2-11 1/2
32-32	2-11 1/2	2-11 1/2
40-40	2 1/2-8	2 1/2-8

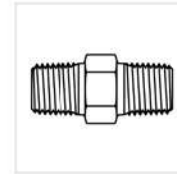

5404

COMPLIANCE
» SAE 140137

AVAILABILITY
» Import Steel
» Steel
» Import Stainless Steel
» Stainless Steel

Long Hex Pipe Nipple

SHAPE

Straight

Dash Size	Male Pipe	Male Pipe	Overall Adapter Length (OAL)
02-02	1/8-27	1/8-27	1.50
02-02	1/8-27	1/8-27	2.00
02-02	1/8-27	1/8-27	2.50
02-02	1/8-27	1/8-27	3.00
02-02	1/8-27	1/8-27	3.50
02-02	1/8-27	1/8-27	4.00
04-04	1/4-18	1/4-18	1.50
04-04	1/4-18	1/4-18	2.00
04-04	1/4-18	1/4-18	2.50
04-04	1/4-18	1/4-18	3.00
04-04	1/4-18	1/4-18	4.00
04-04	1/4-18	1/4-18	6.00
04-04	1/4-18	1/4-18	8.00

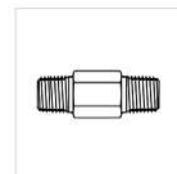

5404-L

AVAILABILITY
» Import Steel
» Steel
» Import Stainless Steel
» Stainless Steel

▼ 5404-L continues

5404-L
▼ continued

Dash Size	Male Pipe	Male Pipe	Overall Adapter Length (OAL)
06-06	3/8-18	3/8-18	2.00
06-06	3/8-18	3/8-18	2.50
06-06	3/8-18	3/8-18	3.00
06-06	3/8-18	3/8-18	3.50
06-06	3/8-18	3/8-18	4.00
06-06	3/8-18	3/8-18	6.00
06-06	3/8-18	3/8-18	7.00
08-08	1/2-14	1/2-14	2.00
08-08	1/2-14	1/2-14	2.50
08-08	1/2-14	1/2-14	3.00
08-08	1/2-14	1/2-14	3.50
08-08	1/2-14	1/2-14	4.00
08-08	1/2-14	1/2-14	6.00
12-12	3/4-14	3/4-14	3.00
12-12	3/4-14	3/4-14	3.50
12-12	3/4-14	3/4-14	4.00
12-12	3/4-14	3/4-14	6.00
16-16	1-11 1/2	1-11 1/2	3.00
16-16	1-11 1/2	1-11 1/2	4.00
16-16	1-11 1/2	1-11 1/2	4.50
16-16	1-11 1/2	1-11 1/2	6.00
20-20	1 1/4-11 1/2	1 1/4-11 1/2	4.00
20-20	1 1/4-11 1/2	1 1/4-11 1/2	6.00
24-24	1 1/2-11 1/2	1 1/2-11 1/2	4.00
24-24	1 1/2-11 1/2	1 1/2-11 1/2	6.00
32-32	2-11 1/2	2-11 1/2	4.00
32-32	2-11 1/2	2-11 1/2	6.00

5405

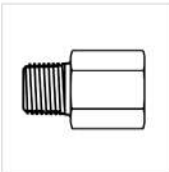

Pipe to Pipe Expander

SHAPE

Straight

Dash Size	Male Pipe	Female Pipe
01-02	1/16-27	1/8-27
02-02	1/8-27	1/8-27
02-04	1/8-27	1/4-18
02-06	1/8-27	3/8-18
02-08	1/8-27	1/2-14
04-04	1/4-18	1/4-18
04-06	1/4-18	3/8-18
04-08	1/4-18	1/2-14
04-12	1/4-18	3/4-14
04-16	1/4-18	1-11 1/2
04-20	1/4-18	1 1/4-11 1/2
04/28-02	1/4-28	1/8-27
06-06	3/8-18	3/8-18
06-08	3/8-18	1/2-14
06-12	3/8-18	3/4-14
08-06	1/2-14	3/8-18
08-08	1/2-14	1/2-14
08-12	1/2-14	3/4-14
08-16	1/2-14	1-11 1/2
12-08	3/4-14	1/2-14
12-12	3/4-14	3/4-14

AVAILABILITY

- » Import Steel
- » Steel
- » Import Stainless Steel
- » Stainless Steel

COMPLIANCE

- » SAE 140139

Dash Size	Male Pipe	Female Pipe
12-16	3/4-14	1-11 1/2
12-20	3/4-14	1 1/4-11 1/2
16-16	1-11 1/2	1-11 1/2
16-20	1-11 1/2	1 1/4-11 1/2
16-24	1-11 1/2	1 1/2-11 1/2
20-20	1 1/4-11 1/2	1 1/4-11 1/2
20-24	1 1/4-11 1/2	1 1/2-11 1/2
24-24	1 1/2-11 1/2	1 1/2-11 1/2
24-32	1 1/2-11 1/2	2-11 1/2
32-32	2-11 1/2	2-11 1/2

5405
▼ continued

Hex Pipe Reducer Bushing

SHAPE

Straight

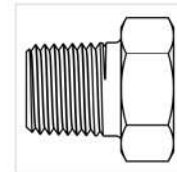

5406

Dash Size	Male Pipe	Female Pipe	Overall Adapter Length (OAL)	Length of Hex
02-01	1/8-27	1/16-27	0.68	.31
04-02	1/4-18	1/8-27	0.85	.28
06-02	3/8-18	1/8-27	0.85	.28
06-04	3/8-18	1/4-18	0.85	.28
08-02	1/2-14	1/8-27	1.10	.34
08-04	1/2-14	1/4-18	1.10	.34
08-06	1/2-14	3/8-18	1.10	.34
12-02	3/4-14	1/8-27	1.17	.40
12-04	3/4-14	1/4-18	1.17	.40
12-06	3/4-14	3/8-18	1.17	.40
12-08	3/4-14	1/2-14	1.17	.40
16-02	1-11 1/2	1/8-27	1.36	.41
16-04	1-11 1/2	1/4-18	1.36	.41
16-06	1-11 1/2	3/8-18	1.36	.41
16-08	1-11 1/2	1/2-14	1.36	.41
16-12	1-11 1/2	3/4-14	1.36	.41
20-04	1 1/4-11 1/2	1/4-18	1.47	.48
20-06	1 1/4-11 1/2	3/8-18	1.47	.48
20-08	1 1/4-11 1/2	1/2-14	1.47	.48
20-12	1 1/4-11 1/2	3/4-14	1.47	.48
20-16	1 1/4-11 1/2	1-11 1/2	1.47	.48
24-04	1 1/2-11 1/2	1/4-18	1.57	.58
24-06	1 1/2-11 1/2	3/8-18	1.57	.58
24-08	1 1/2-11 1/2	1/2-14	1.57	.58
24-12	1 1/2-11 1/2	3/4-14	1.57	.58
24-16	1 1/2-11 1/2	1-11 1/2	1.57	.58
24-20	1 1/2-11 1/2	1 1/4-11 1/2	1.57	.58
32-06	2-11 1/2	3/8-18	1.75	.67
32-08	2-11 1/2	1/2-14	1.75	.67
32-12	2-11 1/2	3/4-14	1.75	.67
32-16	2-11 1/2	1-11 1/2	1.75	.67
32-20	2-11 1/2	1 1/4-11 1/2	1.75	.67
32-24	2-11 1/2	1 1/2-11 1/2	0.63	1.75
32-24	2-11 1/2	1 1/2-11 1/2	1.75	.67
40-32	2 1/2-8	2-11 1/2	2.37	.97
48-24	3-8	1 1/2-11 1/2	2.83	1.27
48-32	3-8	2-11 1/2	2.83	1.27

COMPLIANCE

- » Hydraulic Pipe
- » SAE 1401 40

AVAILABILITY

- » Import Steel
- » Steel
- » Import Stainless Steel
- » Stainless Steel

5406-CAP

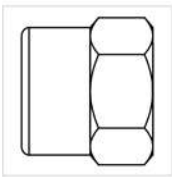

Pipe Cap

SHAPE

Cap

Dash Size	Female Pipe
02	1/8-27
04	1/4-18
06	3/8-18
08	1/2-14
12	3/4-14
16	1-11 1/2
20	1 1/4-11 1/2
24	1 1/2-11 1/2

AVAILABILITY

- » Import Steel
- » Steel
- » Import Stainless Steel
- » Stainless Steel

5406-E

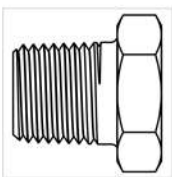

Short Hex Pipe Reducer Bushing

Automotive Pipe.

SHAPE

Straight

Dash Size	Male Pipe	Female Pipe	Overall Adapter Length (OAL)	Length of Hex
04-02	1/4-18	1/8-27	0.63	.15
06-02	3/8-18	1/8-27	0.66	.16
06-04	3/8-18	1/4-18	0.66	.16
08-02	1/2-14	1/8-27	0.70	.19
08-04	1/2-14	1/4-18	0.70	.19
08-06	1/2-14	3/8-18	0.70	.19
12-02	3/4-14	1/8-27	0.94	.22
12-04	3/4-14	1/4-18	0.94	.22
12-06	3/4-14	3/8-18	0.94	.22
12-08	3/4-14	1/2-14	0.94	.22
16-02	1-11 1/2	1/8-27	1.00	.25
16-04	1-11 1/2	1/4-18	1.00	.25
16-06	1-11 1/2	3/8-18	1.00	.25
16-08	1-11 1/2	1/2-14	1.00	.25
16-12	1-11 1/2	3/4-14	1.00	.25
20-02	1 1/4-11 1/2	1/8-27	1.17	.28
20-04	1 1/4-11 1/2	1/4-18	1.17	.28
20-06	1 1/4-11 1/2	3/8-18	1.17	.28
20-08	1 1/4-11 1/2	1/2-14	1.17	.28
20-12	1 1/4-11 1/2	3/4-14	1.17	.28
20-16	1 1/4-11 1/2	1-11 1/2	1.17	.28

AVAILABILITY

- » Steel

COMPLIANCE

- » Automotive Pipe

5406-FLP

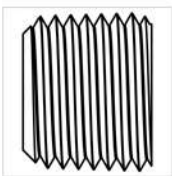

Flush Hollow Hex Pipe Plug 7/8 Taper

SHAPE

Plug

Dash Size	Male Pipe
01	1/16-27
02	1/8-27
04	1/4-18
06	3/8-18
08	1/2-14
12	3/4-14
16	1-11 1/2
20	1 1/4-11 1/2

AVAILABILITY

- » Steel

Hollow Hex Pipe Plug

Also available in aluminum (-AL) and magnetic (-MAG) styles. Call for availability.

SHAPE

Plug

Dash Size	Male Pipe
01	1/16-27
02	1/8-27
04	1/4-18
06	3/8-18
08	1/2-14
12	3/4-14
16	1-11 1/2
20	1 1/4-11 1/2
24	1 1/2-11 1/2
32	2-11 1/2

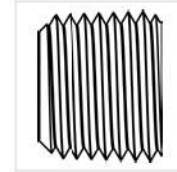

5406-HHP

COMPLIANCE
» SAE 130109

AVAILABILITY
» Import Steel
» Steel
» Import Stainless Steel
» Stainless Steel

Hex Head Pipe Plug

SHAPE

Plug

Dash Size	Male Pipe
01	1/16-27
02	1/8-27
04	1/4-18
06	3/8-18
08	1/2-14
12	3/4-14
16	1-11 1/2
20	1 1/4-11 1/2
24	1 1/2-11 1/2
32	2-11 1/2
40	2 1/2-8

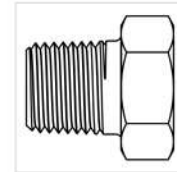

5406-P

COMPLIANCE
» SAE 130109E

AVAILABILITY
» Import Steel
» Steel
» Import Stainless Steel
» Stainless Steel

Square Head Pipe Plug

SHAPE

Plug

Dash Size	Male Pipe
01	1/16-27
02	1/8-27
04	1/4-18
06	3/8-18
08	1/2-14
12	3/4-14
16	1-11 1/2
20	1 1/4-11 1/2
24	1 1/2-11 1/2
32	2-11 1/2

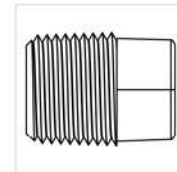

5406-SHP

COMPLIANCE
» SAE 130109A

AVAILABILITY
» Steel
» Stainless Steel

5500

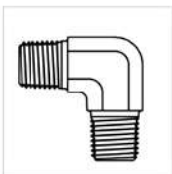

Pipe Elbow 90°

SHAPE

90 degree elbow

Dash Size	Male Pipe	Male Pipe
02-02	1/8-27	1/8-27
04-02	1/4-18	1/8-27
04-04	1/4-18	1/4-18
06-02	3/8-18	1/8-27
06-04	3/8-18	1/4-18
06-06	3/8-18	3/8-18
08-04	1/2-14	1/4-18
08-06	1/2-14	3/8-18
08-08	1/2-14	1/2-14
12-06	3/4-14	3/8-18
12-08	3/4-14	1/2-14
12-12	3/4-14	3/4-14
16-08	1-11 1/2	1/2-14
16-12	1-11 1/2	3/4-14
16-16	1-11 1/2	1-11 1/2
20-16	1 1/4-11 1/2	1-11 1/2
20-20	1 1/4-11 1/2	1 1/4-11 1/2
24-24	1 1/2-11 1/2	1 1/2-11 1/2
32-32	2-11 1/2	2-11 1/2

AVAILABILITY

- » Import Steel
- » Steel
- » Import Stainless Steel
- » Stainless Steel

COMPLIANCE

- » SAE 140237

5500-S



Pipe Swivel Elbow 90°

Swivel for installation only. May leak at low or residual system pressure. Not intended for use exceeding 212 degrees F.

SHAPE

90 degree elbow

Dash Size	Male Pipe	Male Pipe Swivel
04-04	1/4-18	1/4-18
06-06	3/8-18	3/8-18
08-08	1/2-14	1/2-14
12-12	3/4-14	3/4-14

AVAILABILITY

- » Import Steel
- » Steel

5501

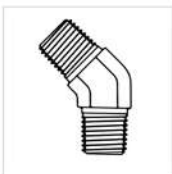

Pipe Elbow 45°

SHAPE

45 degree elbow

Dash Size	Male Pipe	Male Pipe
02-02	1/8-27	1/8-27
04-04	1/4-18	1/4-18
06-06	3/8-18	3/8-18
08-08	1/2-14	1/2-14
12-12	3/4-14	3/4-14
16-16	1-11 1/2	1-11 1/2
20-20	1 1/4-11 1/2	1 1/4-11 1/2
24-24	1 1/2-11 1/2	1 1/2-11 1/2

AVAILABILITY

- » Import Steel
- » Steel
- » Stainless Steel

Street Elbow 90°

SHAPE

90 degree elbow

Dash Size	Male Pipe	Female Pipe
02-02	1/8-27	1/8-27
02-04	1/8-27	1/4-18
04-02	1/4-18	1/8-27
04-04	1/4-18	1/4-18
04-06	1/4-18	3/8-18
04-08	1/4-18	1/2-14
04/28-02	1/4-28	1/8-27
06-02	3/8-18	1/8-27
06-04	3/8-18	1/4-18
06-06	3/8-18	3/8-18
06-08	3/8-18	1/2-14
08-04	1/2-14	1/4-18
08-06	1/2-14	3/8-18
08-08	1/2-14	1/2-14
08-12	1/2-14	3/4-14
12-08	3/4-14	1/2-14
12-12	3/4-14	3/4-14
12-16	3/4-14	1-11 1/2
16-08	1-11 1/2	1/2-14
16-12	1-11 1/2	3/4-14
16-16	1-11 1/2	1-11 1/2
16-20	1-11 1/2	1 1/4-11 1/2
20-16	1 1/4-11 1/2	1-11 1/2
20-20	1 1/4-11 1/2	1 1/4-11 1/2
20-24	1 1/4-11 1/2	1 1/2-11 1/2
24-20	1 1/2-11 1/2	1 1/4-11 1/2
24-24	1 1/2-11 1/2	1 1/2-11 1/2
32-32	2-11 1/2	2-11 1/2

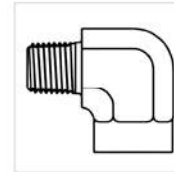

5502

COMPLIANCE

» SAE 140239

AVAILABILITY

- » Import Steel
- » Steel
- » Import Stainless Steel
- » Stainless Steel

Street Elbow Pipe Swivel 90°

Swivel for installation only. May leak at low or residual system pressure. Not intended for use exceeding 212 degrees F.

SHAPE

90 degree elbow

Dash Size	Male Pipe Swivel	Female Pipe
04-04	1/4-18	1/4-18
06-06	3/8-18	3/8-18
08-08	1/2-14	1/2-14
12-12	3/4-14	3/4-14

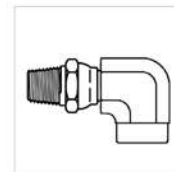

5502-S

AVAILABILITY

- » Import Steel
- » Steel

Short Body Street Pipe Elbow 90°

SHAPE

90 degree elbow

Dash Size	Male Pipe	Female Pipe
02-02	1/8-27	1/8-27
04-04	1/4-18	1/4-18
06-06	3/8-18	3/8-18
08-08	1/2-14	1/2-14

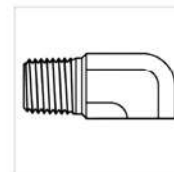

5502-X

AVAILABILITY

- » Import Steel
- » Steel

5503



Street Pipe Elbow 45°

SHAPE

45 degree elbow

Dash Size	Male Pipe	Female Pipe
02-02	1/8-27	1/8-27
04-04	1/4-18	1/4-18
04/28-02	1/4-28	1/8-27
06-06	3/8-18	3/8-18
08-08	1/2-14	1/2-14
12-12	3/4-14	3/4-14
16-16	1-11 1/2	1-11 1/2
20-20	1 1/4-11 1/2	1 1/4-11 1/2
24-24	1 1/2-11 1/2	1 1/2-11 1/2
32-32	2-11 1/2	2-11 1/2

AVAILABILITY

- » Import Steel
- » Steel
- » Import Stainless Steel
- » Stainless Steel

COMPLIANCE

- » SAE 140339

5504

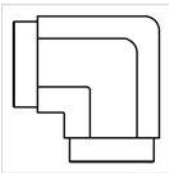

Pipe Elbow 90°

SHAPE

90 degree elbow

Dash Size	Female Pipe	Female Pipe
02-02	1/8-27	1/8-27
04-02	1/4-18	1/8-27
04-04	1/4-18	1/4-18
06-04	3/8-18	1/4-18
06-06	3/8-18	3/8-18
08-04	1/2-14	1/4-18
08-06	1/2-14	3/8-18
08-08	1/2-14	1/2-14
12-08	3/4-14	1/2-14
12-12	3/4-14	3/4-14
16-12	1-11 1/2	3/4-14
16-16	1-11 1/2	1-11 1/2
20-20	1 1/4-11 1/2	1 1/4-11 1/2
24-24	1 1/2-11 1/2	1 1/2-11 1/2
32-32	2-11 1/2	2-11 1/2

AVAILABILITY

- » Import Steel
- » Steel
- » Import Stainless Steel
- » Stainless Steel

COMPLIANCE

- » SAE 140238

5505

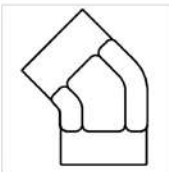

Pipe Elbow 45°

SHAPE

45 degree elbow

Dash Size	Female Pipe	Female Pipe
02-02	1/8-27	1/8-27
04-04	1/4-18	1/4-18
06-06	3/8-18	3/8-18
08-08	1/2-14	1/2-14
12-12	3/4-14	3/4-14
16-16	1-11 1/2	1-11 1/2
20-20	1 1/4-11 1/2	1 1/4-11 1/2
24-24	1 1/2-11 1/2	1 1/2-11 1/2
32-32	2-11 1/2	2-11 1/2

AVAILABILITY

- » Import Steel
- » Steel
- » Stainless Steel

COMPLIANCE

- » SAE 140338

Pipe Tee

SHAPE

Tee

Dash Size	Male Pipe	Male Pipe	Male Pipe
02-02-02	1/8-27	1/8-27	1/8-27
04-04-04	1/4-18	1/4-18	1/4-18
06-06-06	3/8-18	3/8-18	3/8-18
08-08-08	1/2-14	1/2-14	1/2-14
12-12-12	3/4-14	3/4-14	3/4-14
16-16-16	1-11 1/2	1-11 1/2	1-11 1/2
20-20-20	1 1/4-11 1/2	1 1/4-11 1/2	1 1/4-11 1/2
24-24-24	1 1/2-11 1/2	1 1/2-11 1/2	1 1/2-11 1/2

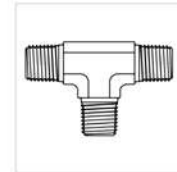

5600

COMPLIANCE
» SAE 140437

AVAILABILITY
» Import Steel
» Steel
» Import Stainless Steel
» Stainless Steel

Pipe Tee

SHAPE

Tee

Dash Size	Male Pipe	Male Pipe	Female Pipe
02-02-02	1/8-27	1/8-27	1/8-27
04-04-04	1/4-18	1/4-18	1/4-18
06-06-06	3/8-18	3/8-18	3/8-18
08-08-08	1/2-14	1/2-14	1/2-14
12-12-12	3/4-14	3/4-14	3/4-14
16-16-16	1-11 1/2	1-11 1/2	1-11 1/2
20-20-20	1 1/4-11 1/2	1 1/4-11 1/2	1 1/4-11 1/2
24-24-24	1 1/2-11 1/2	1 1/2-11 1/2	1 1/2-11 1/2

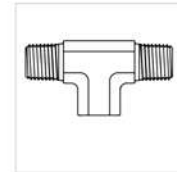

5601

COMPLIANCE
» SAE 140427

AVAILABILITY
» Import Steel
» Steel
» Import Stainless Steel
» Stainless Steel

Street Pipe Tee

SHAPE

Tee

Dash Size	Male Pipe	Female Pipe	Female Pipe
02-02-02	1/8-27	1/8-27	1/8-27
02-04-04	1/8-27	1/4-18	1/4-18
04-04-04	1/4-18	1/4-18	1/4-18
06-06-06	3/8-18	3/8-18	3/8-18
08-08-08	1/2-14	1/2-14	1/2-14
12-12-12	3/4-14	3/4-14	3/4-14
16-16-16	1-11 1/2	1-11 1/2	1-11 1/2
20-20-20	1 1/4-11 1/2	1 1/4-11 1/2	1 1/4-11 1/2
24-24-24	1 1/2-11 1/2	1 1/2-11 1/2	1 1/2-11 1/2
32-32-32	2-11 1/2	2-11 1/2	2-11 1/2

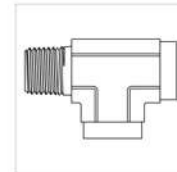

5602

COMPLIANCE
» SAE 140424

AVAILABILITY
» Import Steel
» Steel
» Import Stainless Steel
» Stainless Steel

5603

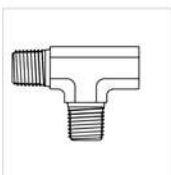

Pipe Tee

SHAPE

Tee

Dash Size	Male Pipe	Female Pipe	Male Pipe
02-02-02	1/8-27	1/8-27	1/8-27
04-04-04	1/4-18	1/4-18	1/4-18
06-06-06	3/8-18	3/8-18	3/8-18
08-08-08	1/2-14	1/2-14	1/2-14
12-12-12	3/4-14	3/4-14	3/4-14
16-16-16	1-11 1/2	1-11 1/2	1-11 1/2
20-20-20	1 1/4-11 1/2	1 1/4-11 1/2	1 1/4-11 1/2
24-24-24	1 1/2-11 1/2	1 1/2-11 1/2	1 1/2-11 1/2
32-32-32	2-11 1/2	2-11 1/2	2-11 1/2

AVAILABILITY

- » Import Steel
- » Steel
- » Import Stainless Steel
- » Stainless Steel

COMPLIANCE

- » SAE 140426

5604



Branch Pipe Tee

SHAPE

Tee

Dash Size	Female Pipe	Female Pipe	Male Pipe
02-02-02	1/8-27	1/8-27	1/8-27
04-04-04	1/4-18	1/4-18	1/4-18
06-06-06	3/8-18	3/8-18	3/8-18
08-08-08	1/2-14	1/2-14	1/2-14
12-12-12	3/4-14	3/4-14	3/4-14
16-16-16	1-11 1/2	1-11 1/2	1-11 1/2
20-20-20	1 1/4-11 1/2	1 1/4-11 1/2	1 1/4-11 1/2
24-24-24	1 1/2-11 1/2	1 1/2-11 1/2	1 1/2-11 1/2
32-32-32	2-11 1/2	2-11 1/2	2-11 1/2

AVAILABILITY

- » Import Steel
- » Steel
- » Import Stainless Steel
- » Stainless Steel

COMPLIANCE

- » SAE 140425

5605

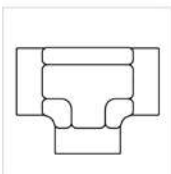

Pipe Tee

SHAPE

Tee

Dash Size	Female Pipe	Female Pipe	Female Pipe
02-02-02	1/8-27	1/8-27	1/8-27
04-04-04	1/4-18	1/4-18	1/4-18
06-06-06	3/8-18	3/8-18	3/8-18
08-08-08	1/2-14	1/2-14	1/2-14
12-12-08	3/4-14	3/4-14	1/2-14
12-12-12	3/4-14	3/4-14	3/4-14
16-16-16	1-11 1/2	1-11 1/2	1-11 1/2
20-20-20	1 1/4-11 1/2	1 1/4-11 1/2	1 1/4-11 1/2
24-24-24	1 1/2-11 1/2	1 1/2-11 1/2	1 1/2-11 1/2
32-32-32	2-11 1/2	2-11 1/2	2-11 1/2

AVAILABILITY

- » Import Steel
- » Steel
- » Import Stainless Steel
- » Stainless Steel

COMPLIANCE

- » SAE 140438

Pipe Cross

SHAPE

Cross

Dash Size	Male Pipe	Male Pipe	Male Pipe	Male Pipe
04-04-04-04	1/4-18	1/4-18	1/4-18	1/4-18
12-12-12-12	3/4-14	3/4-14	3/4-14	3/4-14

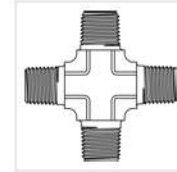

5650

AVAILABILITY

- » Import Steel
- » Steel

Pipe Cross

SHAPE

Cross

Dash Size	Female Pipe	Female Pipe	Female Pipe	Female Pipe
02-02-02-02	1/8-27	1/8-27	1/8-27	1/8-27
04-04-04-04	1/4-18	1/4-18	1/4-18	1/4-18
06-06-06-06	3/8-18	3/8-18	3/8-18	3/8-18
08-08-08-08	1/2-14	1/2-14	1/2-14	1/2-14
12-12-12-12	3/4-14	3/4-14	3/4-14	3/4-14
16-16-16-16	1-11 1/2	1-11 1/2	1-11 1/2	1-11 1/2
20-20-20-20	1 1/4-11 1/2	1 1/4-11 1/2	1 1/4-11 1/2	1 1/4-11 1/2
24-24-24-24	1 1/2-11 1/2	1 1/2-11 1/2	1 1/2-11 1/2	1 1/2-11 1/2
32-32-32-32	2-11 1/2	2-11 1/2	2-11 1/2	2-11 1/2

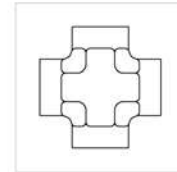

5652

COMPLIANCE

- » SAE 140538

AVAILABILITY

- » Import Steel
- » Steel
- » Import Stainless Steel
- » Stainless Steel

Pipe Cross

SHAPE

Cross

Dash Size	Male Pipe	Female Pipe	Female Pipe	Female Pipe
04-04-04-04	1/4-18	1/4-18	1/4-18	1/4-18
06-06-06-06	3/8-18	3/8-18	3/8-18	3/8-18
08-08-08-08	1/2-14	1/2-14	1/2-14	1/2-14
12-12-12-12	3/4-14	3/4-14	3/4-14	3/4-14

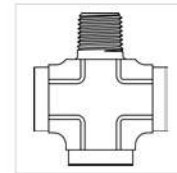

5655

AVAILABILITY

- » Import Steel
- » Steel

O-Ring to Pipe

SHAPE

Straight

Dash Size	Male O-Ring	Male Pipe
03-02	3/8-24	1/8-27
04-02	7/16-20	1/8-27
04-04	7/16-20	1/4-18
04-06	7/16-20	3/8-18
05-02	1/2-20	1/8-27
05-04	1/2-20	1/4-18
06-04	9/16-18	1/4-18
06-06	9/16-18	3/8-18
06-08	9/16-18	1/2-14
08-04	3/4-16	1/4-18
08-06	3/4-16	3/8-18
08-08	3/4-16	1/2-14
08-12	3/4-16	3/4-14
10-06	7/8-14	3/8-18

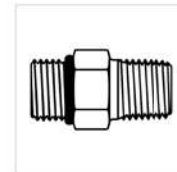

6401

AVAILABILITY

- » Import Steel
- » Steel
- » Import Stainless Steel
- » Stainless Steel

▼ 6401 continues

6401
▼ continued

Dash Size	Male O-Ring	Male Pipe
10-08	7/8-14	1/2-14
10-12	7/8-14	3/4-14
12-08	1 1/16-12	1/2-14
12-12	1 1/16-12	3/4-14
12-16	1 1/16-12	1-11 1/2
16-12	1 5/16-12	3/4-14
16-16	1 5/16-12	1-11 1/2
16-20	1 5/16-12	1 1/4-11 1/2
20-20	1 5/8-12	1 1/4-11 1/2
24-16	1 7/8-12	1-11 1/2
24-20	1 7/8-12	1 1/4-11 1/2
24-24	1 7/8-12	1 1/2-11 1/2
32-32	2 1/2-12	2-11 1/2

6404

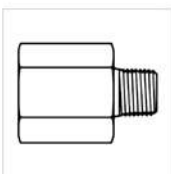

O-Ring to Pipe

SHAPE

Straight

AVAILABILITY

- » Import Steel
- » Steel
- » Stainless Steel

Dash Size	Female O-Ring	Male Pipe
04-02	7/16-20	1/8-27
04-04	7/16-20	1/4-18
04-06	7/16-20	3/8-18
05-02	1/2-20	1/8-27
05-04	1/2-20	1/4-18
06-04	9/16-18	1/4-18
06-06	9/16-18	3/8-18
06-08	9/16-18	1/2-14
08-04	3/4-16	1/4-18
08-06	3/4-16	3/8-18
08-08	3/4-16	1/2-14
08-12	3/4-16	3/4-14
08-16	3/4-16	1-11 1/2
10-06	7/8-14	3/8-18
10-08	7/8-14	1/2-14
10-12	7/8-14	3/4-14
12-08	1 1/16-12	1/2-14
12-12	1 1/16-12	3/4-14
12-16	1 1/16-12	1-11 1/2
14-12	1 3/16-12	3/4-14
16-12	1 5/16-12	3/4-14
16-16	1 5/16-12	1-11 1/2
20-20	1 5/8-12	1 1/4-11 1/2
24-24	1 7/8-12	1 1/2-11 1/2
32-32	2 1/2-12	2-11 1/2

O-Ring to Pipe

SHAPE

Straight

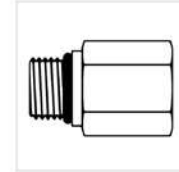

6405

Dash Size	Male O-Ring	Female Pipe
02-02	5/16-24	1/8-27
02-04	5/16-24	1/4-18
03-02	3/8-24	1/8-27
03-04	3/8-24	1/4-18
04-02	7/16-20	1/8-27
04-04	7/16-20	1/4-18
04-06	7/16-20	3/8-18
05-02	1/2-20	1/8-27
05-04	1/2-20	1/4-18
06-02	9/16-18	1/8-27
06-04	9/16-18	1/4-18
06-06	9/16-18	3/8-18
06-08	9/16-18	1/2-14
06-12	9/16-18	3/4-14
08-02	3/4-16	1/8-27
08-04	3/4-16	1/4-18
08-06	3/4-16	3/8-18
08-08	3/4-16	1/2-14
08-12	3/4-16	3/4-14
10-02	7/8-14	1/8-27
10-04	7/8-14	1/4-18
10-06	7/8-14	3/8-18
10-08	7/8-14	1/2-14
10-12	7/8-14	3/4-14
12-04	1 1/16-12	1/4-18
12-06	1 1/16-12	3/8-18
12-08	1 1/16-12	1/2-14
12-12	1 1/16-12	3/4-14
12-16	1 1/16-12	1-11 1/2
12-20	1 1/16-12	1 1/4-11 1/2
12-24	1 1/16-12	1 1/2-11 1/2
14-08	1 3/16-12	1/2-14
14-12	1 3/16-12	3/4-14
14-16	1 3/16-12	1-11 1/2
16-04	1 5/16-12	1/4-18
16-06	1 5/16-12	3/8-18
16-08	1 5/16-12	1/2-14
16-12	1 5/16-12	3/4-14
16-16	1 5/16-12	1-11 1/2
16-20	1 5/16-12	1 1/4-11 1/2
20-08	1 5/8-12	1/2-14
20-12	1 5/8-12	3/4-14
20-16	1 5/8-12	1-11 1/2
20-20	1 5/8-12	1 1/4-11 1/2
20-24	1 5/8-12	1 1/2-11 1/2
24-12	1 7/8-12	3/4-14
24-16	1 7/8-12	1-11 1/2
24-20	1 7/8-12	1 1/4-11 1/2
24-24	1 7/8-12	1 1/2-11 1/2
32-20	2 1/2-12	1 1/4-11 1/2
32-24	2 1/2-12	1 1/2-11 1/2
32-32	2 1/2-12	2-11 1/2

AVAILABILITY

- » Import Steel
- » Steel
- » Import Stainless Steel
- » Stainless Steel

6420

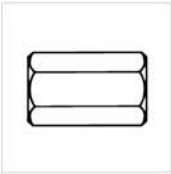

O-Ring to Pipe

SHAPE

Straight

Dash Size	Female O-Ring	Female Pipe
06-06	9/16-18	3/8-18
10-08	7/8-14	1/2-14
12-12	1 1/16-12	3/4-14
16-16	1 5/16-12	1-11 1/2

AVAILABILITY

» Steel

6805

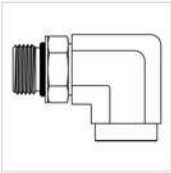

O-Ring to Pipe Elbow 90°

SHAPE

90 degree elbow

Dash Size	Male O-Ring	Female Pipe
04-02	7/16-20	1/8-27
04-04	7/16-20	1/4-18
05-02	1/2-20	1/8-27
06-02	9/16-18	1/8-27
06-04	9/16-18	1/4-18
06-06	9/16-18	3/8-18
08-06	3/4-16	3/8-18
08-08	3/4-16	1/2-14
10-06	7/8-14	3/8-18
10-08	7/8-14	1/2-14
10-12	7/8-14	3/4-14
12-08	1 1/16-12	1/2-14
12-12	1 1/16-12	3/4-14
14-12	1 3/16-12	3/4-14
16-12	1 5/16-12	3/4-14
16-16	1 5/16-12	1-11 1/2
20-20	1 5/8-12	1 1/4-11 1/2
24-24	1 7/8-12	1 1/2-11 1/2
32-32	2 1/2-12	2-11 1/2

AVAILABILITY

» Import Steel

» Steel

» Import Stainless Steel

» Stainless Steel

6805-L

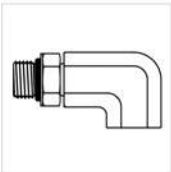

O-Ring to Pipe Elbow 90° - Long

Drop Length = Middle of Female Pipe to End of Male O-Ring Threads.

SHAPE

90 degree elbow

Dash Size	Male O-Ring	Female Pipe	Drop Length
08-06	3/4-16	3/8-18	2.94
08-08	3/4-16	1/2-14	3.56
10-08	7/8-14	1/2-14	3.56
12-12	1 1/16-12	3/4-14	4.13
16-16	1 5/16-12	1-11 1/2	4.63

AVAILABILITY

» Import Steel

» Steel

O-Ring to Pipe Elbow 90°

SHAPE

90 degree elbow

Dash Size	Male O-Ring	Male Pipe
04-02	7/16-20	1/8-27
04-04	7/16-20	1/4-18
05-02	1/2-20	1/8-27
06-04	9/16-18	1/4-18
06-06	9/16-18	3/8-18
06-08	9/16-18	1/2-14
08-06	3/4-16	3/8-18
08-08	3/4-16	1/2-14
10-08	7/8-14	1/2-14
12-12	1 1/16-12	3/4-14
14-12	1 3/16-12	3/4-14
16-12	1 5/16-12	3/4-14
16-16	1 5/16-12	1-11 1/2
20-20	1 5/8-12	1 1/4-11 1/2
24-24	1 7/8-12	1 1/2-11 1/2
32-32	2 1/2-12	2-11 1/2

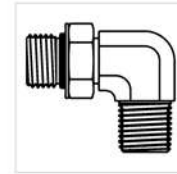

6806

AVAILABILITY

- » Import Steel
- » Steel

Pipe to O-Ring Branch Tee

SHAPE

Tee

Dash Size	Female Pipe	Female Pipe	Male O-Ring
04-04-06	1/4-18	1/4-18	9/16-18
06-06-04	3/8-18	3/8-18	7/16-20
06-06-06	3/8-18	3/8-18	9/16-18
06-08-08	3/8-18	1/2-14	3/4-16

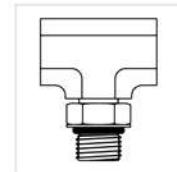

6855

AVAILABILITY

- » Steel

Pipe Swivel Adapters

1404

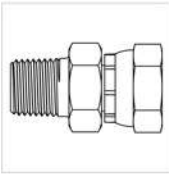

Pipe to Pipe Swivel

RST - Available in restricted orifice, contact a Customer Service Representative at (800) 255-1008 for availability.

SHAPE

Straight

Dash Size	Male Pipe	Female Pipe Swivel
02-02	1/8-27	1/8-27
02-04	1/8-27	1/4-18
04-02	1/4-18	1/8-27
04-04	1/4-18	1/4-18
04-06	1/4-18	3/8-18
04-08	1/4-18	1/2-14
06-04	3/8-18	1/4-18
06-06	3/8-18	3/8-18
06-08	3/8-18	1/2-14
08-04	1/2-14	1/4-18
08-06	1/2-14	3/8-18
08-08	1/2-14	1/2-14
08-12	1/2-14	3/4-14
12-06	3/4-14	3/8-18
12-08	3/4-14	1/2-14
12-12	3/4-14	3/4-14
12-16	3/4-14	1-11 1/2
16-06	1-11 1/2	3/8-18
16-08	1-11 1/2	1/2-14
16-12	1-11 1/2	3/4-14
16-16	1-11 1/2	1-11 1/2
16-20	1-11 1/2	1 1/4-11 1/2
16-24	1-11 1/2	1 1/2-11 1/2
20-16	1 1/4-11 1/2	1-11 1/2
20-20	1 1/4-11 1/2	1 1/4-11 1/2
20-24	1 1/4-11 1/2	1 1/2-11 1/2
24-20	1 1/2-11 1/2	1 1/4-11 1/2
24-24	1 1/2-11 1/2	1 1/2-11 1/2
32-32	2-11 1/2	2-11 1/2
48-48	3-8	3-8

AVAILABILITY

- » Import Steel
- » Steel
- » Import Stainless Steel
- » Stainless Steel

COMPLIANCE

- » SAE 140130

1405

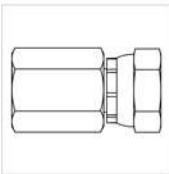

Pipe to Pipe Swivel

SHAPE

Straight

Dash Size	Female Pipe	Female Pipe Swivel
02-02	1/8-27	1/8-27
02-04	1/8-27	1/4-18
04-02	1/4-18	1/8-27
04-04	1/4-18	1/4-18
04-06	1/4-18	3/8-18
04-08	1/4-18	1/2-14
06-04	3/8-18	1/4-18
06-06	3/8-18	3/8-18
06-08	3/8-18	1/2-14

AVAILABILITY

- » Import Steel
- » Steel
- » Import Stainless Steel
- » Stainless Steel

COMPLIANCE

- » SAE 140131

Dash Size	Female Pipe	Female Pipe Swivel
08-04	1/2-14	1/4-18
08-06	1/2-14	3/8-18
08-08	1/2-14	1/2-14
08-12	1/2-14	3/4-14
12-06	3/4-14	3/8-18
12-08	3/4-14	1/2-14
12-12	3/4-14	3/4-14
12-16	3/4-14	1-11 1/2
16-12	1-11 1/2	3/4-14
16-16	1-11 1/2	1-11 1/2
20-20	1 1/4-11 1/2	1 1/4-11 1/2
24-24	1 1/2-11 1/2	1 1/2-11 1/2
32-32	2-11 1/2	2-11 1/2

1405
▼ continued

Pipe Dual Swivel Union

SHAPE

Straight

Dash Size	Female Pipe Swivel	Female Pipe Swivel
04-04	1/4-18	1/4-18
06-06	3/8-18	3/8-18
08-08	1/2-14	1/2-14
12-12	3/4-14	3/4-14
16-16	1-11 1/2	1-11 1/2
20-20	1 1/4-11 1/2	1 1/4-11 1/2

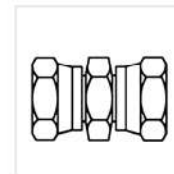

1406

AVAILABILITY
» Import Steel
» Steel

Pipe to Pipe Swivel Elbow 90°

RST - Available in restricted orifice, contact a Customer Service Representative at (800) 255-1008 for availability.

SHAPE

90 degree elbow

Dash Size	Male Pipe	Female Pipe Swivel
02-02	1/8-27	1/8-27
02-04	1/8-27	1/4-18
04-02	1/4-18	1/8-27
04-04	1/4-18	1/4-18
04-06	1/4-18	3/8-18
04-08	1/4-18	1/2-14
06-04	3/8-18	1/4-18
06-06	3/8-18	3/8-18
06-08	3/8-18	1/2-14
06-12	3/8-18	3/4-14
08-04	1/2-14	1/4-18
08-06	1/2-14	3/8-18
08-08	1/2-14	1/2-14
08-12	1/2-14	3/4-14
12-04	3/4-14	1/4-18
12-06	3/4-14	3/8-18
12-08	3/4-14	1/2-14
12-12	3/4-14	3/4-14
12-16	3/4-14	1-11 1/2
12-20	3/4-14	1 1/4-11 1/2
16-08	1-11 1/2	1/2-14

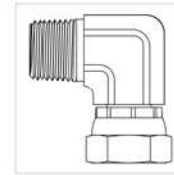

1501

COMPLIANCE
» SAE 140230

AVAILABILITY
» Import Steel
» Steel
» Import Stainless Steel
» Stainless Steel

▼ 1501 continues

1501

▼ continued

Dash Size	Male Pipe	Female Pipe Swivel
16-12	1-11 1/2	3/4-14
16-16	1-11 1/2	1-11 1/2
16-20	1-11 1/2	1 1/4-11 1/2
20-12	1 1/4-11 1/2	3/4-14
20-16	1 1/4-11 1/2	1-11 1/2
20-20	1 1/4-11 1/2	1 1/4-11 1/2
20-24	1 1/4-11 1/2	1 1/2-11 1/2
24-20	1 1/2-11 1/2	1 1/4-11 1/2
24-24	1 1/2-11 1/2	1 1/2-11 1/2
32-32	2-11 1/2	2-11 1/2

1501-LL



Pipe to Pipe Swivel Elbow 90° - Extra Long

Drop Length = Middle of NPSM to End of Male Pipe Threads.

SHAPE

90 degree elbow

Dash Size	Male Pipe	Female Pipe Swivel	Drop Length
02-02	1/8-27	1/8-27	1.64
04-04	1/4-18	1/4-18	2.25
06-06	3/8-18	3/8-18	2.76
08-08	1/2-14	1/2-14	3.19
12-12	3/4-14	3/4-14	3.66
16-16	1-11 1/2	1-11 1/2	4.33

AVAILABILITY

- » Import Steel
- » Steel

1502

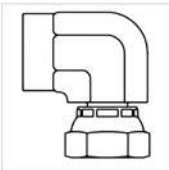

Pipe to Pipe Swivel Elbow 90°

SHAPE

90 degree elbow

Dash Size	Female Pipe	Female Pipe Swivel
02-02	1/8-27	1/8-27
02-04	1/8-27	1/4-18
04-02	1/4-18	1/8-27
04-04	1/4-18	1/4-18
04-06	1/4-18	3/8-18
06-04	3/8-18	1/4-18
06-06	3/8-18	3/8-18
06-08	3/8-18	1/2-14
08-04	1/2-14	1/4-18
08-06	1/2-14	3/8-18
08-08	1/2-14	1/2-14
08-12	1/2-14	3/4-14
12-08	3/4-14	1/2-14
12-12	3/4-14	3/4-14
12-16	3/4-14	1-11 1/2
16-12	1-11 1/2	3/4-14
16-16	1-11 1/2	1-11 1/2
20-20	1 1/4-11 1/2	1 1/4-11 1/2
24-24	1 1/2-11 1/2	1 1/2-11 1/2
32-32	2-11 1/2	2-11 1/2

AVAILABILITY

- » Import Steel
- » Steel
- » Import Stainless Steel
- » Stainless Steel

COMPLIANCE

- » SAE 140231

Pipe to Pipe Swivel Elbow 45°

SHAPE

45 degree elbow

Dash Size	Male Pipe	Female Pipe Swivel
02-02	1/8-27	1/8-27
02-04	1/8-27	1/4-18
04-02	1/4-18	1/8-27
04-04	1/4-18	1/4-18
04-06	1/4-18	3/8-18
06-04	3/8-18	1/4-18
06-06	3/8-18	3/8-18
06-08	3/8-18	1/2-14
08-04	1/2-14	1/4-18
08-06	1/2-14	3/8-18
08-08	1/2-14	1/2-14
08-12	1/2-14	3/4-14
12-06	3/4-14	3/8-18
12-08	3/4-14	1/2-14
12-12	3/4-14	3/4-14
12-16	3/4-14	1-11 1/2
16-12	1-11 1/2	3/4-14
16-16	1-11 1/2	1-11 1/2
16-20	1-11 1/2	1 1/4-11 1/2
20-16	1 1/4-11 1/2	1-11 1/2
20-20	1 1/4-11 1/2	1 1/4-11 1/2
24-24	1 1/2-11 1/2	1 1/2-11 1/2
32-32	2-11 1/2	2-11 1/2

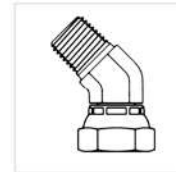

1503

COMPLIANCE

» SAE 140330

AVAILABILITY

- » Import Steel
- » Steel
- » Import Stainless Steel
- » Stainless Steel

Pipe to Pipe Swivel Elbow 45°

SHAPE

45 degree elbow

Dash Size	Female Pipe	Female Pipe Swivel
02-02	1/8-27	1/8-27
02-04	1/8-27	1/4-18
04-02	1/4-18	1/8-27
04-04	1/4-18	1/4-18
06-04	3/8-18	1/4-18
06-06	3/8-18	3/8-18
08-06	1/2-14	3/8-18
08-08	1/2-14	1/2-14
12-08	3/4-14	1/2-14
12-12	3/4-14	3/4-14
16-12	1-11 1/2	3/4-14
16-16	1-11 1/2	1-11 1/2
20-20	1 1/4-11 1/2	1 1/4-11 1/2
24-24	1 1/2-11 1/2	1 1/2-11 1/2



1504

COMPLIANCE

» SAE 140331

AVAILABILITY

- » Import Steel
- » Steel
- » Import Stainless Steel

1601

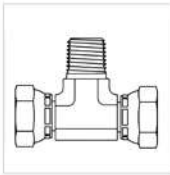

AVAILABILITY

- » Import Steel
- » Steel

Pipe Swivel Branch Tee

SHAPE

Tee

Dash Size	Male Pipe	Female Pipe Swivel	Female Pipe Swivel
02-02-02	1/8-27	1/8-27	1/8-27
04-04-04	1/4-18	1/4-18	1/4-18
04-06-06	1/4-18	3/8-18	3/8-18
06-04-04	3/8-18	1/4-18	1/4-18
06-06-06	3/8-18	3/8-18	3/8-18
06-08-08	3/8-18	1/2-14	1/2-14
08-04-04	1/2-14	1/4-18	1/4-18
08-06-06	1/2-14	3/8-18	3/8-18
08-08-08	1/2-14	1/2-14	1/2-14
12-08-08	3/4-14	1/2-14	1/2-14
12-12-12	3/4-14	3/4-14	3/4-14
12-16-16	3/4-14	1-11 1/2	1-11 1/2
16-12-12	1-11 1/2	3/4-14	3/4-14
16-16-16	1-11 1/2	1-11 1/2	1-11 1/2
20-20-20	1 1/4-11 1/2	1 1/4-11 1/2	1 1/4-11 1/2
24-24-24	1 1/2-11 1/2	1 1/2-11 1/2	1 1/2-11 1/2

1602

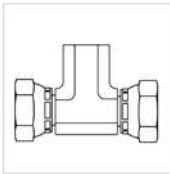

AVAILABILITY

- » Import Steel
- » Steel

Pipe Swivel Branch Tee

SHAPE

Tee

Dash Size	Female Pipe	Female Pipe Swivel	Female Pipe Swivel
02-02-02	1/8-27	1/8-27	1/8-27
04-04-04	1/4-18	1/4-18	1/4-18
06-04-04	3/8-18	1/4-18	1/4-18
06-06-06	3/8-18	3/8-18	3/8-18
06-08-08	3/8-18	1/2-14	1/2-14
08-06-06	1/2-14	3/8-18	3/8-18
08-08-08	1/2-14	1/2-14	1/2-14
12-08-08	3/4-14	1/2-14	1/2-14
12-12-12	3/4-14	3/4-14	3/4-14
16-12-12	1-11 1/2	3/4-14	3/4-14
16-16-16	1-11 1/2	1-11 1/2	1-11 1/2
20-20-20	1 1/4-11 1/2	1 1/4-11 1/2	1 1/4-11 1/2
24-24-24	1 1/2-11 1/2	1 1/2-11 1/2	1 1/2-11 1/2

1603

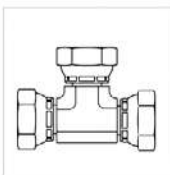

AVAILABILITY

- » Import Steel
- » Steel

Pipe Swivel Union Tee

SHAPE

Tee

Dash Size	Female Pipe Swivel	Female Pipe Swivel	Female Pipe Swivel
02-02-02	1/8-27	1/8-27	1/8-27
04-04-04	1/4-18	1/4-18	1/4-18
06-06-06	3/8-18	3/8-18	3/8-18
08-08-08	1/2-14	1/2-14	1/2-14
12-12-12	3/4-14	3/4-14	3/4-14
16-16-16	1-11 1/2	1-11 1/2	1-11 1/2
20-20-20	1 1/4-11 1/2	1 1/4-11 1/2	1 1/4-11 1/2

Pipe Swivel Cross

SHAPE

Cross

Dash Size	Male Pipe	Female Pipe Swivel	Female Pipe Swivel	Female Pipe Swivel
04-04-04-04	1/4-18	1/4-18	1/4-18	1/4-18
06-06-06-06	3/8-18	3/8-18	3/8-18	3/8-18
08-08-08-08	1/2-14	1/2-14	1/2-14	1/2-14

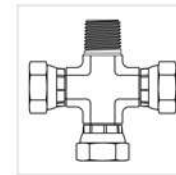

1604

AVAILABILITY

» Steel

O-Ring to Pipe Swivel

SHAPE

Straight

Dash Size	Male O-Ring	Female Pipe Swivel
04-02	7/16-20	1/8-27
04-04	7/16-20	1/4-18
04-06	7/16-20	3/8-18
04-08	7/16-20	1/2-14
05-04	1/2-20	1/4-18
05-06	1/2-20	3/8-18
05-08	1/2-20	1/2-14
06-04	9/16-18	1/4-18
06-06	9/16-18	3/8-18
06-08	9/16-18	1/2-14
08-04	3/4-16	1/4-18
08-06	3/4-16	3/8-18
08-08	3/4-16	1/2-14
08-12	3/4-16	3/4-14
10-04	7/8-14	1/4-18
10-06	7/8-14	3/8-18
10-08	7/8-14	1/2-14
10-12	7/8-14	3/4-14
12-06	1 1/16-12	3/8-18
12-08	1 1/16-12	1/2-14
12-12	1 1/16-12	3/4-14
12-16	1 1/16-12	1-11 1/2
14-12	1 3/16-12	3/4-14
14-16	1 3/16-12	1-11 1/2
16-08	1 5/16-12	1/2-14
16-12	1 5/16-12	3/4-14
16-16	1 5/16-12	1-11 1/2
16-20	1 5/16-12	1 1/4-11 1/2
20-12	1 5/8-12	3/4-14
20-16	1 5/8-12	1-11 1/2
20-20	1 5/8-12	1 1/4-11 1/2
24-20	1 7/8-12	1 1/4-11 1/2
24-24	1 7/8-12	1 1/2-11 1/2
32-32	2 1/2-12	2-11 1/2

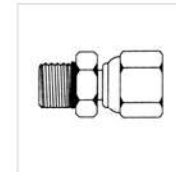

6900

COMPLIANCE

» SAE 140157

AVAILABILITY

» Import Steel

» Steel

» Stainless Steel

6901

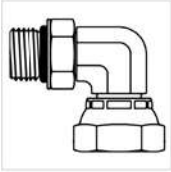

O-Ring to Pipe Swivel Elbow 90°

SHAPE

90 degree elbow

Dash Size	Male O-Ring	Female Pipe Swivel
04-02	7/16-20	1/8-27
04-04	7/16-20	1/4-18
04-06	7/16-20	3/8-18
06-04	9/16-18	1/4-18
06-06	9/16-18	3/8-18
06-08	9/16-18	1/2-14
08-04	3/4-16	1/4-18
08-06	3/4-16	3/8-18
08-08	3/4-16	1/2-14
08-12	3/4-16	3/4-14
10-06	7/8-14	3/8-18
10-08	7/8-14	1/2-14
10-12	7/8-14	3/4-14
12-06	1 1/16-12	3/8-18
12-08	1 1/16-12	1/2-14
12-12	1 1/16-12	3/4-14
12-16	1 1/16-12	1-11 1/2
14-12	1 3/16-12	3/4-14
16-12	1 5/16-12	3/4-14
16-16	1 5/16-12	1-11 1/2
16-20	1 5/16-12	1 1/4-11 1/2
20-12	1 5/8-12	3/4-14
20-16	1 5/8-12	1-11 1/2
20-20	1 5/8-12	1 1/4-11 1/2
24-24	1 7/8-12	1 1/2-11 1/2
32-32	2 1/2-12	2-11 1/2

AVAILABILITY

- » Import Steel
- » Steel

COMPLIANCE

- » SAE 140257

O-Ring to Pipe Swivel Elbow 45°

SHAPE

45 degree elbow

Dash Size	Male O-Ring	Female Pipe Swivel
04-02	7/16-20	1/8-27
04-04	7/16-20	1/4-18
04-06	7/16-20	3/8-18
06-04	9/16-18	1/4-18
06-06	9/16-18	3/8-18
06-08	9/16-18	1/2-14
08-04	3/4-16	1/4-18
08-06	3/4-16	3/8-18
08-08	3/4-16	1/2-14
08-12	3/4-16	3/4-14
10-06	7/8-14	3/8-18
10-08	7/8-14	1/2-14
10-12	7/8-14	3/4-14
12-08	1 1/16-12	1/2-14
12-12	1 1/16-12	3/4-14
12-16	1 1/16-12	1-11 1/2
16-12	1 5/16-12	3/4-14
16-16	1 5/16-12	1-11 1/2
16-20	1 5/16-12	1 1/4-11 1/2
20-20	1 5/8-12	1 1/4-11 1/2
24-24	1 7/8-12	1 1/2-11 1/2

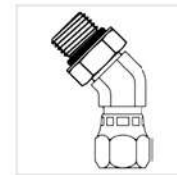

6902

COMPLIANCE

» SAE 140357

AVAILABILITY

- » Import Steel
- » Steel

O-Ring to Pipe Swivel Branch Tee

SHAPE

Tee

Dash Size	Male O-Ring	Female Pipe Swivel	Female Pipe Swivel
04-04-04	7/16-20	1/4-18	1/4-18
06-06-06	9/16-18	3/8-18	3/8-18
08-04-04	3/4-16	1/4-18	1/4-18
08-06-06	3/4-16	3/8-18	3/8-18
08-08-08	3/4-16	1/2-14	1/2-14
12-12-12	1 1/16-12	3/4-14	3/4-14

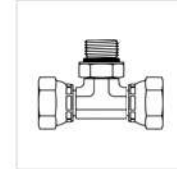

6911

AVAILABILITY

- » Import Steel
- » Steel

O-Ring Face Seal Adapters

FF2402

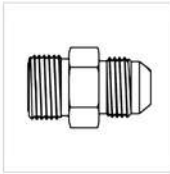

ORFS to JIC

SHAPE

Straight

Dash Size	Male O-Ring Face Seal	Male JIC
04-04	9/16-18	7/16-20
06-06	11/16-16	9/16-18
08-08	13/16-16	3/4-16
10-10	1-14	7/8-14
12-12	1 3/16-12	1 1/16-12
16-16	1 7/16-12	1 5/8-12
20-20	1 11/16-12	1 5/8-12
24-24	2-12	1 7/8-12

AVAILABILITY

- » Import Steel
- » Steel

FF2403

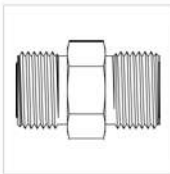

ORFS Union

SHAPE

Straight

Dash Size	Male O-Ring Face Seal	Male O-Ring Face Seal
04-04	9/16-18	9/16-18
06-04	11/16-16	9/16-18
06-06	11/16-16	11/16-16
08-06	13/16-16	11/16-16
08-08	13/16-16	13/16-16
10-08	1-14	13/16-16
10-10	1-14	1-14
12-08	1 3/16-12	13/16-16
12-10	1 3/16-12	1-14
12-12	1 3/16-12	1 3/16-12
16-12	1 7/16-12	1 3/16-12
16-16	1 7/16-12	1 7/16-12
20-16	1 11/16-12	1 7/16-12
20-20	1 11/16-12	1 11/16-12
24-20	2-12	1 11/16-12
24-24	2-12	2-12

AVAILABILITY

- » Import Steel
- » Steel
- » Import Stainless Steel

COMPLIANCE

- » SAE 520101

ORFS to Pipe

SHAPE

Straight

Dash Size	Male O-Ring Face Seal	Male Pipe
04-02	9/16-18	1/8-27
04-04	9/16-18	1/4-18
04-06	9/16-18	3/8-18
04-08	9/16-18	1/2-14
06-02	11/16-16	1/8-27
06-04	11/16-16	1/4-18
06-06	11/16-16	3/8-18
06-08	11/16-16	1/2-14
08-04	13/16-16	1/4-18
08-06	13/16-16	3/8-18
08-08	13/16-16	1/2-14
08-12	13/16-16	3/4-14
08-16	13/16-16	1-11 1/2
10-08	1-14	1/2-14
10-12	1-14	3/4-14
10-16	1-14	1-11 1/2
12-08	1 3/16-12	1/2-14
12-12	1 3/16-12	3/4-14
12-16	1 3/16-12	1-11 1/2
16-12	1 7/16-12	3/4-14
16-16	1 7/16-12	1-11 1/2
16-20	1 7/16-12	1 1/4-11 1/2
16-24	1 7/16-12	1 1/2-11 1/2
20-16	1 11/16-12	1-11 1/2
20-20	1 11/16-12	1 1/4-11 1/2
20-24	1 11/16-12	1 1/2-11 1/2
24-20	2-12	1 1/4-11 1/2
24-24	2-12	1 1/2-11 1/2

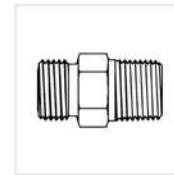

FF2404

COMPLIANCE
» SAE 520102

AVAILABILITY
» Import Steel
» Steel
» Import Stainless Steel

ORFS to Pipe

SHAPE

Straight

Dash Size	Male O-Ring Face Seal	Female Pipe
04-04	9/16-18	1/4-18
04-08	9/16-18	1/2-14
06-04	11/16-16	1/4-18
06-06	11/16-16	3/8-18
06-08	11/16-16	1/2-14
08-06	13/16-16	3/8-18
08-08	13/16-16	1/2-14
08-12	13/16-16	3/4-14
10-08	1-14	1/2-14
12-12	1 3/16-12	3/4-14
12-16	1 3/16-12	1-11 1/2
16-16	1 7/16-12	1-11 1/2
16-20	1 7/16-12	1 1/4-11 1/2
20-20	1 11/16-12	1 1/4-11 1/2
24-24	2-12	1 1/2-11 1/2

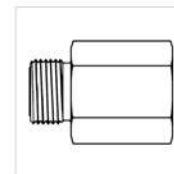

FF2405

AVAILABILITY
» Import Steel
» Steel

FF2406

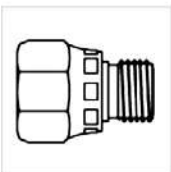

ORFS Swivel to ORFS Reducer

Can also use FF2407 (Face Seal Reducer) and FF318 (Flat Face Nut) combination.

SHAPE

Straight

Dash Size	Female O-Ring Face Seal Swivel	Male O-Ring Face Seal
06-04	11/16-16	9/16-18
08-04	13/16-16	9/16-18
08-06	13/16-16	11/16-16
08-08	13/16-16	13/16-16
10-04	1-14	9/16-18
10-06	1-14	11/16-16
10-08	1-14	13/16-16
12-04	1 3/16-12	9/16-18
12-06	1 3/16-12	11/16-16
12-08	1 3/16-12	13/16-16
12-10	1 3/16-12	1-14
16-04	1 7/16-12	9/16-18
16-06	1 7/16-12	11/16-16
16-08	1 7/16-12	13/16-16
16-10	1 7/16-12	1-14
16-12	1 7/16-12	1 3/16-12
16-20	1 7/16-12	1 11/16-12
20-04	1 11/16-12	9/16-18
20-06	1 11/16-12	11/16-16
20-08	1 11/16-12	13/16-16
20-12	1 11/16-12	1 3/16-12
20-16	1 11/16-12	1 7/16-12
20-24	1 11/16-12	2-12
24-12	2-12	1 3/16-12
24-16	2-12	1 7/16-12
24-20	2-12	1 11/16-12

AVAILABILITY

- » Import Steel
- » Steel

FF2407

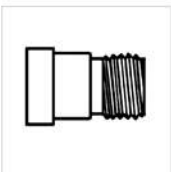

ORFS to ORFS Reducer

Requires item FF318 Flat Face Nut for assembly.

SHAPE

Straight

Dash Size	Female O-Ring Face Seal	Male O-Ring Face Seal
08-04	13/16-16	9/16-18
08-06	13/16-16	11/16-16
10-04	1-14	9/16-18
10-06	1-14	11/16-16
10-08	1-14	13/16-16
12-04	1 3/16-12	9/16-18
12-06	1 3/16-12	11/16-16
12-08	1 3/16-12	13/16-16
16-04	1 7/16-12	9/16-18
16-06	1 7/16-12	11/16-16
16-08	1 7/16-12	13/16-16
16-10	1 7/16-12	1-14
20-04	1 11/16-12	9/16-18
20-06	1 11/16-12	11/16-16
20-08	1 11/16-12	13/16-16
24-16	2-12	1 7/16-12

AVAILABILITY

- » Steel

ORFS Plug

SHAPE

Plug

Dash Size	Male O-Ring Face Seal
04	9/16-18
06	11/16-16
08	13/16-16
10	1-14
12	1 3/16-12
16	1 7/16-12
20	1 11/16-12
24	2-12

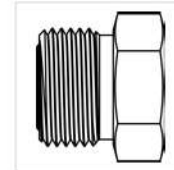

FF2408

COMPLIANCE
» SAE 520109

AVAILABILITY
» Import Steel
» Steel

ORFS Union Elbow 90°

SHAPE

90 degree elbow

Dash Size	Male O-Ring Face Seal	Male O-Ring Face Seal
04-04	9/16-18	9/16-18
06-04	11/16-16	9/16-18
06-06	11/16-16	11/16-16
08-08	13/16-16	13/16-16
10-10	1-14	1-14
12-08	1 3/16-12	13/16-16
12-12	1 3/16-12	1 3/16-12
16-12	1 7/16-12	1 3/16-12
16-16	1 7/16-12	1 7/16-12
20-16	1 11/16-12	1 7/16-12
20-20	1 11/16-12	1 11/16-12
24-24	2-12	2-12

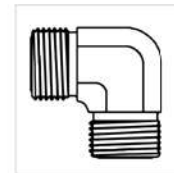

FF2500

COMPLIANCE
» SAE 520201

AVAILABILITY
» Import Steel
» Import Stainless Steel

ORFS to Pipe Elbow 90°

SHAPE

90 degree elbow

Dash Size	Male O-Ring Face Seal	Male Pipe
04-02	9/16-18	1/8-27
04-04	9/16-18	1/4-18
04-06	9/16-18	3/8-18
04-08	9/16-18	1/2-14
06-04	11/16-16	1/4-18
06-06	11/16-16	3/8-18
06-08	11/16-16	1/2-14
08-04	13/16-16	1/4-18
08-06	13/16-16	3/8-18
08-08	13/16-16	1/2-14
08-12	13/16-16	3/4-14
10-08	1-14	1/2-14
10-12	1-14	3/4-14
10-16	1-14	1-11 1/2
12-08	1 3/16-12	1/2-14
12-12	1 3/16-12	3/4-14
12-16	1 3/16-12	1-11 1/2
16-12	1 7/16-12	3/4-14

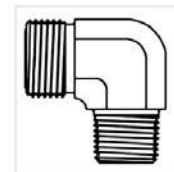

FF2501

COMPLIANCE
» SAE 520202

AVAILABILITY
» Import Steel
» Import Stainless Steel

▼ FF2501 continues

FF2501

▼ continued

Dash Size	Male O-Ring Face Seal	Male Pipe
16-16	1 7/16-12	1-11 1/2
20-16	1 11/16-12	1-11 1/2
20-20	1 11/16-12	1 1/4-11 1/2
24-24	2-12	1 1/2-11 1/2

FF2503

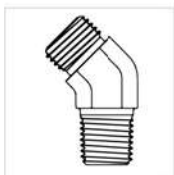

ORFS to Pipe Elbow 45°

SHAPE

45 degree elbow

Dash Size	Male O-Ring Face Seal	Male Pipe
04-02	9/16-18	1/8-27
04-04	9/16-18	1/4-18
06-04	11/16-16	1/4-18
06-06	11/16-16	3/8-18
08-06	13/16-16	3/8-18
08-08	13/16-16	1/2-14
10-08	1-14	1/2-14
12-12	1 3/16-12	3/4-14
16-12	1 7/16-12	3/4-14
16-16	1 7/16-12	1-11 1/2
20-16	1 11/16-12	1-11 1/2
20-20	1 11/16-12	1 1/4-11 1/2
24-24	2-12	1 1/2-11 1/2

AVAILABILITY

» Import Steel

COMPLIANCE

» SAE 520302

FF2601



ORFS to Pipe Branch Tee

SHAPE

Tee

Dash Size	Male O-Ring Face Seal	Male O-Ring Face Seal	Male Pipe
04-04-04	9/16-18	9/16-18	1/4-18
06-06-04	11/16-16	11/16-16	1/4-18
06-06-06	11/16-16	11/16-16	3/8-18
08-08-06	13/16-16	13/16-16	3/8-18
08-08-08	13/16-16	13/16-16	1/2-14
10-10-08	1-14	1-14	1/2-14
12-12-12	1 3/16-12	1 3/16-12	3/4-14
16-16-16	1 7/16-12	1 7/16-12	1-11 1/2
20-20-20	1 11/16-12	1 11/16-12	1 1/4-11 1/2

AVAILABILITY

» Import Steel

COMPLIANCE

» SAE 520425

FF2603

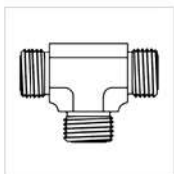

ORFS Union Tee

SHAPE

Tee

Dash Size	Male O-Ring Face Seal	Male O-Ring Face Seal	Male O-Ring Face Seal
04-04-04	9/16-18	9/16-18	9/16-18
06-05-08	11/16-16	05	13/16-16
06-06-06	11/16-16	11/16-16	11/16-16
08-08-08	13/16-16	13/16-16	13/16-16
10-10-10	1-14	1-14	1-14
12-12-12	1 3/16-12	1 3/16-12	1 3/16-12
16-16-16	1 7/16-12	1 7/16-12	1 7/16-12
20-20-20	1 11/16-12	1 11/16-12	1 11/16-12
24-24-24	2-12	2-12	2-12

AVAILABILITY

» Import Steel

COMPLIANCE

» SAE 520401

ORFS to Pipe Run Tee

SHAPE

Tee

Dash Size	Male O-Ring Face Seal	Male Pipe	Male O-Ring Face Seal
04-04-04	9/16-18	1/4-18	9/16-18
06-04-06	11/16-16	1/4-18	11/16-16
06-06-06	11/16-16	3/8-18	11/16-16
08-08-08	13/16-16	1/2-14	13/16-16

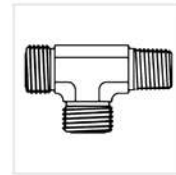

FF2605

COMPLIANCE
» SAE 520424

AVAILABILITY
» Import Steel

ORFS Union Cross

SHAPE

Cross

Dash Size	Male O-Ring Face Seal	Male O-Ring Face Seal	Male O-Ring Face Seal	Male O-Ring Face Seal
04-04-04-04	9/16-18	9/16-18	9/16-18	9/16-18
06-06-06-06	11/16-16	11/16-16	11/16-16	11/16-16
08-08-08-08	13/16-16	13/16-16	13/16-16	13/16-16
10-10-10-10	1-14	1-14	1-14	1-14
12-12-12-12	1 3/16-12	1 3/16-12	1 3/16-12	1 3/16-12
16-16-16-16	1 7/16-12	1 7/16-12	1 7/16-12	1 7/16-12
20-20-20-20	1 11/16-12	1 11/16-12	1 11/16-12	1 11/16-12
24-24-24-24	2-12	2-12	2-12	2-12

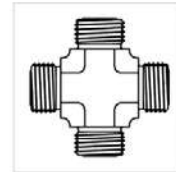

FF2650

COMPLIANCE
» SAE 520501

AVAILABILITY
» Import Steel

ORFS Bulkhead Union

To include locknut with bulkhead fitting add "LN" after base part number. Example FF2700-LN-04-04.

SHAPE

Straight

Dash Size	Male O-Ring Face Seal	Male O-Ring Face Seal
04-04	9/16-18	9/16-18
06-06	11/16-16	11/16-16
08-08	13/16-16	13/16-16
10-10	1-14	1-14
12-12	1 3/16-12	1 3/16-12
16-16	1 7/16-12	1 7/16-12
20-20	1 11/16-12	1 11/16-12
24-24	2-12	2-12

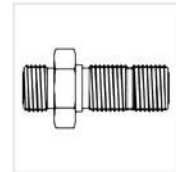

FF2700

COMPLIANCE
» SAE 520601

AVAILABILITY
» Import Steel
» Steel

ORFS Bulkhead Union 90°

To include locknut with bulkhead fitting add "LN" after base part number. Example FF2701-LN-04-04.

SHAPE

90 degree elbow

Dash Size	Male O-Ring Face Seal	Male O-Ring Face Seal
04-04	9/16-18	9/16-18
06-06	11/16-16	11/16-16
08-08	13/16-16	13/16-16
10-10	1-14	1-14
12-12	1 3/16-12	1 3/16-12
16-16	1 7/16-12	1 7/16-12
20-20	1 11/16-12	1 11/16-12
24-24	2-12	2-12

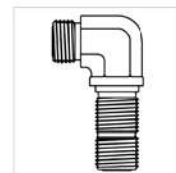

FF2701

COMPLIANCE
» SAE 520701

AVAILABILITY
» Import Steel

FF2702



ORFS Bulkhead Union 45°

To include locknut with bulkhead fitting add "LN" after base part number. Example FF2702-LN-04-04.

SHAPE

45 degree elbow

Dash Size	Male O-Ring Face Seal	Male O-Ring Face Seal
04-04	9/16-18	9/16-18
06-06	11/16-16	11/16-16
08-08	13/16-16	13/16-16
10-10	1-14	1-14
12-12	1 3/16-12	1 3/16-12
16-16	1 7/16-12	1 7/16-12
20-20	1 11/16-12	1 11/16-12
24-24	2-12	2-12

AVAILABILITY

» Import Steel

COMPLIANCE

» SAE 520801

FF2703

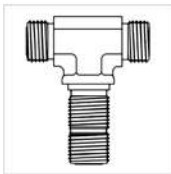

ORFS Bulkhead Union Branch Tee

To include locknut with bulkhead fitting add "LN" after base part number. Example FF2703-LN-04-04.

SHAPE

Tee

Dash Size	Male O-Ring Face Seal	Male O-Ring Face Seal	Male O-Ring Face Seal
04-04-04	9/16-18	9/16-18	9/16-18
06-06-06	11/16-16	11/16-16	11/16-16
08-08-08	13/16-16	13/16-16	13/16-16
10-10-10	1-14	1-14	1-14
12-12-12	1 3/16-12	1 3/16-12	1 3/16-12
16-16-16	1 7/16-12	1 7/16-12	1 7/16-12
20-20-20	1 11/16-12	1 11/16-12	1 11/16-12
24-24-24	2-12	2-12	2-12

AVAILABILITY

» Import Steel

COMPLIANCE

» SAE 520959

FF2704

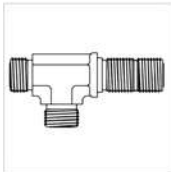

ORFS Bulkhead Union Run Tee

To include locknut with bulkhead fitting add "LN" after base part number. Example FF2704-LN-04-04.

SHAPE

Tee

Dash Size	Male O-Ring Face Seal	Male O-Ring Face Seal	Male O-Ring Face Seal
04-04-04	9/16-18	9/16-18	9/16-18
06-06-06	11/16-16	11/16-16	11/16-16
08-08-08	13/16-16	13/16-16	13/16-16
10-10-10	1-14	1-14	1-14
12-12-12	1 3/16-12	1 3/16-12	1 3/16-12
16-16-16	1 7/16-12	1 7/16-12	1 7/16-12
20-20-20	1 11/16-12	1 11/16-12	1 11/16-12
24-24-24	2-12	2-12	2-12

AVAILABILITY

» Import Steel

COMPLIANCE

» SAE 520958

ORFS to Pipe Bulkhead

To include locknut with bulkhead fitting add "LN" after base part number. Example FF2705-LN-04-04.

SHAPE

Straight

Dash Size	Male O-Ring Face Seal	Female Pipe
04-04	9/16-18	1/4-18
06-02	11/16-16	1/8-27
06-04	11/16-16	1/4-18
10-08	1-14	1/2-14

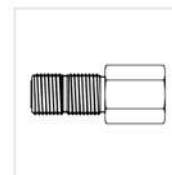

AVAILABILITY

» Steel

ORFS to Pipe Bulkhead

To include locknut with bulkhead fitting add "LN" after base part number. Example FF2706-LN-04-04.

SHAPE

Straight

Dash Size	Male O-Ring Face Seal	Male Pipe
04-02	9/16-18	1/8-27
04-04	9/16-18	1/4-18
06-04	11/16-16	1/4-18
06-06	11/16-16	3/8-18
08-08	13/16-16	1/2-14
12-12	1 3/16-12	3/4-14
16-16	1 7/16-12	1-11 1/2

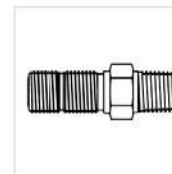

AVAILABILITY

» Steel

Flat Face Cap Insert

Insert into a FF318 (ORFS Tube Nut) to create a FF304-C-XX (ORFS Cap).

SHAPE

Cap

Dash Size	Female O-Ring Face Seal Swivel
04	9/16-18
06	11/16-16
08	13/16-16
10	1-14
12	1 3/16-12
16	1 7/16-12
20	1 11/16-12
24	2-12

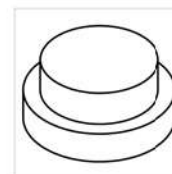

AVAILABILITY

» Steel

ORFS Cap

SHAPE

Cap

Dash Size	Female O-Ring Face Seal Swivel
04	9/16-18
06	11/16-16
08	13/16-16
10	1-14
12	1 3/16-12
16	1 7/16-12
20	1 11/16-12
24	2-12

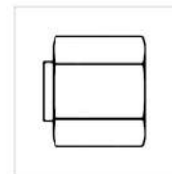

COMPLIANCE

» SAE 520112

AVAILABILITY

» Import Steel

» Steel

FF306

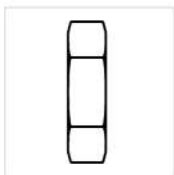

ORFS Bulkhead Locknut

To include locknut with bulkhead fitting add "LN" after base part number. Example FF2700-LN-04-04.

SHAPE

Nut

Dash Size	Female O-Ring Face Seal
04	9/16-18
06	11/16-16
08	13/16-16
10	1-14
12	1 3/16-12
16	1 7/16-12
20	1 11/16-12
24	2-12

AVAILABILITY

» Steel

COMPLIANCE

» SAE 520118

FF318

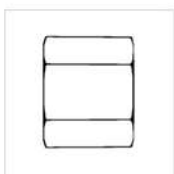

ORFS Tube Nut

SHAPE

Nut

Dash Size	Female O-Ring Face Seal Swivel
04	9/16-18
06	11/16-16
08	13/16-16
10	1-14
12	1 3/16-12
16	1 7/16-12
20	1 11/16-12
24	2-12

AVAILABILITY

» Steel

» Import Stainless Steel

COMPLIANCE

» SAE 520110

FF319

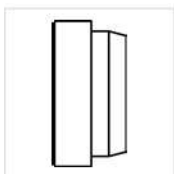

ORFS Braze-On Sleeve

Use with silver braze ring. Order SBR and size (e.g. SBR04).

SHAPE

Sleeve

Dash Size	Tube Size
04	1/4
06	3/8
08	1/2
10	5/8
12	3/4
16	1
20	1 1/4
24	1 1/2

AVAILABILITY

» Steel

» Import Stainless Steel

COMPLIANCE

» 520115

Braze-On to ORFS Connector

Use with silver braze ring. Order SBR and size (e.g. SBR04).

SHAPE

Straight

Dash Size	Braze Port	Male O-Ring Face Seal
04-04	1/4	9/16-18
06-04	3/8	9/16-18
06-06	3/8	11/16-16
08-06	1/2	11/16-16
08-08	1/2	13/16-16
10-06	5/8	11/16-16
10-08	5/8	13/16-16
10-10	5/8	1-14
12-08	3/4	13/16-16
12-12	3/4	1 3/16-12
16-12	1	1 3/16-12
16-16	1	1 7/16-12
20-16	1 1/4	1 7/16-12
20-20	1 1/4	1 11/16-12
24-20	1 1/2	1 11/16-12
24-24	1 1/2	2-12

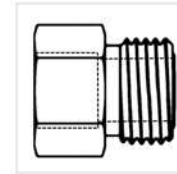

FF403

COMPLIANCE

» SAE 520104

AVAILABILITY

» Import Steel
» Steel

ORFS to O-Ring

SHAPE

Straight

Dash Size	Male O-Ring Face Seal	Male O-Ring
04-04	9/16-18	7/16-20
04-05	9/16-18	1/2-20
04-06	9/16-18	9/16-18
04-08	9/16-18	3/4-16
06-04	11/16-16	7/16-20
06-05	11/16-16	1/2-20
06-06	11/16-16	9/16-18
06-08	11/16-16	3/4-16
06-10	11/16-16	7/8-14
06-12	11/16-16	1 1/16-12
06-16	11/16-16	1 5/16-12
08-06	13/16-16	9/16-18
08-08	13/16-16	3/4-16
08-10	13/16-16	7/8-14
08-12	13/16-16	1 1/16-12
08-16	13/16-16	1 5/16-12
10-06	1-14	9/16-18
10-08	1-14	3/4-16
10-10	1-14	7/8-14
10-12	1-14	1 1/16-12
10-16	1-14	1 5/16-12
12-08	1 3/16-12	3/4-16
12-10	1 3/16-12	7/8-14
12-12	1 3/16-12	1 1/16-12
12-14	1 3/16-12	1 3/16-12
12-16	1 3/16-12	1 5/16-12
12-20	1 3/16-12	1 5/8-12
16-10	1 7/16-12	7/8-14

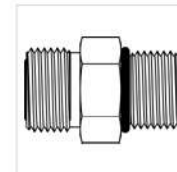

FF6400

COMPLIANCE

» SAE 520120

AVAILABILITY

» Import Steel
» Steel
» Import Stainless Steel

▼ FF6400 continues

FF6400
 ▼ continued

Dash Size	Male O-Ring Face Seal	Male O-Ring
16-12	1 7/16-12	1 1/16-12
16-16	1 7/16-12	1 5/16-12
16-20	1 7/16-12	1 5/8-12
16-24	1 7/16-12	1 7/8-12
20-16	1 11/16-12	1 5/16-12
20-20	1 11/16-12	1 5/8-12
20-24	1 11/16-12	1 7/8-12
24-20	2-12	1 5/8-12
24-24	2-12	1 7/8-12

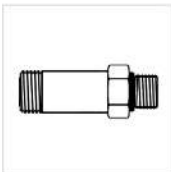
FF6400-L

ORFS to O-Ring - Long

SHAPE

Straight

Dash Size	Male O-Ring Face Seal	Male O-Ring	Overall Adapter Length (OAL)
04-04	9/16-18	7/16-20	2.07
06-06	11/16-16	9/16-18	2.27
06-08	11/16-16	3/4-16	2.14
08-08	13/16-16	3/4-16	2.67
10-08	1-14	3/4-16	3.00
10-10	1-14	7/8-14	3.13
12-12	1 3/16-12	1 1/16-12	3.76
16-16	1 7/16-12	1 5/16-12	4.14
20-20	1 11/16-12	1 5/8-12	4.76
24-24	2-12	1 7/8-12	5.26

AVAILABILITY

- » Import Steel
- » Steel

COMPLIANCE

- » SAE 520122

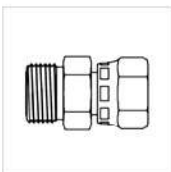
FF6402

ORFS to JIC Swivel

SHAPE

Straight

Dash Size	Male O-Ring Face Seal	Female JIC Swivel
04-04	9/16-18	7/16-20
06-06	11/16-16	9/16-18
08-08	13/16-16	3/4-16
10-10	1-14	7/8-14
12-12	1 3/16-12	1 1/16-12
16-16	1 7/16-12	1 5/16-12
20-20	1 11/16-12	1 5/8-12
24-24	2-12	1 7/8-12

AVAILABILITY

- » Import Steel
- » Steel

COMPLIANCE

- » SAE 520181

ORFS to ORFS Swivel Elbow 90°

SHAPE

90 degree elbow

Dash Size	Male O-Ring Face Seal	Female O-Ring Face Seal Swivel
04-04	9/16-18	9/16-18
04-06	9/16-18	11/16-16
06-06	11/16-16	11/16-16
08-06	13/16-16	11/16-16
08-08	13/16-16	13/16-16
08-12	13/16-16	1 3/16-12
10-10	1-14	1-14
12-12	1 3/16-12	1 3/16-12
16-16	1 7/16-12	1 7/16-12
20-20	1 11/16-12	1 11/16-12
24-20	2-12	1 11/16-12
24-24	2-12	2-12

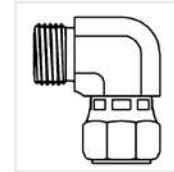

FF6500

COMPLIANCE

» SAE 520221

AVAILABILITY

» Import Steel
» Import Stainless Steel

ORFS to ORFS Swivel Elbow 45°

SHAPE

45 degree elbow

Dash Size	Male O-Ring Face Seal	Female O-Ring Face Seal Swivel
04-04	9/16-18	9/16-18
06-06	11/16-16	11/16-16
08-08	13/16-16	13/16-16
10-10	1-14	1-14
12-12	1 3/16-12	1 3/16-12
16-16	1 7/16-12	1 7/16-12
20-20	1 11/16-12	1 11/16-12

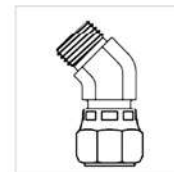

FF6502

AVAILABILITY

» Import Steel

JIC to ORFS Swivel

SHAPE

Straight

Dash Size	Male JIC	Female O-Ring Face Seal Swivel
04-04	7/16-20	9/16-18
06-06	9/16-18	11/16-16
06-08	9/16-18	13/16-16
08-08	3/4-16	13/16-16
10-10	7/8-14	1-14
12-12	1 1/16-12	1 3/16-12
16-16	1 5/16-12	1 7/16-12
20-20	1 5/8-12	1 11/16-12
24-24	1 7/8-12	2-12

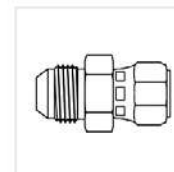

FF6504

AVAILABILITY

» Import Steel
» Steel

FF6505

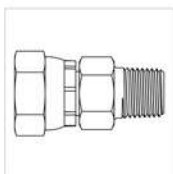

ORFS Swivel to Pipe

SHAPE Straight

Dash Size	Female O-Ring Face Seal Swivel	Male Pipe
04-04	9/16-18	1/4-18
06-06	11/16-16	3/8-18
08-08	13/16-16	1/2-14
10-08	1-14	1/2-14
12-12	1 3/16-12	3/4-14
16-16	1 7/16-12	1-11 1/2

AVAILABILITY

- » Import Steel
- » Steel

FF6507

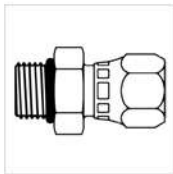

O-Ring to ORFS Swivel

SHAPE Straight

Dash Size	Male British Pipe Parallel	Female O-Ring Face Seal Swivel
04-04	1/4-19	9/16-18
06-06	3/8-19	11/16-16
08-08	1/2-14	13/16-16
10-10	5/8-14	1-14
12-12	3/4-14	1 3/16-12
16-16	1-11	1 7/16-12
20-20	1 1/4-11	1 11/16-12

AVAILABILITY

- » Import Steel
- » Steel

FF6510

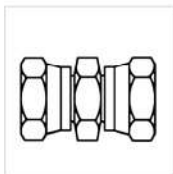

ORFS Swivel to ORFS Swivel

SHAPE Straight

Dash Size	Female O-Ring Face Seal Swivel	Female O-Ring Face Seal Swivel
04-04	9/16-18	9/16-18
06-06	11/16-16	11/16-16
08-08	13/16-16	13/16-16
12-12	1 3/16-12	1 3/16-12
16-16	1 7/16-12	1 7/16-12

AVAILABILITY

- » Steel

FF6600

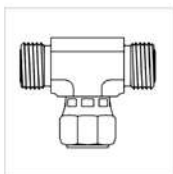

ORFS to ORFS Swivel Branch Tee

SHAPE Tee

Dash Size	Male O-Ring Face Seal	Male O-Ring Face Seal	Female O-Ring Face Seal Swivel
04-04-04	9/16-18	9/16-18	9/16-18
06-06-06	11/16-16	11/16-16	11/16-16
08-08-08	13/16-16	13/16-16	13/16-16
10-10-10	1-14	1-14	1-14
12-12-12	1 3/16-12	1 3/16-12	1 3/16-12
16-16-16	1 7/16-12	1 7/16-12	1 7/16-12
20-20-20	1 11/16-12	1 11/16-12	1 11/16-12
24-24-24	2-12	2-12	2-12

AVAILABILITY

- » Import Steel

COMPLIANCE

- » SAE 520433

ORFS to ORFS Swivel Run Tee

SHAPE

Tee

Dash Size	Male O-Ring Face Seal	Female O-Ring Face Seal Swivel	Male O-Ring Face Seal
04-04-04	9/16-18	9/16-18	9/16-18
06-06-06	11/16-16	11/16-16	11/16-16
08-08-08	13/16-16	13/16-16	13/16-16
10-10-10	1-14	1-14	1-14
12-12-12	1 3/16-12	1 3/16-12	1 3/16-12
16-16-16	1 7/16-12	1 7/16-12	1 7/16-12
20-20-20	1 11/16-12	1 11/16-12	1 11/16-12
24-24-24	2-12	2-12	2-12

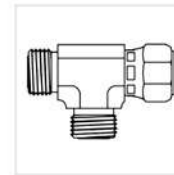

FF6602

COMPLIANCE
» SAE 520432

AVAILABILITY
» Import Steel

ORFS to O-Ring Elbow 90°

SHAPE

90 degree elbow

Dash Size	Male O-Ring Face Seal	Male O-Ring
04-04	9/16-18	7/16-20
04-05	9/16-18	1/2-20
04-06	9/16-18	9/16-18
04-08	9/16-18	3/4-16
06-04	11/16-16	7/16-20
06-05	11/16-16	1/2-20
06-06	11/16-16	9/16-18
06-08	11/16-16	3/4-16
06-10	11/16-16	7/8-14
06-12	11/16-16	1 1/16-12
06-16	11/16-16	1 5/16-12
08-06	13/16-16	9/16-18
08-08	13/16-16	3/4-16
08-10	13/16-16	7/8-14
08-12	13/16-16	1 1/16-12
10-08	1-14	3/4-16
10-10	1-14	7/8-14
10-12	1-14	1 1/16-12
12-08	1 3/16-12	3/4-16
12-10	1 3/16-12	7/8-14
12-12	1 3/16-12	1 1/16-12
12-16	1 3/16-12	1 5/16-12
16-12	1 7/16-12	1 1/16-12
16-14	1 7/16-12	1 3/16-12
16-16	1 7/16-12	1 5/16-12
16-20	1 7/16-12	1 5/8-12
20-12	1 11/16-12	1 1/16-12
20-16	1 11/16-12	1 5/16-12
20-20	1 11/16-12	1 5/8-12
20-24	1 11/16-12	1 7/8-12
24-20	2-12	1 5/8-12
24-24	2-12	1 7/8-12

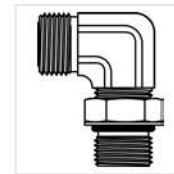

FF6801

COMPLIANCE
» SAE 520220

AVAILABILITY
» Import Steel
» Import Stainless Steel

FF6801-L



ORFS to O-Ring Elbow 90° - Long

Drop Length = Middle of Male O-Ring Face Seal to End of Male O-Ring Threads.

SHAPE

90 degree elbow

Dash Size	Male O-Ring Face Seal	Male O-Ring	Drop Length
12-12	1 3/16-12	1 1/16-12	3.31

AVAILABILITY

» Import Steel

FF6801-LL



ORFS to O-Ring Elbow 90° - Extra Long

Drop Length = Middle of Male O-Ring Face Seal to End of Male O-Ring Threads.

SHAPE

90 degree elbow

Dash Size	Male O-Ring Face Seal	Male O-Ring	Drop Length
04-04	9/16-18	7/16-20	2.23
06-06	11/16-16	9/16-18	2.61
08-08	13/16-16	3/4-16	2.95
10-10	1-14	7/8-14	3.51
12-12	1 3/16-12	1 1/16-12	3.97
16-16	1 7/16-12	1 5/16-12	4.51
20-20	1 11/16-12	1 5/8-12	4.98
24-24	2-12	1 7/8-12	5.48

AVAILABILITY

» Import Steel

FF6801-LLL



ORFS to O-Ring Elbow 90° - Extra Extra Long

Drop Length = Middle of Male O-Ring Face Seal to End of Male O-Ring Threads.

SHAPE

90 degree elbow

Dash Size	Male O-Ring Face Seal	Male O-Ring	Drop Length
08-08	13/16-16	3/4-16	3.50
16-16	1 7/16-12	1 5/16-12	5.00

AVAILABILITY

» Import Steel

FF6802

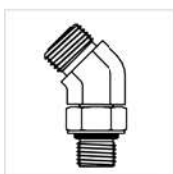

ORFS to O-Ring Elbow 45°

SHAPE

45 degree elbow

Dash Size	Male O-Ring Face Seal	Male O-Ring
04-04	9/16-18	7/16-20
04-06	9/16-18	9/16-18
06-04	11/16-16	7/16-20
06-06	11/16-16	9/16-18
06-08	11/16-16	3/4-16
06-10	11/16-16	7/8-14
08-06	13/16-16	9/16-18
08-08	13/16-16	3/4-16
08-10	13/16-16	7/8-14
08-12	13/16-16	1 1/16-12
10-08	1-14	3/4-16
10-10	1-14	7/8-14
10-12	1-14	1 1/16-12
12-08	1 3/16-12	3/4-16
12-10	1 3/16-12	7/8-14
12-12	1 3/16-12	1 1/16-12

AVAILABILITY

» Import Steel

COMPLIANCE

» SAE 520320

Dash Size	Male O-Ring Face Seal	Male O-Ring
12-16	1 3/16-12	1 5/16-12
16-12	1 7/16-12	1 1/16-12
16-16	1 7/16-12	1 5/16-12
16-20	1 7/16-12	1 5/8-12
20-20	1 11/16-12	1 5/8-12
24-24	2-12	1 7/8-12

FF6802
▼ continued

ORFS to O-Ring Branch Tee

SHAPE

Tee

Dash Size	Male O-Ring Face Seal	Male O-Ring Face Seal	Male O-Ring
04-04-04	9/16-18	9/16-18	7/16-20
04-04-06	9/16-18	9/16-18	9/16-18
06-06-06	11/16-16	11/16-16	9/16-18
06-06-08	11/16-16	11/16-16	3/4-16
08-06-08	13/16-16	11/16-16	3/4-16
08-08-06	13/16-16	13/16-16	9/16-18
08-08-08	13/16-16	13/16-16	3/4-16
10-10-10	1-14	1-14	7/8-14
12-12-10	1 3/16-12	1 3/16-12	7/8-14
12-12-12	1 3/16-12	1 3/16-12	1 1/16-12
12-12-16	1 3/16-12	1 3/16-12	1 5/16-12
12-16-16	1 3/16-12	1 7/16-12	1 5/16-12
16-16-12	1 7/16-12	1 7/16-12	1 1/16-12
16-16-16	1 7/16-12	1 7/16-12	1 5/16-12
20-20-16	1 11/16-12	1 11/16-12	1 5/16-12
20-20-20	1 11/16-12	1 11/16-12	1 5/8-12
24-24-24	2-12	2-12	1 7/8-12

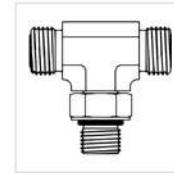

FF6803

COMPLIANCE
» SAE 520429

AVAILABILITY
» Import Steel

ORFS to O-Ring Run Tee

SHAPE

Tee

Dash Size	Male O-Ring Face Seal	Male O-Ring	Male O-Ring Face Seal
04-04-04	9/16-18	7/16-20	9/16-18
04-06-04	9/16-18	9/16-18	9/16-18
06-04-06	11/16-16	7/16-20	11/16-16
06-06-06	11/16-16	9/16-18	11/16-16
08-06-08	13/16-16	9/16-18	13/16-16
08-08-08	13/16-16	3/4-16	13/16-16
08-10-08	13/16-16	7/8-14	13/16-16
08-12-08	13/16-16	1 1/16-12	13/16-16
10-10-10	1-14	7/8-14	1-14
10-12-10	1-14	1 1/16-12	1-14
10-12-12	1-14	1 1/16-12	1 3/16-12
12-12-12	1 3/16-12	1 1/16-12	1 3/16-12
12-16-12	1 3/16-12	1 5/16-12	1 3/16-12
16-12-16	1 7/16-12	1 1/16-12	1 7/16-12
16-16-12	1 7/16-12	1 5/16-12	1 3/16-12
16-16-16	1 7/16-12	1 5/16-12	1 7/16-12
20-16-20	1 11/16-12	1 5/16-12	1 11/16-12
20-20-20	1 11/16-12	1 5/8-12	1 11/16-12
24-24-24	2-12	1 7/8-12	2-12

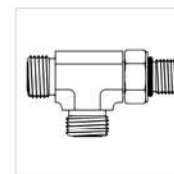

FF6804

COMPLIANCE
» SAE 520428

AVAILABILITY
» Import Steel

FF6809

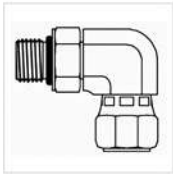

O-Ring to ORFS Swivel Elbow 90°

SHAPE

90 degree elbow

Dash Size	Male O-Ring	Female O-Ring Face Seal Swivel
04-04	7/16-20	9/16-18
06-06	9/16-18	11/16-16
08-08	3/4-16	13/16-16
10-10	7/8-14	1-14
12-12	1 1/16-12	1 3/16-12
16-16	1 5/16-12	1 7/16-12
20-20	1 5/8-12	1 11/16-12
24-24	1 7/8-12	2-12

AVAILABILITY

» Import Steel

75DFF-Viton

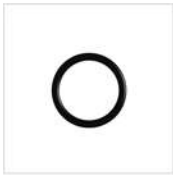

Viton 75 Durometer Face Seal O-Ring

Please note: Viton is a registered trademark of DuPont Dow Elastomers. Visit their site for more information.

SHAPE

O-Ring

Dash Size
04
06
08
10
12
16
20
24

AVAILABILITY

» Viton 75 Durometer

90DFF



Buna-Nitrile 90 Durometer Face Seal O-Ring

SHAPE

O-Ring

Dash Size
04
06
08
10
12
16
20
24

AVAILABILITY

» Buna-Nitrile 90 Durometer

Beaded Hose Fittings

Beaded Hose to Pipe

SHAPE

Straight

Dash Size	Beaded Stem	Male Pipe
04-02	1/4	1/8-27
04-04	1/4	1/4-18
05-02	5/16	1/8-27
06-04	3/8	1/4-18
06-06	3/8	3/8-18
08-04	1/2	1/4-18
08-06	1/2	3/8-18
08-08	1/2	1/2-14
08-12	1/2	3/4-14
10-06	5/8	3/8-18
10-08	5/8	1/2-14
10-12	5/8	3/4-14
12-08	3/4	1/2-14
12-12	3/4	3/4-14
12-16	3/4	1-11 1/2
16-12	1	3/4-14
16-16	1	1-11 1/2
20-16	1 1/4	1-11 1/2
20-20	1 1/4	1 1/4-11 1/2
20-24	1 1/4	1 1/2-11 1/2
24-20	1 1/2	1 1/4-11 1/2
24-24	1 1/2	1 1/2-11 1/2
32-32	2	2-11 1/2
40-40	2 1/2	2 1/2-8

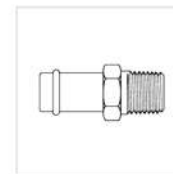

4404

COMPLIANCE
» SAE 430160

AVAILABILITY
» Import Steel
» Steel

Hose Barb to Pipe

SHAPE

Straight

Dash Size	Hose Barb	Male Pipe
04-02	1/4	1/8-27
04-04	1/4	1/4-18
04-06	1/4	3/8-18
05-04	5/16	1/4-18
06-02	3/8	1/8-27
06-04	3/8	1/4-18
06-06	3/8	3/8-18
06-08	3/8	1/2-14
08-04	1/2	1/4-18
08-06	1/2	3/8-18
08-08	1/2	1/2-14
10-08	5/8	1/2-14
10-12	5/8	3/4-14
12-08	3/4	1/2-14
12-12	3/4	3/4-14
12-16	3/4	1-11 1/2

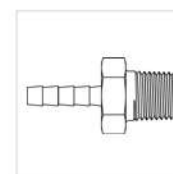

4444

AVAILABILITY
» Import Steel
» Steel

▼ 4444 continues

4444
▼ continued

Dash Size	Hose Barb	Male Pipe
16-12	1	3/4-14
16-16	1	1-11 1/2
20-20	1 1/4	1 1/4-11 1/2
24-24	1 1/2	1 1/2-11 1/2
32-32	2	2-11 1/2

4445

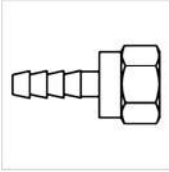

Hose Barb to JIC Swivel

SHAPE

Straight

Dash Size	Hose Barb	Female JIC Swivel
12-12	3/4	1 1/16-12
12-16	3/4	1 5/16-12
16-16	1	1 5/16-12
20-20	1 1/4	1 5/8-12
24-24	1 1/2	1 7/8-12
32-32	2	2 1/2-12
40-40	2 1/2	3-12
48-48	3	3 1/2-12

AVAILABILITY

- » Import Steel
- » Steel

4501

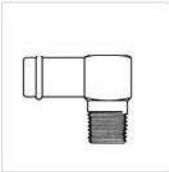

Beaded Hose to Pipe Elbow 90°

SHAPE

90 degree elbow

Dash Size	Beaded Stem	Male Pipe
04-02	1/4	1/8-27
04-04	1/4	1/4-18
05-02	5/16	1/8-27
05-04	5/16	1/4-18
06-04	3/8	1/4-18
06-06	3/8	3/8-18
08-06	1/2	3/8-18
08-08	1/2	1/2-14
08-12	1/2	3/4-14
10-06	5/8	3/8-18
10-08	5/8	1/2-14
12-08	3/4	1/2-14
12-12	3/4	3/4-14
12-16	3/4	1-11 1/2
16-12	1	3/4-14
16-16	1	1-11 1/2
20-16	1 1/4	1-11 1/2
20-20	1 1/4	1 1/4-11 1/2
20-24	1 1/4	1 1/2-11 1/2
24-20	1 1/2	1 1/4-11 1/2
24-24	1 1/2	1 1/2-11 1/2
32-32	2	2-11 1/2

AVAILABILITY

- » Import Steel
- » Steel

COMPLIANCE

- » SAE 430260

Beaded Hose to Pipe Elbow 45°

SHAPE

45 degree elbow

Dash Size	Beaded Stem	Male Pipe
04-02	1/4	1/8-27
04-04	1/4	1/4-18
06-04	3/8	1/4-18
06-06	3/8	3/8-18
08-06	1/2	3/8-18
08-08	1/2	1/2-14
10-08	5/8	1/2-14
12-08	3/4	1/2-14
12-12	3/4	3/4-14
16-12	1	3/4-14
16-16	1	1-11 1/2
16-20	1	1 1/4-11 1/2
20-16	1 1/4	1-11 1/2
20-20	1 1/4	1 1/4-11 1/2
24-24	1 1/2	1 1/2-11 1/2
32-32	2	2-11 1/2

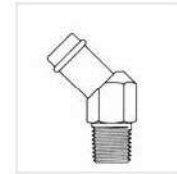
**4503****COMPLIANCE**

» SAE 430360

AVAILABILITY» Import Steel
» Steel**Beaded Hose to O-Ring Elbow 90°**

SHAPE

90 degree elbow

Dash Size	Beaded Stem	Male O-Ring
04-04	1/4	7/16-20
05-04	5/16	7/16-20
05-05	5/16	1/2-20
06-04	3/8	7/16-20
06-06	3/8	9/16-18
06-08	3/8	3/4-16
08-06	1/2	9/16-18
08-08	1/2	3/4-16
08-10	1/2	7/8-14
10-08	5/8	3/4-16
10-10	5/8	7/8-14
10-12	5/8	1 1/16-12
12-08	3/4	3/4-16
12-10	3/4	7/8-14
12-12	3/4	1 1/16-12
12-16	3/4	1 5/16-12
16-12	1	1 1/16-12
16-16	1	1 5/16-12
16-20	1	1 5/8-12
20-12	1 1/4	1 1/16-12
20-16	1 1/4	1 5/16-12
20-20	1 1/4	1 5/8-12
20-24	1 1/4	1 7/8-12
24-20	1 1/2	1 5/8-12
24-24	1 1/2	1 7/8-12
32-20	2	1 5/8-12
32-24	2	1 7/8-12
32-32	2	2 1/2-12

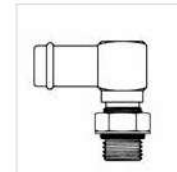
**4601****AVAILABILITY**» Import Steel
» Steel

4603

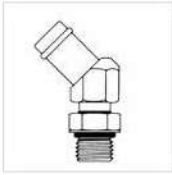

Beaded Hose to O-Ring Elbow 45°

SHAPE

45 degree elbow

Dash Size	Beaded Stem	Male O-Ring
04-04	1/4	7/16-20
04-06	1/4	9/16-18
06-06	3/8	9/16-18
08-06	1/2	9/16-18
08-08	1/2	3/4-16
10-08	5/8	3/4-16
10-10	5/8	7/8-14
10-12	5/8	1 1/16-12
12-08	3/4	3/4-16
12-10	3/4	7/8-14
12-12	3/4	1 1/16-12
12-16	3/4	1 5/16-12
16-12	1	1 1/16-12
16-16	1	1 5/16-12
20-16	1 1/4	1 5/16-12
20-20	1 1/4	1 5/8-12
24-16	1 1/2	1 5/16-12
24-20	1 1/2	1 5/8-12
24-24	1 1/2	1 7/8-12
32-32	2	2 1/2-12

AVAILABILITY

- » Import Steel
- » Steel

4604



Beaded Hose to O-Ring

SHAPE

Straight

Dash Size	Beaded Stem	Male O-Ring
04-04	1/4	7/16-20
05-05	5/16	1/2-20
06-04	3/8	7/16-20
06-06	3/8	9/16-18
06-08	3/8	3/4-16
06-10	3/8	7/8-14
08-06	1/2	9/16-18
08-08	1/2	3/4-16
08-10	1/2	7/8-14
10-08	5/8	3/4-16
10-10	5/8	7/8-14
12-08	3/4	3/4-16
12-10	3/4	7/8-14
12-12	3/4	1 1/16-12
16-12	1	1 1/16-12
16-16	1	1 5/16-12
16-20	1	1 5/8-12
20-14	1 1/4	1 3/16-12
20-16	1 1/4	1 5/16-12
20-20	1 1/4	1 5/8-12
20-24	1 1/4	1 7/8-12
24-20	1 1/2	1 5/8-12
24-24	1 1/2	1 7/8-12
32-20	2	1 5/8-12
32-24	2	1 7/8-12
32-32	2	2 1/2-12

AVAILABILITY

- » Import Steel
- » Steel



FLANGES & FLANGE ADAPTERS

JIC Flange Adapters

6840

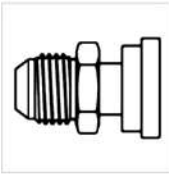

JIC to Flange - Code 61

6840-10-10 and 6840-12-10 are Komatsu fittings.

SHAPE

Straight

AVAILABILITY

» Steel

COMPLIANCE

» Code 61

Dash Size	Male JIC	Code 61 Flange
08-08	3/4-16	1/2"
08-12	3/4-16	3/4"
10-10	7/8-14	16mm
10-16	7/8-14	1"
12-10	1 1/16-12	16mm
12-12	1 1/16-12	3/4"
12-16	1 1/16-12	1"
12-20	1 1/16-12	1 1/4"
16-12	1 5/16-12	3/4"
16-16	1 5/16-12	1"
16-20	1 5/16-12	1 1/4"
16-24	1 5/16-12	1 1/2"
20-16	1 5/8-12	1"
20-20	1 5/8-12	1 1/4"
20-24	1 5/8-12	1 1/2"
20-32	1 5/8-12	2"
24-20	1 7/8-12	1 1/4"
24-24	1 7/8-12	1 1/2"
24-32	1 7/8-12	2"
32-24	2 1/2-12	1 1/2"
32-32	2 1/2-12	2"
32-40	2 1/2-12	2 1/2"
40-40	3-12	2 1/2"

6842

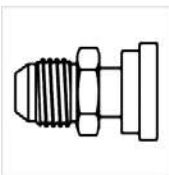

JIC to Flange - Code 62

SHAPE

Straight

AVAILABILITY

» Steel

COMPLIANCE

» Code 62

Dash Size	Male JIC	Code 62 Flange
08-08	3/4-16	1/2"
12-12	1 1/16-12	3/4"
12-16	1 1/16-12	1"
16-12	1 5/16-12	3/4"
16-16	1 5/16-12	1"
16-20	1 5/16-12	1 1/4"
16-24	1 5/16-12	1 1/2"
20-16	1 5/8-12	1"
20-20	1 5/8-12	1 1/4"
20-24	1 5/8-12	1 1/2"
24-20	1 7/8-12	1 1/4"
24-24	1 7/8-12	1 1/2"
24-32	1 7/8-12	2"
32-24	2 1/2-12	1 1/2"
32-32	2 1/2-12	2"

JIC to Flange Elbow 45° - Code 61

SHAPE

45 degree elbow

Dash Size	Male JIC	Code 61 Flange
08-08	3/4-16	1/2"
08-12	3/4-16	3/4"
12-12	1 1/16-12	3/4"
12-16	1 1/16-12	1"
12-20	1 1/16-12	1 1/4"
16-16	1 5/16-12	1"
16-20	1 5/16-12	1 1/4"
16-24	1 5/16-12	1 1/2"
20-16	1 5/8-12	1"
20-20	1 5/8-12	1 1/4"
20-24	1 5/8-12	1 1/2"
20-32	1 5/8-12	2"
24-24	1 7/8-12	1 1/2"
32-32	2 1/2-12	2"



6845

COMPLIANCE

» Code 61

AVAILABILITY

» Import Steel
» Steel

JIC to Flange Elbow 45° - Code 62

SHAPE

45 degree elbow

Dash Size	Male JIC	Code 62 Flange
12-12	1 1/16-12	3/4"
12-16	1 1/16-12	1"
16-16	1 5/16-12	1"
16-20	1 5/16-12	1 1/4"
16-24	1 5/16-12	1 1/2"
20-12	1 5/8-12	3/4"
20-16	1 5/8-12	1"
20-20	1 5/8-12	1 1/4"
20-24	1 5/8-12	1 1/2"
24-20	1 7/8-12	1 1/4"
24-24	1 7/8-12	1 1/2"
32-32	2 1/2-12	2"



6847

COMPLIANCE

» Code 62

AVAILABILITY

» Import Steel
» Steel

6890



AVAILABILITY

- » Import Steel
- » Steel

COMPLIANCE

- » Code 61

JIC to Flange Elbow 90° - Code 61

6890-12-10 is a Komatsu fitting.

SHAPE

90 degree elbow

Dash Size	Male JIC	Code 61 Flange
08-08	3/4-16	1/2"
08-12	3/4-16	3/4"
10-16	7/8-14	1"
12-10	1 1/16-12	16mm
12-12	1 1/16-12	3/4"
12-16	1 1/16-12	1"
12-20	1 1/16-12	1 1/4"
12-24	1 1/16-12	1 1/2"
16-12	1 5/16-12	3/4"
16-16	1 5/16-12	1"
16-20	1 5/16-12	1 1/4"
16-24	1 5/16-12	1 1/2"
20-16	1 5/8-12	1"
20-20	1 5/8-12	1 1/4"
20-24	1 5/8-12	1 1/2"
20-32	1 5/8-12	2"
24-20	1 7/8-12	1 1/4"
24-24	1 7/8-12	1 1/2"
24-32	1 7/8-12	2"
32-24	2 1/2-12	1 1/2"
32-32	2 1/2-12	2"
32-40	2 1/2-12	2 1/2"
40-40	3-12	2 1/2"

6892



AVAILABILITY

- » Import Steel
- » Steel

COMPLIANCE

- » Code 62

JIC to Flange Elbow 90° - Code 62

SHAPE

90 degree elbow

Dash Size	Male JIC	Code 62 Flange
08-08	3/4-16	1/2"
12-08	1 1/16-12	1/2"
12-12	1 1/16-12	3/4"
12-16	1 1/16-12	1"
12-20	1 1/16-12	1 1/4"
16-12	1 5/16-12	3/4"
16-16	1 5/16-12	1"
16-20	1 5/16-12	1 1/4"
16-24	1 5/16-12	1 1/2"
20-16	1 5/8-12	1"
20-20	1 5/8-12	1 1/4"
20-24	1 5/8-12	1 1/2"
24-16	1 7/8-12	1"
24-20	1 7/8-12	1 1/4"
24-24	1 7/8-12	1 1/2"
24-32	1 7/8-12	2"
32-24	2 1/2-12	1 1/2"
32-32	2 1/2-12	2"

O-Ring Face Seal Flange

ORFS to Flange Straight - Code 61

SHAPE

Straight

Dash Size	Male O-Ring Face Seal	Code 61 Flange
12-12	1 3/16-12	3/4"
12-16	1 3/16-12	1"
16-12	1 7/16-12	3/4"
16-16	1 7/16-12	1"
16-20	1 7/16-12	1 1/4"
20-16	1 11/16-12	1"
20-20	1 11/16-12	1 1/4"
20-24	1 11/16-12	1 1/2"
24-20	2-12	1 1/4"
24-24	2-12	1 1/2"
24-32	2-12	2"

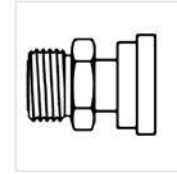

FF6840

COMPLIANCE

» Code 61

AVAILABILITY

» Steel

ORFS to Flange Straight - Code 62

SHAPE

Straight

Dash Size	Male O-Ring Face Seal	Code 62 Flange
12-12	1 3/16-12	3/4"
12-16	1 3/16-12	1"
16-12	1 7/16-12	3/4"
16-16	1 7/16-12	1"
16-20	1 7/16-12	1 1/4"
20-16	1 11/16-12	1"
20-20	1 11/16-12	1 1/4"
20-24	1 11/16-12	1 1/2"
24-20	2-12	1 1/4"
24-24	2-12	1 1/2"
24-32	2-12	2"

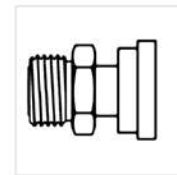

FF6842

COMPLIANCE

» Code 62

AVAILABILITY

» Steel

ORFS to Flange - 45°- CODE 61

SHAPE

45 degree elbow

Dash Size	Male O-Ring Face Seal	Code 61 Flange
12-12	1 3/16-12	3/4"
16-16	1 7/16-12	1"
20-20	1 11/16-12	1 1/4"
24-24	2-12	1 1/2"



FGFF6845

COMPLIANCE

» Code 61

AVAILABILITY

» Import Steel

FGFF6847



ORFS to Flange - 45°- CODE 62

SHAPE

45 degree elbow

AVAILABILITY

» Import Steel

COMPLIANCE

» Code 62

Dash Size	Male O-Ring Face Seal	Code 62 Flange
12-12	1 3/16-12	3/4"
16-16	1 7/16-12	1"
20-20	1 11/16-12	1 1/4"
24-24	2-12	1 1/2"

FGFF6890

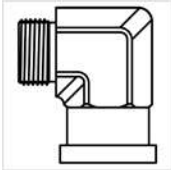

ORFS to Flange - 90°- CODE 61

SHAPE

90 degree elbow

AVAILABILITY

» Import Steel

COMPLIANCE

» Code 61

Dash Size	Male O-Ring Face Seal	Code 61 Flange
12-12	1 3/16-12	3/4"
12-16	1 3/16-12	1"
16-12	1 7/16-12	3/4"
16-16	1 7/16-12	1"
16-20	1 7/16-12	1 1/4"
20-16	1 11/16-12	1"
20-20	1 11/16-12	1 1/4"
20-24	1 11/16-12	1 1/2"
24-20	2-12	1 1/4"
24-24	2-12	1 1/2"
24-32	2-12	2"

FGFF6892

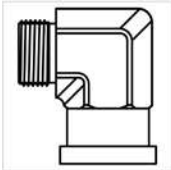

ORFS to Flange Elbow 90° - Code 62

SHAPE

90 degree elbow

AVAILABILITY

» Import Steel

COMPLIANCE

» Code 62

Dash Size	Male O-Ring Face Seal	Code 62 Flange
12-12	1 3/16-12	3/4"
12-16	1 3/16-12	1"
16-12	1 7/16-12	3/4"
16-16	1 7/16-12	1"
16-20	1 7/16-12	1 1/4"
20-16	1 11/16-12	1"
20-20	1 11/16-12	1 1/4"
20-24	1 11/16-12	1 1/2"
24-20	2-12	1 1/4"
24-24	2-12	1 1/2"

No Braze Flange Adapters

JIC to No Braze Flange Straight - Code 61

One-Piece Construction

SHAPE

Straight

Dash Size	Male JIC	Code 61 Flange
08-08	3/4-16	1/2"
08-12	3/4-16	3/4"
12-12	1 1/16-12	3/4"
12-16	1 1/16-12	1"
12-20	1 1/16-12	1 1/4"
14-12	1 3/16-12	3/4"
16-12	1 5/16-12	3/4"
16-16	1 5/16-12	1"
16-20	1 5/16-12	1 1/4"
16-24	1 5/16-12	1 1/2"
20-16	1 5/8-12	1"
20-20	1 5/8-12	1 1/4"
20-24	1 5/8-12	1 1/2"
20-32	1 5/8-12	2"
24-20	1 7/8-12	1 1/4"
24-24	1 7/8-12	1 1/2"
24-32	1 7/8-12	2"
32-24	2 1/2-12	1 1/2"
32-32	2 1/2-12	2"

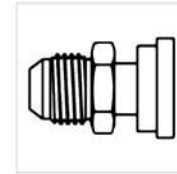

NB6840

COMPLIANCE

» Code 61

AVAILABILITY

» Import Steel

JIC to No Braze Flange Straight - Code 62

One-Piece Construction

SHAPE

Straight

Dash Size	Male JIC	Code 62 Flange
08-08	3/4-16	1/2"
12-12	1 1/16-12	3/4"
12-16	1 1/16-12	1"
16-12	1 5/16-12	3/4"
16-16	1 5/16-12	1"
16-20	1 5/16-12	1 1/4"
16-24	1 5/16-12	1 1/2"
20-16	1 5/8-12	1"
20-20	1 5/8-12	1 1/4"
20-24	1 5/8-12	1 1/2"
24-20	1 7/8-12	1 1/4"
24-24	1 7/8-12	1 1/2"
32-32	2 1/2-12	2"

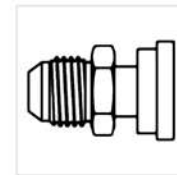

NB6842

COMPLIANCE

» Code 62

AVAILABILITY

» Import Steel



JIC to No Braze Flange Elbow 45° - Code 61

One-Piece Construction. NB6845-10-10 is a Komatsu fitting.

SHAPE

45 degree elbow

Dash Size	Male JIC	Code 61 Flange
08-08	3/4-16	1/2"
08-12	3/4-16	3/4"
10-10	7/8-14	16mm
12-12	1 1/16-12	3/4"
12-16	1 1/16-12	1"
12-20	1 1/16-12	1 1/4"
16-16	1 5/16-12	1"
16-20	1 5/16-12	1 1/4"
16-24	1 5/16-12	1 1/2"
20-12	1 5/8-12	3/4"
20-16	1 5/8-12	1"
20-20	1 5/8-12	1 1/4"
20-24	1 5/8-12	1 1/2"
24-20	1 7/8-12	1 1/4"
24-24	1 7/8-12	1 1/2"
24-32	1 7/8-12	2"
24-40	1 7/8-12	2 1/2"
32-24	2 1/2-12	1 1/2"
32-32	2 1/2-12	2"

AVAILABILITY

» Import Steel

COMPLIANCE

» Code 61



JIC to No Braze Flange Elbow 45° - Code 62

One-Piece Construction

SHAPE

45 degree elbow

Dash Size	Male JIC	Code 62 Flange
12-12	1 1/16-12	3/4"
12-16	1 1/16-12	1"
16-12	1 5/16-12	3/4"
16-16	1 5/16-12	1"
16-20	1 5/16-12	1 1/4"
16-24	1 5/16-12	1 1/2"
20-16	1 5/8-12	1"
20-20	1 5/8-12	1 1/4"
20-24	1 5/8-12	1 1/2"
24-24	1 7/8-12	1 1/2"
32-32	2 1/2-12	2"

AVAILABILITY

» Import Steel

COMPLIANCE

» Code 62

JIC to No Braze Flange Elbow 90 degree - Code 61

One-Piece Construction. NB6890-10-10 is a Komatsu fitting.

SHAPE

90 degree elbow

Dash Size	Male JIC	Code 61 Flange
08-08	3/4-16	1/2"
08-12	3/4-16	3/4"
10-10	7/8-14	16mm
12-12	1 1/16-12	3/4"
12-16	1 1/16-12	1"
12-20	1 1/16-12	1 1/4"
16-12	1 5/16-12	3/4"
16-16	1 5/16-12	1"
16-20	1 5/16-12	1 1/4"
16-24	1 5/16-12	1 1/2"
16-32	1 5/16-12	2"
20-16	1 5/8-12	1"
20-20	1 5/8-12	1 1/4"
20-24	1 5/8-12	1 1/2"
24-16	1 7/8-12	1"
24-20	1 7/8-12	1 1/4"
24-24	1 7/8-12	1 1/2"
24-32	1 7/8-12	2"
24-40	1 7/8-12	2 1/2"
32-24	2 1/2-12	1 1/2"
32-32	2 1/2-12	2"
32-40	2 1/2-12	2 1/2"
40-40	3-12	2 1/2"

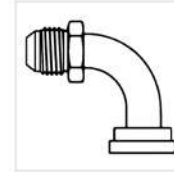
**NB6890****COMPLIANCE**

» Code 61

AVAILABILITY

» Import Steel

JIC to No Braze Flange Elbow 90 degree - Code 62

One-Piece Construction

SHAPE

90 degree elbow

Dash Size	Male JIC	Code 62 Flange
08-08	3/4-16	1/2"
12-12	1 1/16-12	3/4"
12-16	1 1/16-12	1"
12-20	1 1/16-12	1 1/4"
16-12	1 5/16-12	3/4"
16-16	1 5/16-12	1"
16-20	1 5/16-12	1 1/4"
16-24	1 5/16-12	1 1/2"
20-16	1 5/8-12	1"
20-20	1 5/8-12	1 1/4"
20-24	1 5/8-12	1 1/2"
24-20	1 7/8-12	1 1/4"
24-24	1 7/8-12	1 1/2"
24-32	1 7/8-12	2"
32-32	2 1/2-12	2"

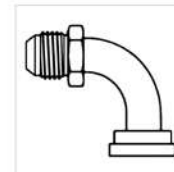
**NB6892****COMPLIANCE**

» Code 62

AVAILABILITY

» Import Steel

NBFF6842

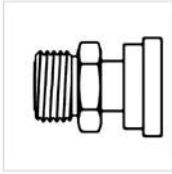

ORFS to No Braze Flange Straight - Code 62

One-Piece Construction

SHAPE

Straight

Dash Size	Male O-Ring Face Seal	Code 62 Flange
12-12	1 3/16-12	3/4"
16-12	1 7/16-12	3/4"

AVAILABILITY

» Import Steel

COMPLIANCE

» Code 62

NBFF6847



ORFS to No Braze Flange 45° - Code 62

One-Piece Construction

SHAPE

45 degree elbow

Dash Size	Male O-Ring Face Seal	Code 62 Flange
12-12	1 3/16-12	3/4"
16-12	1 7/16-12	3/4"
20-12	1 11/16-12	3/4"

AVAILABILITY

» Import Steel

COMPLIANCE

» Code 62

NBFF6890



ORFS to No Braze Flange 90° - Code 61

One-Piece Construction

SHAPE

90 degree elbow

Dash Size	Male O-Ring Face Seal	Code 61 Flange
16-16	1 7/16-12	1"
20-20	1 11/16-12	1 1/4"

AVAILABILITY

» Import Steel

COMPLIANCE

» Code 61

NBFF6892

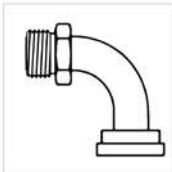

ORFS to No Braze Flange 90° - Code 62

One-Piece Construction

SHAPE

90 degree elbow

Dash Size	Male O-Ring Face Seal	Code 62 Flange
12-12	1 3/16-12	3/4"
16-12	1 7/16-12	3/4"

AVAILABILITY

» Import Steel

COMPLIANCE

» Code 62

Code 61 Flange Components

Braze to Split Flange - Code 61

SHAPE

Straight

Dash Size	Braze Port	Code 61 Flange
08-08	1/2	1/2"
12-12	3/4	3/4"
16-16	1	1"
16-20	1	1 1/4"
20-16	1 1/4	1"
20-20	1 1/4	1 1/4"
20-24	1 1/4	1 1/2"
24-24	1 1/2	1 1/2"
32-32	2	2"
32-40	2	2 1/2"
40-40	2 1/2	2 1/2"
48-48	3	3"



COMPLIANCE
» Code 61

AVAILABILITY
» Steel

Split Flange Plug - Code 61

SHAPE

Plug

Dash Size	Code 61 Flange
08	1/2"
12	3/4"
16	1"
20	1 1/4"
24	1 1/2"
32	2"
40	2 1/2"
48	3"
56	3 1/2"
64	4"

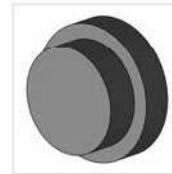

COMPLIANCE
» Code 61

AVAILABILITY
» Steel

Viton 75 Durometer Flange O-Ring

Please note: Viton is a registered trademark of DuPont Dow Elastomers. Visit their site for more information.

SHAPE

O-Ring

Dash Size
08
12
16
20
24
32



COMPLIANCE
» Code 61
» Code 62

AVAILABILITY
» Viton 75
Durometer

90DF



AVAILABILITY

» Buna-Nitrile 90 Durometer

COMPLIANCE

» Code 61
» Code 62

Buna-Nitrile 90 Durometer Flange O-Ring

SHAPE

O-Ring

Dash Size

08
10
12
16
20
24
32
40
48

CP



AVAILABILITY

» Steel

COMPLIANCE

» Code 61

Flange Connector Plate - Code 61

Used to connect (2) O-Ring flanges.

Dash Size

08
12
16
20
24
32
40
48

Code 61 Flange

1/2"
3/4"
1"
1 1/4"
1 1/2"
2"
2 1/2"
3"

SF



AVAILABILITY

» Steel

COMPLIANCE

» Code 61

Split Flange Half - Code 61

To order as a kit that includes: (2) Flange Halves, (4) Grade 8 Hex Head Cap Screws, (4) Spring Lock Washers, and (1) Nitrile O-Ring; add the suffix "K" to the base component part number (Example: SFK-12).

Dash Size

08
12
16
20
24
32
40
48

Code 61 Flange

1/2"
3/4"
1"
1 1/4"
1 1/2"
2"
2 1/2"
3"

Split Flange Kit - Code 61

A kit includes: (2) Flange Halves, (4) Grade 8 Hex Head Cap Screws, (4) Spring Lock Washers, and (1) Nitrile O-Ring.

Dash Size	Code 61 Flange
08	1/2"
12	3/4"
16	1"
20	1 1/4"
24	1 1/2"
32	2"
40	2 1/2"
48	3"



SFK KIT

COMPLIANCE
» Code 61

AVAILABILITY
» Steel

Zero PSI Shipping Plate - Code 61

Not for use on dynamic or pressurized applications.

Dash Size	Code 61 Flange
12	3/4"
16	1"
20	1 1/4"
24	1 1/2"
32	2"
40	2 1/2"



SP

COMPLIANCE
» Code 61

AVAILABILITY
» Steel

Pipe Weld Flange Pad - Code 61

To order as a kit that includes: (4) Square Head Cap Screws, (4) Spring Lock Washers, and (1) Nitrile O-Ring; add the suffix "K" to the base component part number (Example: W4K-12-12).

Dash Size	Pipe Weld	Code 61 Flange
08-08	1/2	1/2"
12-12	3/4	3/4"
16-16	1	1"
20-20	1 1/4	1 1/4"
24-24	1 1/2	1 1/2"
32-32	2	2"
40-40	2 1/2	2 1/2"
48-48	3	3"



W4

COMPLIANCE
» Code 61

AVAILABILITY
» Steel

W43**AVAILABILITY**

» Steel

COMPLIANCE

» Code 61

Pipe Flange Pad - Code 61

To order as a kit that includes: (4) Socket Head Cap Screws, (4) Spring Lock Washers, and (1) Nitrile O-Ring; add the suffix "K" to the base component part number (Example: W43K-12-12).

Dash Size	Female Pipe	Code 61 Flange
08-08	1/2-14	1/2"
12-12	3/4-14	3/4"
16-16	1-11 1/2	1"
16-20	1-11 1/2	1 1/4"
20-20	1 1/4-11 1/2	1 1/4"
24-24	1 1/2-11 1/2	1 1/2"
32-32	2-11 1/2	2"
40-40	2 1/2-8	2 1/2"
48-48	3-8	3"
56-56	3 1/2-8	3 1/2"

W46**AVAILABILITY**

» Steel

COMPLIANCE

» Code 61

O-Ring Flange Pad - Code 61

To order as a kit that includes: (4) Square Head Cap Screws, (4) Spring Lock Washers, and (1) Nitrile O-Ring; add the suffix "K" to the base component part number (Example: W46K-12-12).

Dash Size	Female O-Ring	Code 61 Flange
08-08	3/4-16	1/2"
12-12	1 1/16-12	3/4"
16-16	1 5/16-12	1"
20-20	1 5/8-12	1 1/4"
24-24	1 7/8-12	1 1/2"
32-32	2 1/2-12	2"

Code 62 Flange Components

Braze to Split Flange - Code 62

SHAPE

Straight

Dash Size	Braze Port	Code 62 Flange
08-08	1/2	1/2"
12-12	3/4	3/4"
16-16	1	1"
20-20	1 1/4	1 1/4"
24-24	1 1/2	1 1/2"
32-32	2	2"



COMPLIANCE

» Code 62

AVAILABILITY

» Steel

Split Flange Plug - Code 62

SHAPE

Plug

Dash Size	Code 62 Flange
08	1/2"
12	3/4"
16	1"
20	1 1/4"
24	1 1/2"
32	2"

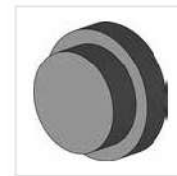

COMPLIANCE

» Code 62

AVAILABILITY

» Steel

Viton 75 Durometer Flange O-Ring

Please note: Viton is a registered trademark of DuPont Dow Elastomers. Visit their site for more information.

SHAPE

O-Ring

Dash Size
08
12
16
20
24
32



COMPLIANCE

» Code 61

» Code 62

AVAILABILITY

» Viton 75 Durometer

90DF**Buna-Nitrile 90 Durometer Flange O-Ring**

SHAPE

O-Ring

Dash Size
08
10
12
16
20
24
32
40
48

AVAILABILITY

» Buna-Nitrile 90 Durometer

COMPLIANCE

» Code 61
» Code 62**CPX****Flange Connector Plate - Code 62**

Used to connect (2) O-Ring flanges.

Dash Size	Code 62 Flange
12	3/4"
16	1"
20	1 1/4"
24	1 1/2"
32	2"

AVAILABILITY

» Steel

COMPLIANCE

» Code 62

SFX**Split Flange Half - Code 62**

To order as a kit that includes: (2) Flange Halves, (4) Grade 8 Hex Head Cap Screws, (4) Spring Lock Washers, and (1) Nitrile O-Ring; add the suffix "K" to the base component part number (Example: SFXK-12).

Dash Size	Code 62 Flange
08	1/2"
12	3/4"
16	1"
20	1 1/4"
24	1 1/2"
32	2"

AVAILABILITY

» Steel

COMPLIANCE

» Code 62

SFXK KIT**Split Flange Kit - Code 62**

A kit includes: (2) Flange Halves, (4) Grade 8 Hex Head Cap Screws, (4) Spring Lock Washers, and (1) Nitrile O-Ring.

Dash Size	Code 62 Flange
08	1/2"
12	3/4"
16	1"
20	1 1/4"
24	1 1/2"
32	2"

AVAILABILITY

» Steel

COMPLIANCE

» Code 62

Zero PSI Shipping Plate - Code 62

Not for use on dynamic or pressurized applications.

Dash Size	Code 62 Flange
12	3/4"
16	1"
20	1 1/4"
24	1 1/2"
32	2"



COMPLIANCE

» Code 62

AVAILABILITY

» Steel

Pipe Weld Flange Pad - Code 62

To order as a kit that includes: (4) Square Head Cap Screws, (4) Spring Lock Washers, and (1) Nitrile O-Ring; add the suffix "K" to the base component part number (Example: W42K-12-12).

Dash Size	Pipe Weld	Code 62 Flange
08-08	1/2	1/2"
12-12	3/4	3/4"
16-16	1	1"
20-20	1 1/4	1 1/4"
24-24	1 1/2	1 1/2"
32-32	2	2"
40-40	2 1/2	2 1/2"
48-48	3	3"



COMPLIANCE

» Code 62

AVAILABILITY

» Steel

Pipe Flange Pad - Code 62

To order as a kit that includes: (4) Square Head Cap Screws, (4) Spring Lock Washers, and (1) Nitrile O-Ring; add the suffix "K" to the base component part number (Example: W44K-12-12).

Dash Size	Female Pipe	Code 62 Flange
08-08	1/2-14	1/2"
12-12	3/4-14	3/4"
16-16	1-11 1/2	1"
20-20	1 1/4-11 1/2	1 1/4"
24-24	1 1/2-11 1/2	1 1/2"
32-32	2-11 1/2	2"



COMPLIANCE

» Code 62

AVAILABILITY

» Steel

W48

O-Ring Flange Pad - Code 62

To order as a kit that includes: (4) Square Head Cap Screws, (4) Spring Lock Washers, and (1) Nitrile O-Ring; add the suffix "K" to the base component part number (Example: W48K-12-12).

Dash Size	Female O-Ring	Code 62 Flange
08-08	3/4-16	1/2"
12-12	1 1/16-12	3/4"
16-16	1 5/16-12	1"
20-20	1 5/8-12	1 1/4"
24-24	1 7/8-12	1 1/2"
32-32	2 1/2-12	2"

AVAILABILITY

» Steel

COMPLIANCE

» Code 62

WC42

Pipe Weld Companion Flange Pad - Code 62

Dash Size	Pipe Weld	Code 62 Flange
08-08	1/2	1/2"
12-12	3/4	3/4"
16-16	1	1"
20-20	1 1/4	1 1/4"
24-24	1 1/2	1 1/2"
32-32	2	2"
48-48	3	3"

AVAILABILITY

» Steel

COMPLIANCE

» Code 62



METRIC ADAPTERS & FITTINGS

BSPB Adapters

3240

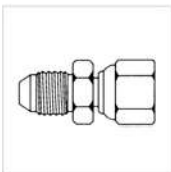

JIC to BSPB Swivel

SHAPE

Straight

Dash Size	Male JIC	Female British Pipe Parallel Swivel
04-02	7/16-20	1/8-28
04-04	7/16-20	1/4-19
04-06	7/16-20	3/8-19
04-08	7/16-20	1/2-14
05-04	1/2-20	1/4-19
05-06	1/2-20	3/8-19
06-04	9/16-18	1/4-19
06-06	9/16-18	3/8-19
06-08	9/16-18	1/2-14
08-06	3/4-16	3/8-19
08-08	3/4-16	1/2-14
08-10	3/4-16	5/8-14
08-12	3/4-16	3/4-14
10-06	7/8-14	3/8-19
10-08	7/8-14	1/2-14
10-10	7/8-14	5/8-14
10-12	7/8-14	3/4-14
12-12	1 1/16-12	3/4-14
12-16	1 1/16-12	1-11
16-12	1 5/16-12	3/4-14
16-16	1 5/16-12	1-11
20-20	1 5/8-12	1 1/4-11
24-24	1 7/8-12	1 1/2-11

AVAILABILITY

» Steel

3401

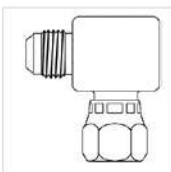

JIC to BSPB Swivel Elbow 90°

SHAPE

90 degree elbow

Dash Size	Male JIC	Female British Pipe Parallel Swivel
04-04	7/16-20	1/4-19
06-06	9/16-18	3/8-19
08-06	3/4-16	3/8-19
08-08	3/4-16	1/2-14
12-12	1 1/16-12	3/4-14

AVAILABILITY

» Steel

3402



JIC to BSPB

For port sealing application be sure to also order a bonded seal washer (DS-BSP).

SHAPE

Straight

Dash Size	Female JIC Swivel	Male British Pipe Parallel
04-02	7/16-20	1/8-28
04-04	7/16-20	1/4-19
04-06	7/16-20	3/8-19
04-08	7/16-20	1/2-14
05-04	1/2-20	1/4-19
06-04	9/16-18	1/4-19

AVAILABILITY

» Steel

Dash Size	Female JIC Swivel	Male British Pipe Parallel
06-06	9/16-18	3/8-19
06-08	9/16-18	1/2-14
08-06	3/4-16	3/8-19
08-08	3/4-16	1/2-14
08-10	3/4-16	5/8-14
08-12	3/4-16	3/4-14
10-06	7/8-14	3/8-19
10-08	7/8-14	1/2-14
10-10	7/8-14	5/8-14
12-08	1 1/16-12	1/2-14
12-10	1 1/16-12	5/8-14
12-12	1 1/16-12	3/4-14
12-16	1 1/16-12	1-11
16-12	1 5/16-12	3/4-14
16-16	1 5/16-12	1-11
16-20	1 5/16-12	1 1/4-11
20-16	1 5/8-12	1-11
20-20	1 5/8-12	1 1/4-11
24-24	1 7/8-12	1 1/2-11
24-32	1 7/8-12	2-11
32-24	2 1/2-12	1 1/2-11
32-32	2 1/2-12	2-11

3402
▼ continued

JIC to BSPP

SHAPE

Straight

Dash Size	Male JIC	Female British Pipe Parallel
04-04	7/16-20	1/4-19
06-04	9/16-18	1/4-19
06-06	9/16-18	3/8-19
08-06	3/4-16	3/8-19
08-08	3/4-16	1/2-14
12-12	1 1/16-12	3/4-14
16-16	1 5/16-12	1-11
20-16	1 5/8-12	1-11
20-20	1 5/8-12	1 1/4-11
24-20	1 7/8-12	1 1/4-11
24-24	1 7/8-12	1 1/2-11

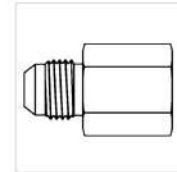

3405

AVAILABILITY
» Steel

BSPP Cap

SHAPE

Cap

Dash Size	Female British Pipe Parallel Swivel
02	1/8-28
04	1/4-19
06	3/8-19
08	1/2-14
10	5/8-14
12	3/4-14
16	1-11
20	1 1/4-11
24	1 1/2-11
32	2-11

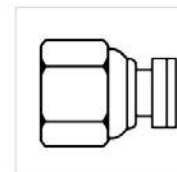

3406

AVAILABILITY
» Steel

3408

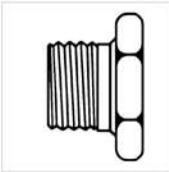

BSPB Plug

For port sealing application be sure to also order a bonded seal washer (DS-BSP).

SHAPE

Plug

Dash Size	Male British Pipe Parallel
02	1/8-28
04	1/4-19
06	3/8-19
08	1/2-14
10	5/8-14
12	3/4-14
16	1-11
20	1 1/4-11
24	1 1/2-11
32	2-11
40	2 1/2-11
48	3-11

AVAILABILITY

» Steel

3408-HHP

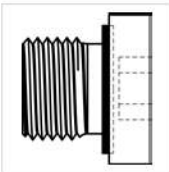

BSPB Hollow Hex Plug

SHAPE

Plug

Dash Size	Male British Pipe Parallel
02	1/8-28
04	1/4-19
06	3/8-19
08	1/2-14
12	3/4-14
16	1-11
20	1 1/4-11
24	1 1/2-11

AVAILABILITY

» Steel

3420



BSPB Union

SHAPE

Straight

Dash Size	Male British Pipe Parallel	Male British Pipe Parallel
02-02	1/8-28	1/8-28
04-02	1/4-19	1/8-28
04-04	1/4-19	1/4-19
06-02	3/8-19	1/8-28
06-04	3/8-19	1/4-19
06-06	3/8-19	3/8-19
08-02	1/2-14	1/8-28
08-04	1/2-14	1/4-19
08-06	1/2-14	3/8-19
08-08	1/2-14	1/2-14
10-04	5/8-14	1/4-19
10-06	5/8-14	3/8-19
10-08	5/8-14	1/2-14
10-10	5/8-14	5/8-14
12-04	3/4-14	1/4-19
12-06	3/4-14	3/8-19
12-08	3/4-14	1/2-14

AVAILABILITY

» Steel

Dash Size	Male British Pipe Parallel	Male British Pipe Parallel
12-10	3/4-14	5/8-14
12-12	3/4-14	3/4-14
16-04	1-11	1/4-19
16-06	1-11	3/8-19
16-08	1-11	1/2-14
16-10	1-11	5/8-14
16-12	1-11	3/4-14
16-16	1-11	1-11
20-06	1 1/4-11	3/8-19
20-08	1 1/4-11	1/2-14
20-10	1 1/4-11	5/8-14
20-12	1 1/4-11	3/4-14
20-16	1 1/4-11	1-11
20-20	1 1/4-11	1 1/4-11
24-08	1 1/2-11	1/2-14
24-12	1 1/2-11	3/4-14
24-16	1 1/2-11	1-11
24-20	1 1/2-11	1 1/4-11
24-24	1 1/2-11	1 1/2-11
32-16	2-11	1-11
32-20	2-11	1 1/4-11
32-24	2-11	1 1/2-11
32-32	2-11	2-11
40-24	2 1/2-11	1 1/2-11
40-32	2 1/2-11	2-11
40-40	2 1/2-11	2 1/2-11
48-32	3-11	2-11
48-40	3-11	2 1/2-11
48-48	3-11	3-11

3420

▼ continued

BSPB Bulkhead Union

SHAPE

Straight

Dash Size	Male British Pipe Parallel	Male British Pipe Parallel
02-02	1/8-28	1/8-28
04-04	1/4-19	1/4-19
04-06	1/4-19	3/8-19
06-04	3/8-19	1/4-19
06-06	3/8-19	3/8-19
06-08	3/8-19	1/2-14
08-06	1/2-14	3/8-19
08-08	1/2-14	1/2-14
08-12	1/2-14	3/4-14
10-10	5/8-14	5/8-14
12-08	3/4-14	1/2-14
12-12	3/4-14	3/4-14
12-16	3/4-14	1-11
16-16	1-11	1-11
20-20	1 1/4-11	1 1/4-11
24-24	1 1/2-11	1 1/2-11
32-32	2-11	2-11

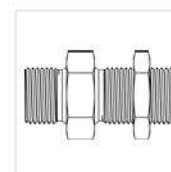
**3421**

AVAILABILITY

» Steel

3422



BSPB Bulkhead Locknut

SHAPE

Nut

Dash Size	Female British Pipe Parallel
02	1/8-28
04	1/4-19
06	3/8-19
08	1/2-14
10	5/8-14
12	3/4-14
16	1-11
20	1 1/4-11
24	1 1/2-11
32	2-11

AVAILABILITY

» Steel

3425

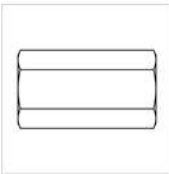

BSPB Coupling

SHAPE

Straight

Dash Size	Female British Pipe Parallel	Female British Pipe Parallel
02-02	1/8-28	1/8-28
04-02	1/4-19	1/8-28
04-04	1/4-19	1/4-19
06-02	3/8-19	1/8-28
06-04	3/8-19	1/4-19
06-06	3/8-19	3/8-19
08-06	1/2-14	3/8-19
08-08	1/2-14	1/2-14
10-08	5/8-14	1/2-14
10-10	5/8-14	5/8-14
12-08	3/4-14	1/2-14
12-12	3/4-14	3/4-14
16-12	1-11	3/4-14
16-16	1-11	1-11
20-20	1 1/4-11	1 1/4-11
24-24	1 1/2-11	1 1/2-11
32-32	2-11	2-11

AVAILABILITY

» Steel

3426

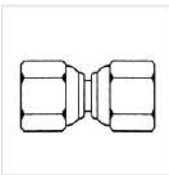

BSPB Swivel Union

SHAPE

Straight

Dash Size	Female British Pipe Parallel Swivel	Female British Pipe Parallel Swivel
02-02	1/8-28	1/8-28
04-04	1/4-19	1/4-19
06-04	3/8-19	1/4-19
06-06	3/8-19	3/8-19
08-04	1/2-14	1/4-19
08-06	1/2-14	3/8-19
08-08	1/2-14	1/2-14
10-08	5/8-14	1/2-14
10-10	5/8-14	5/8-14
12-08	3/4-14	1/2-14
12-10	3/4-14	5/8-14

AVAILABILITY

» Steel

Dash Size	Female British Pipe Parallel Swivel	Female British Pipe Parallel Swivel
12-12	3/4-14	3/4-14
16-08	1-11	1/2-14
16-10	1-11	5/8-14
16-12	1-11	3/4-14
16-16	1-11	1-11
20-12	1 1/4-11	3/4-14
20-20	1 1/4-11	1 1/4-11
24-24	1 1/2-11	1 1/2-11
32-24	2-11	1 1/2-11
32-32	2-11	2-11

3426

▼ continued

BSPP Reducer Bushing

SHAPE

Straight

Dash Size	Male British Pipe Parallel	Female British Pipe Parallel
06-02	3/8-19	1/8-28
08-02	1/2-14	1/8-28
08-04	1/2-14	1/4-19
12-04	3/4-14	1/4-19
12-06	3/4-14	3/8-19
16-04	1-11	1/4-19
16-06	1-11	3/8-19
16-08	1-11	1/2-14
20-08	1 1/4-11	1/2-14
20-12	1 1/4-11	3/4-14
20-16	1 1/4-11	1-11
24-08	1 1/2-11	1/2-14
24-12	1 1/2-11	3/4-14
24-16	1 1/2-11	1-11
32-12	2-11	3/4-14
32-16	2-11	1-11
32-20	2-11	1 1/4-11
32-24	2-11	1 1/2-11
40-32	2 1/2-11	2-11

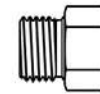
**3430**

AVAILABILITY

» Steel

BSPP to BSPP Extended Bushing

SHAPE

Straight

Dash Size	Male British Pipe Parallel	Female British Pipe Parallel
02-02	1/8-28	1/8-28
02-04	1/8-28	1/4-19
04-02	1/4-19	1/8-28
04-04	1/4-19	1/4-19
04-06	1/4-19	3/8-19
04-08	1/4-19	1/2-14
06-04	3/8-19	1/4-19
06-06	3/8-19	3/8-19
06-08	3/8-19	1/2-14
06-12	3/8-19	3/4-14
08-06	1/2-14	3/8-19
08-08	1/2-14	1/2-14

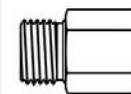
**3435**

AVAILABILITY

» Steel

▼ 3435 continues

3435
▼ continued

Dash Size	Male British Pipe Parallel	Female British Pipe Parallel
08-12	1/2-14	3/4-14
08-16	1/2-14	1-11
10-08	5/8-14	1/2-14
12-08	3/4-14	1/2-14
12-10	3/4-14	5/8-14
12-12	3/4-14	3/4-14
12-16	3/4-14	1-11
12-20	3/4-14	1 1/4-11
16-12	1-11	3/4-14
16-16	1-11	1-11
16-20	1-11	1 1/4-11
16-24	1-11	1 1/2-11
20-20	1 1/4-11	1 1/4-11
24-20	1 1/2-11	1 1/4-11
24-24	1 1/2-11	1 1/2-11
32-32	2-11	2-11

3436

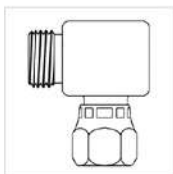

BSPP to BSPP Swivel Elbow 90°

SHAPE

90 degree elbow

AVAILABILITY

» Steel

Dash Size	Male British Pipe Parallel	Female British Pipe Parallel Swivel
02-02	1/8-28	1/8-28
04-04	1/4-19	1/4-19
04-06	1/4-19	3/8-19
06-04	3/8-19	1/4-19
06-06	3/8-19	3/8-19
06-08	3/8-19	1/2-14
08-06	1/2-14	3/8-19
08-08	1/2-14	1/2-14
10-10	5/8-14	5/8-14
12-12	3/4-14	3/4-14
16-12	1-11	3/4-14
16-16	1-11	1-11
20-20	1 1/4-11	1 1/4-11
24-24	1 1/2-11	1 1/2-11
32-32	2-11	2-11

3437

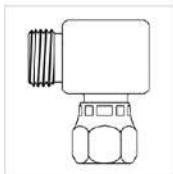

BSPP to JIC Swivel Elbow 90°

SHAPE

90 degree elbow

AVAILABILITY

» Steel

Dash Size	Male British Pipe Parallel	Female JIC Swivel
04-04	1/4-19	7/16-20
04-06	1/4-19	9/16-18
06-06	3/8-19	9/16-18
06-08	3/8-19	3/4-16
08-06	1/2-14	9/16-18
08-08	1/2-14	3/4-16
08-10	1/2-14	7/8-14
10-10	5/8-14	7/8-14
12-12	3/4-14	1 1/16-12

BSPB to Pipe

For port sealing application be sure to also order a bonded seal washer (DS-BSP).

SHAPE

Straight

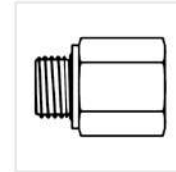

3455

AVAILABILITY

» Steel

Dash Size	Male British Pipe Parallel	Female Pipe
02-02	1/8-28	1/8-27
02-04	1/8-28	1/4-18
04-02	1/4-19	1/8-27
04-04	1/4-19	1/4-18
04-06	1/4-19	3/8-18
06-02	3/8-19	1/8-27
06-04	3/8-19	1/4-18
06-06	3/8-19	3/8-18
06-08	3/8-19	1/2-14
08-02	1/2-14	1/8-27
08-04	1/2-14	1/4-18
08-06	1/2-14	3/8-18
08-08	1/2-14	1/2-14
12-04	3/4-14	1/4-18
12-06	3/4-14	3/8-18
12-08	3/4-14	1/2-14
12-12	3/4-14	3/4-14
16-04	1-11	1/4-18
16-06	1-11	3/8-18
16-08	1-11	1/2-14
16-12	1-11	3/4-14
16-16	1-11	1-11 1/2
20-12	1 1/4-11	3/4-14
20-16	1 1/4-11	1-11 1/2
20-20	1 1/4-11	1 1/4-11 1/2
24-12	1 1/2-11	3/4-14
24-16	1 1/2-11	1-11 1/2
24-20	1 1/2-11	1 1/4-11 1/2
24-24	1 1/2-11	1 1/2-11 1/2
24-32	1 1/2-11	2-11 1/2
32-12	2-11	3/4-14
32-24	2-11	1 1/2-11 1/2
32-32	2-11	2-11 1/2
40-24	2 1/2-11	1 1/2-11 1/2
40-32	2 1/2-11	2-11 1/2
40-40	2 1/2-11	2 1/2-8
48-32	3-11	2-11 1/2
48-48	3-11	3-8

3540

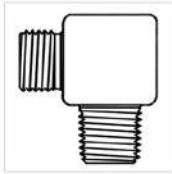

BSPP to BSPT Elbow 90°

SHAPE

90 degree elbow

Dash Size	Male British Pipe Parallel	Male British Pipe Tapered
02-02	1/8-28	1/8-28
02-04	1/8-28	1/4-19
04-02	1/4-19	1/8-28
04-04	1/4-19	1/4-19
04-06	1/4-19	3/8-19
06-04	3/8-19	1/4-19
06-06	3/8-19	3/8-19
08-06	1/2-14	3/8-19
08-08	1/2-14	1/2-14
12-12	3/4-14	3/4-14
16-16	1-11	1-11

AVAILABILITY

» Steel

3544

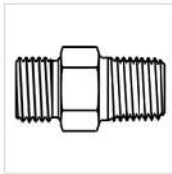

BSPP to BSPT

SHAPE

Straight

Dash Size	Male British Pipe Parallel	Male British Pipe Tapered
02-02	1/8-28	1/8-28
02-04	1/8-28	1/4-19
02-06	1/8-28	3/8-19
04-02	1/4-19	1/8-28
04-04	1/4-19	1/4-19
04-06	1/4-19	3/8-19
04-08	1/4-19	1/2-14
06-02	3/8-19	1/8-28
06-04	3/8-19	1/4-19
06-06	3/8-19	3/8-19
06-08	3/8-19	1/2-14
06-12	3/8-19	3/4-14
06-16	3/8-19	1-11
08-04	1/2-14	1/4-19
08-06	1/2-14	3/8-19
08-08	1/2-14	1/2-14
08-10	1/2-14	5/8-14
08-12	1/2-14	3/4-14
10-06	5/8-14	3/8-19
10-08	5/8-14	1/2-14
10-10	5/8-14	5/8-14
10-12	5/8-14	3/4-14
12-04	3/4-14	1/4-19
12-06	3/4-14	3/8-19
12-08	3/4-14	1/2-14
12-12	3/4-14	3/4-14
12-16	3/4-14	1-11
12-20	3/4-14	1 1/4-11
16-08	1-11	1/2-14
16-12	1-11	3/4-14
16-16	1-11	1-11
16-20	1-11	1 1/4-11
16-24	1-11	1 1/2-11
16-32	1-11	2-11

AVAILABILITY

» Steel

Dash Size	Male British Pipe Parallel	Male British Pipe Tapered
20-12	1 1/4-11	3/4-14
20-16	1 1/4-11	1-11
20-20	1 1/4-11	1 1/4-11
20-24	1 1/4-11	1 1/2-11
20-32	1 1/4-11	2-11
24-16	1 1/2-11	1-11
24-20	1 1/2-11	1 1/4-11
24-24	1 1/2-11	1 1/2-11
24-32	1 1/2-11	2-11
32-24	2-11	1 1/2-11
32-32	2-11	2-11
40-40	2 1/2-11	2 1/2-11
48-48	3-11	3-11

3544

▼ continued

BSPP to BSPP Elbow 90°

SHAPE

90 degree elbow

Dash Size	Male British Pipe Parallel	Male British Pipe Parallel
02-02	1/8-28	1/8-28
04-04	1/4-19	1/4-19
06-04	3/8-19	1/4-19
06-06	3/8-19	3/8-19
08-06	1/2-14	3/8-19
08-08	1/2-14	1/2-14
10-10	5/8-14	5/8-14
12-08	3/4-14	1/2-14
12-10	3/4-14	5/8-14
12-12	3/4-14	3/4-14
16-12	1-11	3/4-14
16-16	1-11	1-11
20-20	1 1/4-11	1 1/4-11
24-24	1 1/2-11	1 1/2-11
32-32	2-11	2-11

**3601**

AVAILABILITY

» Steel

JIC to BSPP Bent Tube Swivel Elbow 45°

SHAPE

45 degree elbow

Dash Size	Male JIC	Female British Pipe Parallel Swivel
04-04	7/16-20	1/4-19
06-06	9/16-18	3/8-19
08-08	3/4-16	1/2-14
10-10	7/8-14	5/8-14
12-12	1 1/16-12	3/4-14
16-16	1 5/16-12	1-11

**3602**

AVAILABILITY

» Steel

3620



SAE O-Ring to BSPB

SHAPE

Straight

AVAILABILITY

» Steel

Dash Size	Male O-Ring	Male British Pipe Parallel
04-04	7/16-20	1/4-19
04-06	7/16-20	3/8-19
04-08	7/16-20	1/2-14
05-04	1/2-20	1/4-19
05-06	1/2-20	3/8-19
06-04	9/16-18	1/4-19
06-06	9/16-18	3/8-19
06-08	9/16-18	1/2-14
08-04	3/4-16	1/4-19
08-06	3/4-16	3/8-19
08-08	3/4-16	1/2-14
08-10	3/4-16	5/8-14
08-12	3/4-16	3/4-14
10-06	7/8-14	3/8-19
10-08	7/8-14	1/2-14
10-10	7/8-14	5/8-14
10-12	7/8-14	3/4-14
12-08	1 1/16-12	1/2-14
12-12	1 1/16-12	3/4-14
12-16	1 1/16-12	1-11
16-12	1 5/16-12	3/4-14
16-16	1 5/16-12	1-11
16-20	1 5/16-12	1 1/4-11
20-16	1 5/8-12	1-11
20-20	1 5/8-12	1 1/4-11
20-24	1 5/8-12	1 1/2-11
24-20	1 7/8-12	1 1/4-11
24-24	1 7/8-12	1 1/2-11

3701

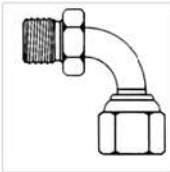

BSPB to BSPB Bent Tube Swivel Elbow 90°

SHAPE

90 degree elbow

AVAILABILITY

» Steel

Dash Size	Male British Pipe Parallel	Female British Pipe Parallel Swivel
04-04	1/4-19	1/4-19
06-06	3/8-19	3/8-19
08-08	1/2-14	1/2-14
10-10	5/8-14	5/8-14
12-12	3/4-14	3/4-14
16-16	1-11	1-11
20-20	1 1/4-11	1 1/4-11
24-24	1 1/2-11	1 1/2-11
32-32	2-11	2-11

BSPB to BSPB Bent Tube Swivel Elbow 45°

SHAPE

45 degree elbow

Dash Size	Male British Pipe Parallel	Female British Pipe Parallel Swivel
04-04	1/4-19	1/4-19
06-06	3/8-19	3/8-19
08-08	1/2-14	1/2-14
10-10	5/8-14	5/8-14
12-12	3/4-14	3/4-14
16-16	1-11	1-11
20-20	1 1/4-11	1 1/4-11

**3702**

AVAILABILITY

» Steel

JIC to BSPB

For port sealing application be sure to also order a bonded seal washer (DS-BSP).

SHAPE

Straight

Dash Size	Male JIC	Male British Pipe Parallel
04-02	7/16-20	1/8-28
04-04	7/16-20	1/4-19
04-06	7/16-20	3/8-19
04-08	7/16-20	1/2-14
05-02	1/2-20	1/8-28
05-04	1/2-20	1/4-19
05-06	1/2-20	3/8-19
06-04	9/16-18	1/4-19
06-06	9/16-18	3/8-19
06-08	9/16-18	1/2-14
08-04	3/4-16	1/4-19
08-06	3/4-16	3/8-19
08-08	3/4-16	1/2-14
08-12	3/4-16	3/4-14
10-06	7/8-14	3/8-19
10-08	7/8-14	1/2-14
10-12	7/8-14	3/4-14
12-08	1 1/16-12	1/2-14
12-10	1 1/16-12	5/8-14
12-12	1 1/16-12	3/4-14
12-16	1 1/16-12	1-11
14-12	1 3/16-12	3/4-14
16-12	1 5/16-12	3/4-14
16-16	1 5/16-12	1-11
16-20	1 5/16-12	1 1/4-11
20-16	1 5/8-12	1-11
20-20	1 5/8-12	1 1/4-11
20-24	1 5/8-12	1 1/2-11
24-20	1 7/8-12	1 1/4-11
24-24	1 7/8-12	1 1/2-11

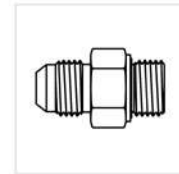
**3800**

AVAILABILITY

» Steel

3800-L

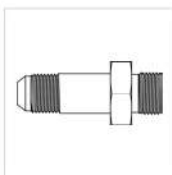

JIC to BSPB LONG

For port sealing application be sure to also order a bonded seal washer (DS-BSP).

SHAPE

Straight

Dash Size	Male JIC	Male British Pipe Parallel
06-04	9/16-18	1/4-19
08-06	3/4-16	3/8-19
08-08	3/4-16	1/2-14
10-08	7/8-14	1/2-14
12-12	1 1/16-12	3/4-14
12-16	1 1/16-12	1-11
16-16	1 5/16-12	1-11
20-20	1 5/8-12	1 1/4-11

AVAILABILITY

» Steel

3801



JIC to BSPB Elbow 90°

SHAPE

90 degree elbow

Dash Size	Male JIC	Male British Pipe Parallel
04-02	7/16-20	1/8-28
04-04	7/16-20	1/4-19
04-06	7/16-20	3/8-19
05-02	1/2-20	1/8-28
05-04	1/2-20	1/4-19
05-06	1/2-20	3/8-19
06-04	9/16-18	1/4-19
06-06	9/16-18	3/8-19
06-08	9/16-18	1/2-14
08-04	3/4-16	1/4-19
08-06	3/4-16	3/8-19
08-08	3/4-16	1/2-14
08-12	3/4-16	3/4-14
10-06	7/8-14	3/8-19
10-08	7/8-14	1/2-14
10-12	7/8-14	3/4-14
12-08	1 1/16-12	1/2-14
12-12	1 1/16-12	3/4-14
12-16	1 1/16-12	1-11
16-12	1 5/16-12	3/4-14
16-16	1 5/16-12	1-11
16-20	1 5/16-12	1 1/4-11
20-16	1 5/8-12	1-11
20-20	1 5/8-12	1 1/4-11
24-24	1 7/8-12	1 1/2-11

AVAILABILITY

» Steel

JIC to BSPP Elbow 45°

SHAPE

45 degree elbow

Dash Size	Male JIC	Male British Pipe Parallel
04-02	7/16-20	1/8-28
04-04	7/16-20	1/4-19
06-04	9/16-18	1/4-19
06-06	9/16-18	3/8-19
08-06	3/4-16	3/8-19
08-08	3/4-16	1/2-14
10-08	7/8-14	1/2-14
12-08	1 1/16-12	1/2-14
12-12	1 1/16-12	3/4-14
16-16	1 5/16-12	1-11
20-20	1 5/8-12	1 1/4-11

**3802**

AVAILABILITY

» Steel

BSPP to BSPT Elbow 45°

SHAPE

45 degree elbow

Dash Size	Male British Pipe Parallel	Male British Pipe Tapered
04-02	1/4-19	1/8-28
04-04	1/4-19	1/4-19
04-06	1/4-19	3/8-19
06-04	3/8-19	1/4-19
06-06	3/8-19	3/8-19
08-06	1/2-14	3/8-19
08-08	1/2-14	1/2-14
12-12	3/4-14	3/4-14
16-16	1-11	1-11

**3807**

AVAILABILITY

» Steel

BSPP to Metric

SHAPE

Straight

Dash Size	Male British Pipe Parallel	Male Metric
02-10X1.5	1/8-28	M10X1.5
02-12	1/8-28	M12X1.5
02-14	1/8-28	M14X1.5
04-10X1.5	1/4-19	M10X1.5
04-12	1/4-19	M12X1.5
04-14	1/4-19	M14X1.5
04-16	1/4-19	M16X1.5
04-18	1/4-19	M18X1.5
04-22	1/4-19	M22X1.5
06-12	3/8-19	M12X1.5
06-14	3/8-19	M14X1.5
06-16	3/8-19	M16X1.5
06-18	3/8-19	M18X1.5
06-20	3/8-19	M20X1.5
06-22	3/8-19	M22X1.5
08-12	1/2-14	M12X1.5
08-14	1/2-14	M14X1.5
08-16	1/2-14	M16X1.5

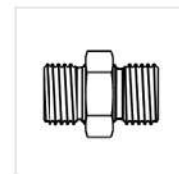
**3810**

AVAILABILITY

» Steel

▼ 3810 continues

3810

▼ continued

Dash Size	Male British Pipe Parallel	Male Metric
08-18	1/2-14	M18X1.5
08-20	1/2-14	M20X1.5
08-22	1/2-14	M22X1.5
08-24	1/2-14	M24X1.5
08-26	1/2-14	M26X1.5
10-20	5/8-14	M20X1.5
10-26	5/8-14	M26X1.5
12-16	3/4-14	M16X1.5
12-18	3/4-14	M18X1.5
12-20	3/4-14	M20X1.5
12-22	3/4-14	M22X1.5
12-24	3/4-14	M24X1.5
12-26	3/4-14	M26X1.5
12-30X1.5	3/4-14	M30X1.5
16-18	1-11	M18X1.5
16-22	1-11	M22X1.5
16-26	1-11	M26X1.5
16-28X1.5	1-11	M28X1.5
16-30X1.5	1-11	M30X1.5
16-36X1.5	1-11	M36X1.5
16-38X1.5	1-11	M38X1.5
20-30X1.5	1 1/4-11	M30X1.5
20-38X1.5	1 1/4-11	M38X1.5
24-38X1.5	1 1/2-11	M38X1.5
24-45X1.5	1 1/2-11	M45X1.5
32-45X1.5	2-11	M45X1.5
32-52X1.5	2-11	M52X1.5

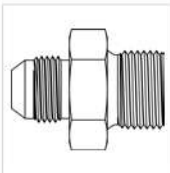
3820**JIC to BSPP Dual Purpose**

For port sealing application be sure to also order a bonded seal washer (DS-BSP).

SHAPE

Straight

Dash Size	Male JIC	Male British Pipe Parallel
04-02	7/16-20	1/8-28
04-04	7/16-20	1/4-19
04-06	7/16-20	3/8-19
04-08	7/16-20	1/2-14
04-12	7/16-20	3/4-14
05-02	1/2-20	1/8-28
05-04	1/2-20	1/4-19
05-06	1/2-20	3/8-19
05-08	1/2-20	1/2-14
06-02	9/16-18	1/8-28
06-04	9/16-18	1/4-19
06-06	9/16-18	3/8-19
06-08	9/16-18	1/2-14
06-10	9/16-18	5/8-14
06-12	9/16-18	3/4-14
08-04	3/4-16	1/4-19
08-06	3/4-16	3/8-19
08-08	3/4-16	1/2-14
08-10	3/4-16	5/8-14
08-12	3/4-16	3/4-14

AVAILABILITY

» Steel

Dash Size	Male JIC	Male British Pipe Parallel
08-16	3/4-16	1-11
10-04	7/8-14	1/4-19
10-06	7/8-14	3/8-19
10-08	7/8-14	1/2-14
10-10	7/8-14	5/8-14
10-12	7/8-14	3/4-14
10-16	7/8-14	1-11
12-04	1 1/16-12	1/4-19
12-06	1 1/16-12	3/8-19
12-08	1 1/16-12	1/2-14
12-10	1 1/16-12	5/8-14
12-12	1 1/16-12	3/4-14
12-16	1 1/16-12	1-11
12-20	1 1/16-12	1 1/4-11
14-12	1 3/16-12	3/4-14
14-16	1 3/16-12	1-11
16-08	1 5/16-12	1/2-14
16-10	1 5/16-12	5/8-14
16-12	1 5/16-12	3/4-14
16-16	1 5/16-12	1-11
16-20	1 5/16-12	1 1/4-11
16-24	1 5/16-12	1 1/2-11
20-12	1 5/8-12	3/4-14
20-16	1 5/8-12	1-11
20-20	1 5/8-12	1 1/4-11
20-24	1 5/8-12	1 1/2-11
24-16	1 7/8-12	1-11
24-20	1 7/8-12	1 1/4-11
24-24	1 7/8-12	1 1/2-11
24-32	1 7/8-12	2-11
32-16	2 1/2-12	1-11
32-20	2 1/2-12	1 1/4-11
32-24	2 1/2-12	1 1/2-11
32-32	2 1/2-12	2-11

3820

▼ continued

BSPP Tee

SHAPE

Tee

Dash Size	Male British Pipe Parallel	Male British Pipe Parallel	Male British Pipe Parallel
02-02-02	1/8-28	1/8-28	1/8-28
04-04-04	1/4-19	1/4-19	1/4-19
06-06-06	3/8-19	3/8-19	3/8-19
08-08-08	1/2-14	1/2-14	1/2-14
10-10-10	5/8-14	5/8-14	5/8-14
12-12-12	3/4-14	3/4-14	3/4-14
16-16-16	1-11	1-11	1-11
20-20-20	1 1/4-11	1 1/4-11	1 1/4-11
24-24-24	1 1/2-11	1 1/2-11	1 1/2-11
32-32-32	2-11	2-11	2-11

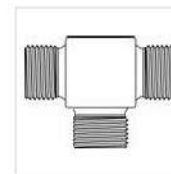
**3823**

AVAILABILITY

» Steel

3825

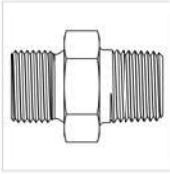

BSPP to Pipe

For port sealing application be sure to also order a bonded seal washer (DS-BSP).

SHAPE

Straight

Dash Size	Male British Pipe Parallel	Male Pipe
02-02	1/8-28	1/8-27
02-04	1/8-28	1/4-18
04-02	1/4-19	1/8-27
04-04	1/4-19	1/4-18
04-06	1/4-19	3/8-18
04-08	1/4-19	1/2-14
06-02	3/8-19	1/8-27
06-04	3/8-19	1/4-18
06-06	3/8-19	3/8-18
06-08	3/8-19	1/2-14
06-12	3/8-19	3/4-14
06-16	3/8-19	1-11 1/2
08-04	1/2-14	1/4-18
08-06	1/2-14	3/8-18
08-08	1/2-14	1/2-14
08-12	1/2-14	3/4-14
08-16	1/2-14	1-11 1/2
10-08	5/8-14	1/2-14
10-12	5/8-14	3/4-14
12-04	3/4-14	1/4-18
12-06	3/4-14	3/8-18
12-08	3/4-14	1/2-14
12-12	3/4-14	3/4-14
12-16	3/4-14	1-11 1/2
12-20	3/4-14	1 1/4-11 1/2
16-08	1-11	1/2-14
16-12	1-11	3/4-14
16-16	1-11	1-11 1/2
16-20	1-11	1 1/4-11 1/2
16-24	1-11	1 1/2-11 1/2
20-16	1 1/4-11	1-11 1/2
20-20	1 1/4-11	1 1/4-11 1/2
20-24	1 1/4-11	1 1/2-11 1/2
24-12	1 1/2-11	3/4-14
24-16	1 1/2-11	1-11 1/2
24-20	1 1/2-11	1 1/4-11 1/2
24-24	1 1/2-11	1 1/2-11 1/2
24-32	1 1/2-11	2-11 1/2
32-20	2-11	1 1/4-11 1/2
32-24	2-11	1 1/2-11 1/2
32-32	2-11	2-11 1/2
32-40	2-11	2 1/2-8
32-48	2-11	3-8
40-32	2 1/2-11	2-11 1/2
40-40	2 1/2-11	2 1/2-8
40-48	2 1/2-11	3-8
48-48	3-11	3-8

AVAILABILITY

» Steel

Pipe to BSPP

SHAPE

Straight

Dash Size	Male Pipe	Female British Pipe Parallel
02-02	1/8-27	1/8-28
04-02	1/4-18	1/8-28
04-04	1/4-18	1/4-19
04-06	1/4-18	3/8-19
06-04	3/8-18	1/4-19
06-06	3/8-18	3/8-19
08-04	1/2-14	1/4-19
08-06	1/2-14	3/8-19
08-08	1/2-14	1/2-14
12-06	3/4-14	3/8-19
12-08	3/4-14	1/2-14
12-12	3/4-14	3/4-14
16-06	1-11 1/2	3/8-19
16-08	1-11 1/2	1/2-14
16-12	1-11 1/2	3/4-14
16-16	1-11 1/2	1-11
20-08	1 1/4-11 1/2	1/2-14
20-20	1 1/4-11 1/2	1 1/4-11
24-20	1 1/2-11 1/2	1 1/4-11
24-24	1 1/2-11 1/2	1 1/2-11
32-16	2-11 1/2	1-11
32-20	2-11 1/2	1 1/4-11
32-32	2-11 1/2	2-11
48-32	3-8	2-11
48-48	3-8	3-11

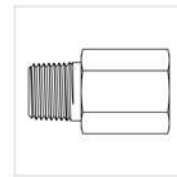

3826

AVAILABILITY

» Steel

BSPP to Pipe Elbow 90°

SHAPE

90 degree elbow

Dash Size	Male British Pipe Parallel	Male Pipe
02-02	1/8-28	1/8-27
04-04	1/4-19	1/4-18
06-06	3/8-19	3/8-18
08-08	1/2-14	1/2-14
12-12	3/4-14	3/4-14
16-16	1-11	1-11 1/2

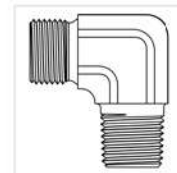

3828

AVAILABILITY

» Steel

3832

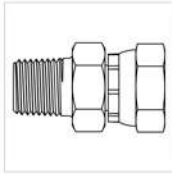

Pipe to BSPB Swivel

SHAPE

Straight

Dash Size	Male Pipe	Female British Pipe Parallel Swivel
02-02	1/8-27	1/8-28
04-04	1/4-18	1/4-19
06-04	3/8-18	1/4-19
06-06	3/8-18	3/8-19
06-08	3/8-18	1/2-14
08-06	1/2-14	3/8-19
08-08	1/2-14	1/2-14
12-08	3/4-14	1/2-14
12-12	3/4-14	3/4-14
16-12	1-11 1/2	3/4-14
16-16	1-11 1/2	1-11

AVAILABILITY

» Steel

3835

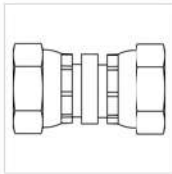

BSPB Swivel to JIC Swivel

SHAPE

Straight

Dash Size	Female British Pipe Parallel Swivel	Female JIC Swivel
04-04	1/4-19	7/16-20
04-05	1/4-19	1/2-20
04-06	1/4-19	9/16-18
06-04	3/8-19	7/16-20
06-05	3/8-19	1/2-20
06-06	3/8-19	9/16-18
06-08	3/8-19	3/4-16
08-06	1/2-14	9/16-18
08-08	1/2-14	3/4-16
10-10	5/8-14	7/8-14
12-08	3/4-14	3/4-16
12-12	3/4-14	1 1/16-12
12-16	3/4-14	1 5/16-12
16-12	1-11	1 1/16-12
16-16	1-11	1 5/16-12
20-20	1 1/4-11	1 5/8-12

AVAILABILITY

» Steel

3840

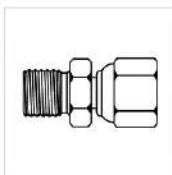

BSPB to BSPB Swivel

SHAPE

Straight

Dash Size	Male British Pipe Parallel	Female British Pipe Parallel Swivel
02-02	1/8-28	1/8-28
02-04	1/8-28	1/4-19
04-02	1/4-19	1/8-28
04-04	1/4-19	1/4-19
04-06	1/4-19	3/8-19
04-08	1/4-19	1/2-14
06-04	3/8-19	1/4-19
06-06	3/8-19	3/8-19
06-08	3/8-19	1/2-14
06-12	3/8-19	3/4-14
08-04	1/2-14	1/4-19

AVAILABILITY

» Steel

Dash Size	Male British Pipe Parallel	Female British Pipe Parallel Swivel
08-06	1/2-14	3/8-19
08-08	1/2-14	1/2-14
08-10	1/2-14	5/8-14
08-12	1/2-14	3/4-14
08-16	1/2-14	1-11
10-08	5/8-14	1/2-14
10-10	5/8-14	5/8-14
10-12	5/8-14	3/4-14
12-06	3/4-14	3/8-19
12-08	3/4-14	1/2-14
12-10	3/4-14	5/8-14
12-12	3/4-14	3/4-14
12-16	3/4-14	1-11
12-20	3/4-14	1 1/4-11
16-08	1-11	1/2-14
16-10	1-11	5/8-14
16-12	1-11	3/4-14
16-16	1-11	1-11
16-20	1-11	1 1/4-11
20-12	1 1/4-11	3/4-14
20-16	1 1/4-11	1-11
20-20	1 1/4-11	1 1/4-11
20-24	1 1/4-11	1 1/2-11
24-16	1 1/2-11	1-11
24-20	1 1/2-11	1 1/4-11
24-24	1 1/2-11	1 1/2-11
32-32	2-11	2-11

3840

▼ continued

BSPB Swivel Union Tee

SHAPE

Tee

Dash Size	Female British Pipe Parallel Swivel	Female British Pipe Parallel Swivel	Female British Pipe Parallel Swivel
02-02-02	1/8-28	1/8-28	1/8-28
04-04-04	1/4-19	1/4-19	1/4-19
06-06-06	3/8-19	3/8-19	3/8-19
08-08-08	1/2-14	1/2-14	1/2-14
10-10-10	5/8-14	5/8-14	5/8-14
12-12-12	3/4-14	3/4-14	3/4-14
16-16-16	1-11	1-11	1-11
20-20-20	1 1/4-11	1 1/4-11	1 1/4-11
24-24-24	1 1/2-11	1 1/2-11	1 1/2-11
32-32-32	2-11	2-11	2-11

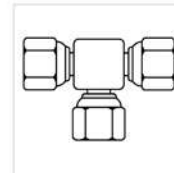
**3853**

AVAILABILITY

» Steel

3854

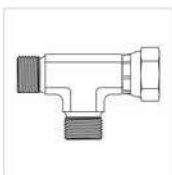

BSPB Swivel Run Tee

SHAPE Tee

Dash Size	Male British Pipe Parallel	Female British Pipe Parallel Swivel	Male British Pipe Parallel
02-02-02	1/8-28	1/8-28	1/8-28
04-04-04	1/4-19	1/4-19	1/4-19
06-06-06	3/8-19	3/8-19	3/8-19
08-08-08	1/2-14	1/2-14	1/2-14
10-10-10	5/8-14	5/8-14	5/8-14
12-12-12	3/4-14	3/4-14	3/4-14
16-16-16	1-11	1-11	1-11
20-20-20	1 1/4-11	1 1/4-11	1 1/4-11

AVAILABILITY

» Steel

3855

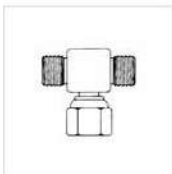

BSPB Swivel Branch Tee

SHAPE Tee

Dash Size	Male British Pipe Parallel	Male British Pipe Parallel	Female British Pipe Parallel Swivel
02-02-02	1/8-28	1/8-28	1/8-28
04-04-04	1/4-19	1/4-19	1/4-19
06-06-06	3/8-19	3/8-19	3/8-19
08-08-08	1/2-14	1/2-14	1/2-14
10-10-10	5/8-14	5/8-14	5/8-14
12-12-12	3/4-14	3/4-14	3/4-14
16-16-16	1-11	1-11	1-11
20-20-20	1 1/4-11	1 1/4-11	1 1/4-11

AVAILABILITY

» Steel

3856

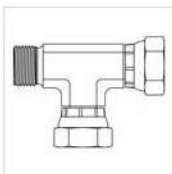

BSPB Run Tee

SHAPE Tee

Dash Size	Male British Pipe Parallel	Female British Pipe Parallel Swivel	Female British Pipe Parallel Swivel
02-02-02	1/8-28	1/8-28	1/8-28
04-04-04	1/4-19	1/4-19	1/4-19
06-06-06	3/8-19	3/8-19	3/8-19
08-08-08	1/2-14	1/2-14	1/2-14
10-10-10	5/8-14	5/8-14	5/8-14
12-12-12	3/4-14	3/4-14	3/4-14
16-16-16	1-11	1-11	1-11
20-20-20	1 1/4-11	1 1/4-11	1 1/4-11

AVAILABILITY

» Steel

BSPP Adjustable Run Tee

SHAPE

Tee

Dash Size	Male British Pipe Parallel	Male British Pipe Parallel	Male British Pipe Parallel
04-04-04	1/4-19	1/4-19	1/4-19
06-04-06	3/8-19	1/4-19	3/8-19
06-06-06	3/8-19	3/8-19	3/8-19
08-06-08	1/2-14	3/8-19	1/2-14
08-08-08	1/2-14	1/2-14	1/2-14
12-12-12	3/4-14	3/4-14	3/4-14

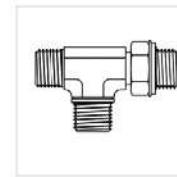

3857

AVAILABILITY

» Steel

BSPP Adjustable Branch Tee

SHAPE

Tee

Dash Size	Male British Pipe Parallel	Male British Pipe Parallel	Male British Pipe Parallel
04-04-04	1/4-19	1/4-19	1/4-19
06-06-04	3/8-19	3/8-19	1/4-19
06-06-06	3/8-19	3/8-19	3/8-19
08-08-06	1/2-14	1/2-14	3/8-19
08-08-08	1/2-14	1/2-14	1/2-14
12-12-12	3/4-14	3/4-14	3/4-14

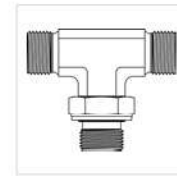

3858

AVAILABILITY

» Steel

JIC to BSPP Adjustable Run Tee

SHAPE

Tee

Dash Size	Male JIC	Male British Pipe Parallel	Male JIC
04-04-04	7/16-20	1/4-19	7/16-20
05-04-05	1/2-20	1/4-19	1/2-20
06-04-06	9/16-18	1/4-19	9/16-18
06-06-06	9/16-18	3/8-19	9/16-18
08-06-08	3/4-16	3/8-19	3/4-16
08-08-08	3/4-16	1/2-14	3/4-16
10-08-10	7/8-14	1/2-14	7/8-14
12-12-12	1 1/16-12	3/4-14	1 1/16-12
16-16-16	1 5/16-12	1-11	1 5/16-12

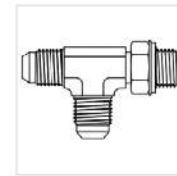

3859

AVAILABILITY

» Steel

JIC to BSPP Adjustable Branch Tee

SHAPE

Tee

Dash Size	Male JIC	Male JIC	Male British Pipe Parallel
04-04-04	7/16-20	7/16-20	1/4-19
05-05-04	1/2-20	1/2-20	1/4-19
06-06-04	9/16-18	9/16-18	1/4-19
06-06-06	9/16-18	9/16-18	3/8-19
08-08-06	3/4-16	3/4-16	3/8-19
08-08-08	3/4-16	3/4-16	1/2-14
10-10-08	7/8-14	7/8-14	1/2-14
12-12-12	1 1/16-12	1 1/16-12	3/4-14
16-16-16	1 5/16-12	1 5/16-12	1-11

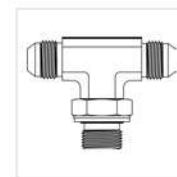

3860

AVAILABILITY

» Steel

3901

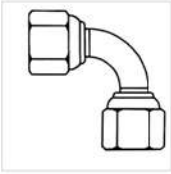

BSPP Swivel Union Elbow 90° Bent Tube

SHAPE

90 degree elbow

Dash Size	Female British Pipe Parallel Swivel	Female British Pipe Parallel Swivel
04-04	1/4-19	1/4-19
06-06	3/8-19	3/8-19
08-08	1/2-14	1/2-14
10-10	5/8-14	5/8-14
12-12	3/4-14	3/4-14
16-16	1-11	1-11
20-20	1 1/4-11	1 1/4-11
24-24	1 1/2-11	1 1/2-11

AVAILABILITY

» Steel

3903



BSPP Swivel Union Elbow 45° Bent Tube

SHAPE

45 degree elbow

Dash Size	Female British Pipe Parallel Swivel	Female British Pipe Parallel Swivel
04-04	1/4-19	1/4-19
06-06	3/8-19	3/8-19
08-08	1/2-14	1/2-14
10-10	5/8-14	5/8-14
12-12	3/4-14	3/4-14
16-16	1-11	1-11
20-20	1 1/4-11	1 1/4-11

AVAILABILITY

» Steel

3904

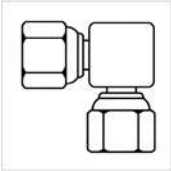

BSPP Swivel Union Elbow 90°

SHAPE

90 degree elbow

Dash Size	Female British Pipe Parallel Swivel	Female British Pipe Parallel Swivel
02-02	1/8-28	1/8-28
04-04	1/4-19	1/4-19
06-06	3/8-19	3/8-19
08-08	1/2-14	1/2-14
10-10	5/8-14	5/8-14
12-12	3/4-14	3/4-14
16-16	1-11	1-11
20-20	1 1/4-11	1 1/4-11
24-24	1 1/2-11	1 1/2-11
32-32	2-11	2-11

AVAILABILITY

» Steel

3905

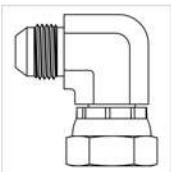

JIC to BSPP Swivel Elbow 90°

SHAPE

90 degree elbow

Dash Size	Male JIC	Female British Pipe Parallel Swivel
04-04	7/16-20	1/4-19
06-06	9/16-18	3/8-19
08-08	3/4-16	1/2-14
10-10	7/8-14	5/8-14
12-12	1 1/16-12	3/4-14
16-16	1 5/16-12	1-11

AVAILABILITY

» Steel

Bonded Seal for British Pipe

SHAPE

O-Ring

Dash Size

02
04
06
08
10
12
16
20
24
32
40
48



DS-BSP

AVAILABILITY

» Steel

ORFS to BSPP

SHAPE

Straight

Dash Size

Male O-Ring Face Seal

Male British Pipe Parallel

04-02	9/16-18	1/8-28
04-04	9/16-18	1/4-19
04-06	9/16-18	3/8-19
06-04	11/16-16	1/4-19
06-06	11/16-16	3/8-19
06-08	11/16-16	1/2-14
08-04	13/16-16	1/4-19
08-06	13/16-16	3/8-19
08-08	13/16-16	1/2-14
08-12	13/16-16	3/4-14
10-08	1-14	1/2-14
12-08	1 3/16-12	1/2-14
12-12	1 3/16-12	3/4-14
12-16	1 3/16-12	1-11
16-12	1 7/16-12	3/4-14
16-16	1 7/16-12	1-11
16-20	1 7/16-12	1 1/4-11
20-16	1 11/16-12	1-11
20-20	1 11/16-12	1 1/4-11
24-24	2-12	1 1/2-11

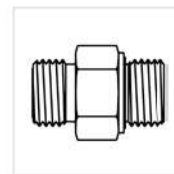

FF3800

AVAILABILITY

» Steel

FF3801

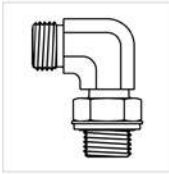

ORFS to BSPB Elbow 90°

SHAPE

90 degree elbow

Dash Size	Male O-Ring Face Seal	Male British Pipe Parallel
04-02	9/16-18	1/8-28
04-04	9/16-18	1/4-19
04-06	9/16-18	3/8-19
06-04	11/16-16	1/4-19
06-06	11/16-16	3/8-19
06-08	11/16-16	1/2-14
08-04	13/16-16	1/4-19
08-06	13/16-16	3/8-19
08-08	13/16-16	1/2-14
10-08	1-14	1/2-14
12-08	1 3/16-12	1/2-14
12-12	1 3/16-12	3/4-14
12-16	1 3/16-12	1-11
16-12	1 7/16-12	3/4-14
16-16	1 7/16-12	1-11
16-20	1 7/16-12	1 1/4-11
20-16	1 11/16-12	1-11
20-20	1 11/16-12	1 1/4-11
24-24	2-12	1 1/2-11

AVAILABILITY

» Steel

FF3802



ORFS to BSPB Elbow 45°

SHAPE

45 degree elbow

Dash Size	Male O-Ring Face Seal	Male British Pipe Parallel
04-02	9/16-18	1/8-28
04-04	9/16-18	1/4-19
06-04	11/16-16	1/4-19
06-06	11/16-16	3/8-19
08-06	13/16-16	3/8-19
08-08	13/16-16	1/2-14
10-08	1-14	1/2-14

AVAILABILITY

» Steel

FF3859

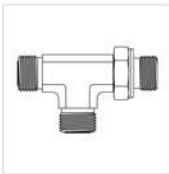

ORFS to BSPB Run Tee

SHAPE

Tee

Dash Size	Male O-Ring Face Seal	Male British Pipe Parallel	Male O-Ring Face Seal
06-04-06	11/16-16	1/4-19	11/16-16
06-06-06	11/16-16	3/8-19	11/16-16
08-06-08	13/16-16	3/8-19	13/16-16
08-08-08	13/16-16	1/2-14	13/16-16
10-08-10	1-14	1/2-14	1-14
12-12-12	1 3/16-12	3/4-14	1 3/16-12
12-16-12	1 3/16-12	1-11	1 3/16-12
16-16-16	1 7/16-12	1-11	1 7/16-12

AVAILABILITY

» Steel

ORFS to BSPB Branch Tee

SHAPE

Tee

Dash Size	Male O-Ring Face Seal	Male O-Ring Face Seal	Male British Pipe Parallel
04-04-02	9/16-18	9/16-18	1/8-28
04-04-04	9/16-18	9/16-18	1/4-19
06-06-04	11/16-16	11/16-16	1/4-19
06-06-06	11/16-16	11/16-16	3/8-19
08-08-06	13/16-16	13/16-16	3/8-19
08-08-08	13/16-16	13/16-16	1/2-14
10-10-08	1-14	1-14	1/2-14

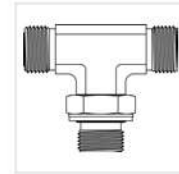
FF3860
AVAILABILITY

» Steel

BSPT Adapters

3404

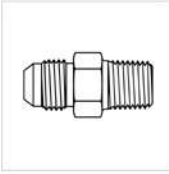

JIC to BSPT

SHAPE

Straight

Dash Size	Male JIC	Male British Pipe Tapered
04-02	7/16-20	1/8-28
04-04	7/16-20	1/4-19
04-06	7/16-20	3/8-19
05-02	1/2-20	1/8-28
05-04	1/2-20	1/4-19
05-06	1/2-20	3/8-19
06-02	9/16-18	1/8-28
06-04	9/16-18	1/4-19
06-06	9/16-18	3/8-19
06-08	9/16-18	1/2-14
08-04	3/4-16	1/4-19
08-06	3/4-16	3/8-19
08-08	3/4-16	1/2-14
08-12	3/4-16	3/4-14
08-16	3/4-16	1-11
10-06	7/8-14	3/8-19
10-08	7/8-14	1/2-14
10-12	7/8-14	3/4-14
12-08	1 1/16-12	1/2-14
12-12	1 1/16-12	3/4-14
12-16	1 1/16-12	1-11
14-12	1 3/16-12	3/4-14
16-12	1 5/16-12	3/4-14
16-16	1 5/16-12	1-11
16-20	1 5/16-12	1 1/4-11
20-16	1 5/8-12	1-11
20-20	1 5/8-12	1 1/4-11
20-24	1 5/8-12	1 1/2-11
24-24	1 7/8-12	1 1/2-11
24-32	1 7/8-12	2-11
32-32	2 1/2-12	2-11

3501

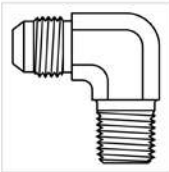

JIC to BSPT Elbow 90°

SHAPE

90 degree elbow

Dash Size	Male JIC	Male British Pipe Tapered
04-02	7/16-20	1/8-28
04-04	7/16-20	1/4-19
05-02	1/2-20	1/8-28
05-04	1/2-20	1/4-19
06-04	9/16-18	1/4-19
06-06	9/16-18	3/8-19
06-08	9/16-18	1/2-14
08-04	3/4-16	1/4-19
08-06	3/4-16	3/8-19

AVAILABILITY

» Steel

AVAILABILITY

» Steel

Dash Size	Male JIC	Male British Pipe Tapered
08-08	3/4-16	1/2-14
10-08	7/8-14	1/2-14
10-12	7/8-14	3/4-14
12-08	1 1/16-12	1/2-14
12-12	1 1/16-12	3/4-14
12-16	1 1/16-12	1-11
16-12	1 5/16-12	3/4-14
16-16	1 5/16-12	1-11
20-16	1 5/8-12	1-11
20-20	1 5/8-12	1 1/4-11
24-24	1 7/8-12	1 1/2-11
32-32	2 1/2-12	2-11

3501

▼ continued

JIC to BSPT Elbow 45°

SHAPE

45 degree elbow

Dash Size	Male JIC	Male British Pipe Tapered
04-02	7/16-20	1/8-28
04-04	7/16-20	1/4-19
06-04	9/16-18	1/4-19
06-06	9/16-18	3/8-19
08-06	3/4-16	3/8-19
08-08	3/4-16	1/2-14
10-08	7/8-14	1/2-14
12-12	1 1/16-12	3/4-14
16-12	1 5/16-12	3/4-14
16-16	1 5/16-12	1-11
20-20	1 5/8-12	1 1/4-11

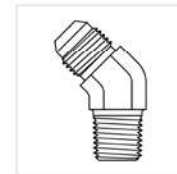
**3503**

AVAILABILITY

» Steel

BSPT Reducer Bushing

SHAPE

Straight

Dash Size	Male British Pipe Tapered	Female British Pipe Tapered
04-02	1/4-19	1/8-28
06-02	3/8-19	1/8-28
06-04	3/8-19	1/4-19
08-04	1/2-14	1/4-19
08-06	1/2-14	3/8-19
12-06	3/4-14	3/8-19
12-08	3/4-14	1/2-14
16-08	1-11	1/2-14
16-12	1-11	3/4-14

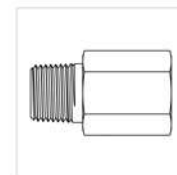
**3506**

AVAILABILITY

» Steel

3508

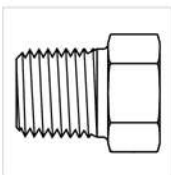

BSPT Plug

SHAPE

Plug

Dash Size	Male British Pipe Tapered
02	1/8-28
04	1/4-19
06	3/8-19
08	1/2-14
10	5/8-14
12	3/4-14
16	1-11
20	1 1/4-11
24	1 1/2-11
32	2-11

AVAILABILITY

» Steel

3508-HHP



BSPT Countersunk Plug

SHAPE

Plug

Dash Size	Male British Pipe Tapered
02	1/8-28
04	1/4-19
06	3/8-19
08	1/2-14
12	3/4-14
16	1-11

AVAILABILITY

» Steel

3520

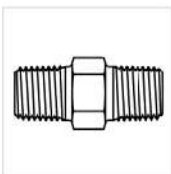

BSPT Hex Nipple

SHAPE

Straight

Dash Size	Male British Pipe Tapered	Male British Pipe Tapered
02-02	1/8-28	1/8-28
04-02	1/4-19	1/8-28
04-04	1/4-19	1/4-19
06-02	3/8-19	1/8-28
06-04	3/8-19	1/4-19
06-06	3/8-19	3/8-19
08-04	1/2-14	1/4-19
08-06	1/2-14	3/8-19
08-08	1/2-14	1/2-14
10-10	5/8-14	5/8-14
12-08	3/4-14	1/2-14
12-12	3/4-14	3/4-14
16-12	1-11	3/4-14
16-16	1-11	1-11
20-16	1 1/4-11	1-11
20-20	1 1/4-11	1 1/4-11
24-24	1 1/2-11	1 1/2-11
32-32	2-11	2-11
40-40	2 1/2-11	2 1/2-11
48-48	3-11	3-11

AVAILABILITY

» Steel

BSPT to Pipe

SHAPE

Straight

Dash Size	Male British Pipe Tapered	Male Pipe
02-02	1/8-28	1/8-27
04-02	1/4-19	1/8-27
04-04	1/4-19	1/4-18
04-06	1/4-19	3/8-18
06-04	3/8-19	1/4-18
06-06	3/8-19	3/8-18
08-08	1/2-14	1/2-14
12-12	3/4-14	3/4-14
16-16	1-11	1-11 1/2
20-20	1 1/4-11	1 1/4-11 1/2
24-24	1 1/2-11	1 1/2-11 1/2
32-32	2-11	2-11 1/2
40-40	2 1/2-11	2 1/2-8
48-48	3-11	3-8

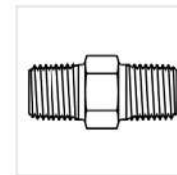

3524

AVAILABILITY

» Steel

BSPT to BSPP

SHAPE

Straight

Dash Size	Male British Pipe Tapered	Female British Pipe Parallel
04-02	1/4-19	1/8-28
04-04	1/4-19	1/4-19
06-02	3/8-19	1/8-28
06-04	3/8-19	1/4-19
06-06	3/8-19	3/8-19
08-08	1/2-14	1/2-14
12-04	3/4-14	1/4-19
12-06	3/4-14	3/8-19
12-08	3/4-14	1/2-14
12-12	3/4-14	3/4-14
16-08	1-11	1/2-14
16-12	1-11	3/4-14
16-16	1-11	1-11
20-16	1 1/4-11	1-11
20-20	1 1/4-11	1 1/4-11
24-20	1 1/2-11	1 1/4-11

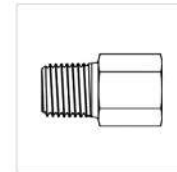

3545

AVAILABILITY

» Steel

JIC to BSPT Run Tee

SHAPE

Tee

Dash Size	Male JIC	Male British Pipe Tapered	Male JIC
04-04-04	7/16-20	1/4-19	7/16-20
06-04-06	9/16-18	1/4-19	9/16-18
08-06-08	3/4-16	3/8-19	3/4-16
10-08-10	7/8-14	1/2-14	7/8-14
12-12-12	1 1/16-12	3/4-14	1 1/16-12

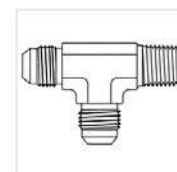

3656

AVAILABILITY

» Steel

3657**JIC to BSPT Branch Tee**

SHAPE

Tee

Dash Size	Male JIC	Male JIC	Male British Pipe Tapered
06-06-04	9/16-18	9/16-18	1/4-19
08-08-06	3/4-16	3/4-16	3/8-19
10-10-08	7/8-14	7/8-14	1/2-14
12-12-12	1 1/16-12	1 1/16-12	3/4-14

AVAILABILITY

» Steel

3827**BSPT to BSPP Swivel Elbow 90°**

SHAPE

90 degree elbow

Dash Size	Male British Pipe Tapered	Female British Pipe Parallel Swivel
02-02	1/8-28	1/8-28
04-04	1/4-19	1/4-19
06-06	3/8-19	3/8-19
08-08	1/2-14	1/2-14
12-12	3/4-14	3/4-14
16-16	1-11	1-11

AVAILABILITY

» Steel

Metric Adapters

JIC to Metric

For port sealing application, be sure to also order a bonded seal washer (DS-BSP).

SHAPE

Straight

Dash Size	Male JIC	Male Metric
04-10	7/16-20	M10X1.0
04-12	7/16-20	M12X1.5
04-14	7/16-20	M14X1.5
04-18	7/16-20	M18X1.5
05-12	1/2-20	M12X1.5
05-14	1/2-20	M14X1.5
05-16	1/2-20	M16X1.5
06-12	9/16-18	M12X1.5
06-12X1.25	9/16-18	M12X1.25
06-14	9/16-18	M14X1.5
06-16	9/16-18	M16X1.5
06-18	9/16-18	M18X1.5
08-14	3/4-16	M14X1.5
08-16	3/4-16	M16X1.5
08-18	3/4-16	M18X1.5
08-22	3/4-16	M22X1.5
10-16	7/8-14	M16X1.5
10-18	7/8-14	M18X1.5
10-20	7/8-14	M20X1.5
10-22	7/8-14	M22X1.5
12-18	1 1/16-12	M18X1.5
12-22	1 1/16-12	M22X1.5
12-26	1 1/16-12	M26X1.5
12-27	1 1/16-12	M27X2.0
12-27X1.5	1 1/16-12	M27X1.5
14-26	1 3/16-12	M26X1.5
16-27	1 5/16-12	M27X2.0
16-33	1 5/16-12	M33X2.0
20-33	1 5/8-12	M33X2.0
20-42	1 5/8-12	M42X2.0
24-48	1 7/8-12	M48X2.0

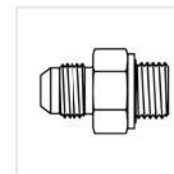

7400

AVAILABILITY

» Steel

JIC to Metric

SHAPE

Straight

Dash Size	Female JIC Swivel	Male Metric
04-10	7/16-20	M10X1.0
04-12	7/16-20	M12X1.5
05-12	1/2-20	M12X1.5
06-14	9/16-18	M14X1.5
06-16	9/16-18	M16X1.5
06-18	9/16-18	M18X1.5
06-20	9/16-18	M20X1.5
06-22	9/16-18	M22X1.5

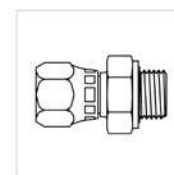

7402

AVAILABILITY

» Steel

▼ 7402 continues

7402
▼ continued

Dash Size	Female JIC Swivel	Male Metric
08-16	3/4-16	M16X1.5
08-18	3/4-16	M18X1.5
08-20	3/4-16	M20X1.5
08-22	3/4-16	M22X1.5
10-16	7/8-14	M16X1.5
10-18	7/8-14	M18X1.5
10-20	7/8-14	M20X1.5
10-22	7/8-14	M22X1.5
12-27	1 1/16-12	M27X2.0
16-33	1 5/16-12	M33X2.0

7408

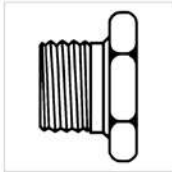

Metric Hex Head Plug

SHAPE

Plug

Dash Size	Male Metric
08	M8X1.0
10	M10X1.0
10X1.5	M10X1.5
12	M12X1.5
12X1.0	M12X1.0
14	M14X1.5
16	M16X1.5
18	M18X1.5
20	M20X1.5
22	M22X1.5
24	M24X1.5
26	M26X1.5
30	M30X2.0

AVAILABILITY

» Steel

7408-HHP

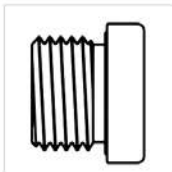

Metric Hollow Hex Plug

SHAPE

Plug

Dash Size	Male Metric
08	M8X1.0
10	M10X1.0
12	M12X1.5
14	M14X1.5
16	M16X1.5
18	M18X1.5
20	M20X1.5
22	M22X1.5
24	M24X1.5
26	M26X1.5
27	M27X2.0
30	M30X2.0
33	M33X2.0
42	M42X2.0

AVAILABILITY

» Steel

JIC to Metric Dual Purpose

For port sealing application be sure to also order a bonded seal washer (DS-MM).

SHAPE

Straight

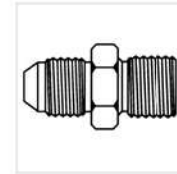

7420

AVAILABILITY

» Steel

Dash Size	Male JIC	Male Metric Compression
04-LLO6-10	7/16-20	LLO6 (10x1.0)
04-LLO8-12	7/16-20	LLO8 (12x1.0)
06-LLO8-12	9/16-18	LLO8 (12x1.0)
04-L06-12	7/16-20	L06 (12x1.5)
04-L08-14	7/16-20	L08 (14x1.5)
04-L12-18	7/16-20	L12 (18x1.5)
06-L08-14	9/16-18	L08 (14x1.5)
06-L10-16	9/16-18	L10 (16x1.5)
06-L12-18	9/16-18	L12 (18x1.5)
08-L10-16	3/4-16	L10 (16x1.5)
08-L12-18	3/4-16	L12 (18x1.5)
08-L15-22	3/4-16	L15 (22x1.5)
10-L12-18	7/8-14	L12 (18x1.5)
10-L15-22	7/8-14	L15 (22x1.5)
10-L18-26	7/8-14	L18 (26x1.5)
12-L15-22	1 1/16-12	L15 (22x1.5)
12-L18-26	1 1/16-12	L18 (26x1.5)
12-L22-30X1.5	1 1/16-12	L22 (30x1.5)
12-L22-30X2.0	1 1/16-12	L22 (30x2.0)
16-L22-30X1.5	1 5/16-12	L22 (30x1.5)
16-L28-36	1 5/16-12	L28 (36x2.0)
20-L35-45	1 5/8-12	L35 (45x2.0)
24-L42-52	1 7/8-12	L42 (52x2.0)
04-S06-14	7/16-20	S06 (14x1.5)
04-S08-16	7/16-20	S08 (16x1.5)
04-S10-18	7/16-20	S10 (18x1.5)
06-S08-16	9/16-18	S08 (16x1.5)
06-S10-18	9/16-18	S10 (18x1.5)
06-S12-20	9/16-18	S12 (20x1.5)
06-S14-22	9/16-18	S14 (22x1.5)
08-S10-18	3/4-16	S10 (18x1.5)
08-S12-20	3/4-16	S12 (20x1.5)
08-S14-22	3/4-16	S14 (22x1.5)
08-S16-24	3/4-16	S16 (24x1.5)
10-S12-20	7/8-14	S12 (20x1.5)
10-S16-24	7/8-14	S16 (24x1.5)
12-S16-24	1 1/16-12	S16 (24x1.5)
12-S20-30	1 1/16-12	S20 (30x2.0)
12-S25-36	1 1/16-12	S25 (36x2.0)
16-S20-30	1 5/16-12	S20 (30x2.0)
16-S25-36	1 5/16-12	S25 (36x2.0)
16-S30-42	1 5/16-12	S30 (42x2.0)
20-S30-42	1 5/8-12	S30 (42x2.0)
20-S38-52	1 5/8-12	S38 (52x2.0)
24-S38-52	1 7/8-12	S38 (52x2.0)

7430

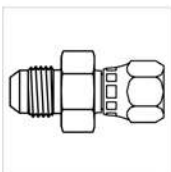

JIC to Metric Swivel

SHAPE

Straight

Dash Size	Male JIC	Female Metric Compression
04-L06-12	7/16-20	L06 (12x1.5)
04-L08-14	7/16-20	L08 (14x1.5)
05-L06-12	1/2-20	L06 (12x1.5)
06-L08-14	9/16-18	L08 (14x1.5)
06-L10-16	9/16-18	L10 (16x1.5)
06-L12-18	9/16-18	L12 (18x1.5)
06-L15-22	9/16-18	L15 (22x1.5)
08-L10-16	3/4-16	L10 (16x1.5)
08-L12-18	3/4-16	L12 (18x1.5)
08-L15-22	3/4-16	L15 (22x1.5)
10-L12-18	7/8-14	L12 (18x1.5)
10-L15-22	7/8-14	L15 (22x1.5)
06-S12-20	9/16-18	S12 (20x1.5)
08-S12-20	3/4-16	S12 (20x1.5)
10-S12-20	7/8-14	S12 (20x1.5)

AVAILABILITY

» Steel

7455

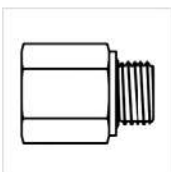

Pipe to Metric

SHAPE

Straight

Dash Size	Female Pipe	Male Metric
02-06	1/8-27	M6X1.0
02-08	1/8-27	M8X1.0
02-10	1/8-27	M10X1.0
02-10X1.5	1/8-27	M10X1.5
02-12	1/8-27	M12X1.5
02-14	1/8-27	M14X1.5
04-10	1/4-18	M10X1.0
04-12	1/4-18	M12X1.5
04-14	1/4-18	M14X1.5
04-16	1/4-18	M16X1.5
04-18	1/4-18	M18X1.5
04-20	1/4-18	M20X1.5
06-12	3/8-18	M12X1.5
06-14	3/8-18	M14X1.5
06-16	3/8-18	M16X1.5
06-18	3/8-18	M18X1.5
06-20	3/8-18	M20X1.5
06-22	3/8-18	M22X1.5
08-16	1/2-14	M16X1.5
08-18	1/2-14	M18X1.5
08-20	1/2-14	M20X1.5
08-22	1/2-14	M22X1.5
12-22	3/4-14	M22X1.5
12-24	3/4-14	M24X1.5
12-26	3/4-14	M26X1.5
12-27	3/4-14	M27X2.0
16-33	1-11 1/2	M33X2.0

AVAILABILITY

» Steel

JIC to Metric Standpipe

SHAPE

Straight

Dash Size	Male JIC	Metric Standpipe
04-04	7/16-20	4mm
04-06	7/16-20	6mm
04-08	7/16-20	8mm
04-10	7/16-20	10mm
05-12	1/2-20	12mm
06-08	9/16-18	8mm
06-10	9/16-18	10mm
06-12	9/16-18	12mm
06-14	9/16-18	14mm
08-10	3/4-16	10mm
08-12	3/4-16	12mm
08-14	3/4-16	14mm
08-15	3/4-16	15mm
08-16	3/4-16	16mm
10-16	7/8-14	16mm
10-18	7/8-14	18mm
10-20	7/8-14	20mm
12-16	1 1/16-12	16mm
12-18	1 1/16-12	18mm
12-20	1 1/16-12	20mm
12-22	1 1/16-12	22mm
12-25	1 1/16-12	25mm
16-20	1 5/16-12	20mm
16-25	1 5/16-12	25mm
16-28	1 5/16-12	28mm
16-30	1 5/16-12	30mm
20-35	1 5/8-12	35mm
20-38	1 5/8-12	38mm
24-35	1 7/8-12	35mm
24-38	1 7/8-12	38mm
24-42	1 7/8-12	42mm

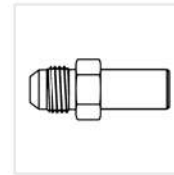

7625

AVAILABILITY

» Steel

JIC to Metric Elbow 90°

SHAPE

90 degree elbow

Dash Size	Male JIC	Male Metric
04-10	7/16-20	M10X1.0
04-12	7/16-20	M12X1.5
04-14	7/16-20	M14X1.5
05-10	1/2-20	M10X1.0
05-12	1/2-20	M12X1.5
05-14	1/2-20	M14X1.5
06-12	9/16-18	M12X1.5
06-14	9/16-18	M14X1.5
06-16	9/16-18	M16X1.5
06-18	9/16-18	M18X1.5
08-16	3/4-16	M16X1.5
08-18	3/4-16	M18X1.5
08-22	3/4-16	M22X1.5
10-18	7/8-14	M18X1.5

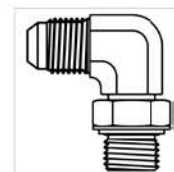

7801

AVAILABILITY

» Steel

▼ 7801 continues

7801
▼ continued

Dash Size	Male JIC	Male Metric
10-20	7/8-14	M20X1.5
10-22	7/8-14	M22X1.5
12-22	1 1/16-12	M22X1.5
12-26	1 1/16-12	M26X1.5
12-27	1 1/16-12	M27X2.0
14-26	1 3/16-12	M26X1.5
16-27	1 5/16-12	M27X2.0
16-33	1 5/16-12	M33X2.0
20-42	1 5/8-12	M42X2.0
24-48	1 7/8-12	M48X2.0

7802



JIC to Metric Elbow 45°

SHAPE

45 degree elbow

Dash Size	Male JIC	Male Metric
04-10	7/16-20	M10X1.0
06-14	9/16-18	M14X1.5
06-16	9/16-18	M16X1.5
08-16	3/4-16	M16X1.5
08-18	3/4-16	M18X1.5
10-18	7/8-14	M18X1.5
10-22	7/8-14	M22X1.5
12-22	1 1/16-12	M22X1.5
12-27	1 1/16-12	M27X2.0
16-27	1 5/16-12	M27X2.0
16-33	1 5/16-12	M33X2.0

AVAILABILITY

» Steel

DS-MM



Bonded Seal for Metric Parallel Thread

SHAPE

O-Ring

Dash Size
06
08
10
12
14
16
18
20
22
24
26
27
30
33
36
42
45
50
52

AVAILABILITY

» Steel

ORFS to Metric

SHAPE

Straight

Dash Size	Male O-Ring Face Seal	Male Metric
04-10	9/16-18	M10X1.0
04-12	9/16-18	M12X1.5
06-12	11/16-16	M12X1.5
06-14	11/16-16	M14X1.5
06-16	11/16-16	M16X1.5
08-16	13/16-16	M16X1.5
08-18	13/16-16	M18X1.5
08-22	13/16-16	M22X1.5
10-18	1-14	M18X1.5
10-22	1-14	M22X1.5
12-22	1 3/16-12	M22X1.5
12-26	1 3/16-12	M26X1.5
12-27	1 3/16-12	M27X2.0
16-27	1 7/16-12	M27X2.0
16-33	1 7/16-12	M33X2.0

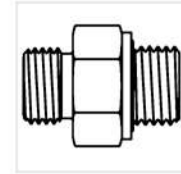

FF7400

AVAILABILITY

» Steel

ORFS to Metric Elbow 90°

SHAPE

90 degree elbow

Dash Size	Male O-Ring Face Seal	Male Metric
04-10	9/16-18	M10X1.0
04-12	9/16-18	M12X1.5
06-14	11/16-16	M14X1.5
06-16	11/16-16	M16X1.5
08-16	13/16-16	M16X1.5
08-18	13/16-16	M18X1.5
10-18	1-14	M18X1.5
10-22	1-14	M22X1.5
12-27	1 3/16-12	M27X2.0
16-33	1 7/16-12	M33X2.0
20-33	1 11/16-12	M33X2.0

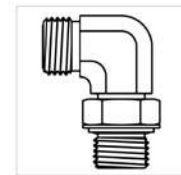

FF7801

AVAILABILITY

» Steel

30° Seat Adapters

3223



JIS to BSPT

SHAPE

Straight

Dash Size	Male JIS	Male British Pipe Tapered
04-02	1/4-19	1/8-28
04-04	1/4-19	1/4-19
04-06	1/4-19	3/8-19
06-04	3/8-19	1/4-19
06-06	3/8-19	3/8-19
08-06	1/2-14	3/8-19
08-08	1/2-14	1/2-14
12-12	3/4-14	3/4-14
16-16	1-11	1-11

AVAILABILITY

» Steel

3224

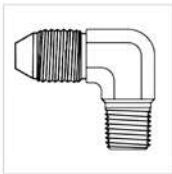

JIS to BSPT 90°

SHAPE

90 degree elbow

Dash Size	Male JIS	Male British Pipe Tapered
04-04	1/4-19	1/4-19
06-06	3/8-19	3/8-19
08-08	1/2-14	1/2-14
12-12	3/4-14	3/4-14
16-16	1-11	1-11

AVAILABILITY

» Steel

3225



JIS to BSPT 45°

SHAPE

45 degree elbow

Dash Size	Male JIS	Male British Pipe Tapered
04-04	1/4-19	1/4-19
06-06	3/8-19	3/8-19
08-08	1/2-14	1/2-14
12-12	3/4-14	3/4-14
16-16	1-11	1-11

AVAILABILITY

» Steel

3861

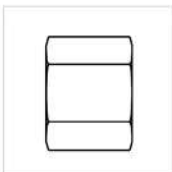

JIS Cap (30° Seat BSPP Thread)

SHAPE

Cap

Dash Size	Female JIS
04	1/4-19
06	3/8-19
08	1/2-14
12	3/4-14
16	1-11
20	1 1/4-11
24	1 1/2-11
32	2-11

AVAILABILITY

» Steel

JIS Plug (30° Seat BSPP Thread)

SHAPE

Plug

Dash Size	Male JIS
04	1/4-19
06	3/8-19
08	1/2-14
12	3/4-14
16	1-11
20	1 1/4-11
24	1 1/2-11
32	2-11

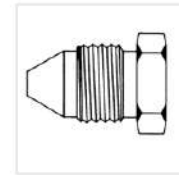
**3862**

AVAILABILITY

» Steel

JIS Sealing Seat

SHAPE

Straight

Dash Size	Male JIS
04	1/4-19
06	3/8-19
08	1/2-14
12	3/4-14
16	1-11
20	1 1/4-11
24	1 1/2-11

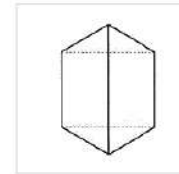
**3863**

AVAILABILITY

» Steel

JIC - JIS (30° Seat BSPP Thread)

SHAPE

Straight

Dash Size	Male JIC	Male JIS
04-04	7/16-20	1/4-19
06-06	9/16-18	3/8-19
08-08	3/4-16	1/2-14
12-12	1 1/16-12	3/4-14

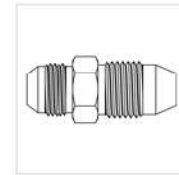
**3864**

AVAILABILITY

» Steel

JIS Union (30° Seat BSPP Thread)

SHAPE

Straight

Dash Size	Male JIS	Male JIS
04-04	1/4-19	1/4-19
06-06	3/8-19	3/8-19
08-08	1/2-14	1/2-14
12-12	3/4-14	3/4-14

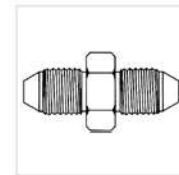
**3866**

AVAILABILITY

» Steel

3871

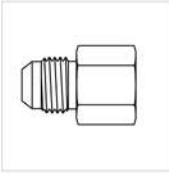
**JIC - JIS Solid (30° Seat BSPP Thread)**

SHAPE

Straight

Dash Size	Male JIC	Female JIS
04-04	7/16-20	1/4-19
06-04	9/16-18	1/4-19
06-06	9/16-18	3/8-19
08-06	3/4-16	3/8-19
08-08	3/4-16	1/2-14
12-12	1 1/16-12	3/4-14
16-16	1 5/16-12	1-11
20-20	1 5/8-12	1 1/4-11
24-24	1 7/8-12	1 1/2-11
32-32	2 1/2-12	2-11

AVAILABILITY

» Steel

7861

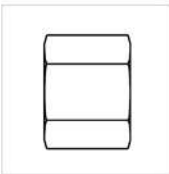
**Komatsu Cap (30° Seat Metric Thread)**

SHAPE

Cap

Dash Size	Female Komatsu
14	M14X1.5
18	M18X1.5
22	M22X1.5
24	M24X1.5
30	M30X1.5
33	M33X1.5

AVAILABILITY

» Steel

7862

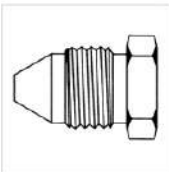
**Komatsu Plug (30° Seat Metric Thread)**

SHAPE

Plug

Dash Size	Male Komatsu
14	M14X1.5
18	M18X1.5
22	M22X1.5
24	M24X1.5
30	M30X1.5
33	M33X1.5

AVAILABILITY

» Steel

7865

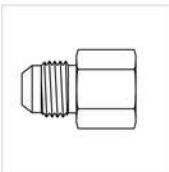
**JIC - Komatsu (30° Seat Metric Thread)**

SHAPE

Straight

Dash Size	Male JIC	Female Komatsu
04-14	7/16-20	M14X1.5
06-18	9/16-18	M18X1.5
08-22	3/4-16	M22X1.5
10-24	7/8-14	M24X1.5
12-30	1 1/16-12	M30X1.5
16-33	1 5/16-12	M33X1.5

AVAILABILITY

» Steel

Komatsu Union (30° Seat Metric Thread)

SHAPE

Straight

Dash Size	Male Komatsu	Male Komatsu
14-14	M14X1.5	M14X1.5
18-18	M18X1.5	M18X1.5
22-22	M22X1.5	M22X1.5
24-24	M24X1.5	M24X1.5
30-30	M30X1.5	M30X1.5
33-33	M33X1.5	M33X1.5

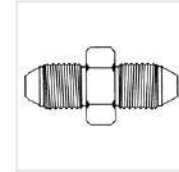
**7868**

AVAILABILITY

» Steel

JIC - Komatsu (30° Seat Metric Thread)

SHAPE

Straight

Dash Size	Male JIC	Male Komatsu
04-14	7/16-20	M14X1.5
06-16	9/16-18	M16X1.5
06-18	9/16-18	M18X1.5
08-22	3/4-16	M22X1.5
10-24	7/8-14	M24X1.5
12-30	1 1/16-12	M30X1.5
16-33	1 5/16-12	M33X1.5

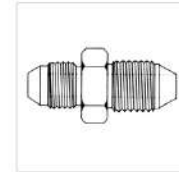
**7869**

AVAILABILITY

» Steel

Metric Compression Fittings

MC6000

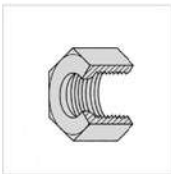

Metric Compression Coupling Nut

SHAPE

Nut

Dash Size	Female Metric Compression
LL04	LL04 (8x1.0)
LL06	LL06 (10x1.0)
LL08	LL08 (12x1.0)
L06	L06 (12x1.5)
L08	L08 (14x1.5)
L10	L10 (16x1.5)
L12	L12 (18x1.5)
L15	L15 (22x1.5)
L18	L18 (26x1.5)
L22	L22 (30x2.0)
L28	L28 (36x2.0)
L35	L35 (45x2.0)
L42	L42 (52x2.0)
S06	S06 (14x1.5)
S08	S08 (16x1.5)
S10	S10 (18x1.5)
S12	S12 (20x1.5)
S14	S14 (22x1.5)
S16	S16 (24x1.5)
S20	S20 (30x2.0)
S25	S25 (36x2.0)
S30	S30 (42x2.0)
S38	S38 (52x2.0)

AVAILABILITY

» Steel

MC6001



Metric Compression Bite Ring

SHAPE

Ferrule

Dash Size	Metric Compression Bite Ring
LL04	4mm
LL06	6mm
LL08	8mm
L06	6mm
L08	8mm
L10	10mm
L12	12mm
L15	15mm
L18	18mm
L22	22mm
L28	28mm
L35	35mm
L42	42mm
S06	6mm
S08	8mm
S10	10mm
S12	12mm

AVAILABILITY

» Steel

Dash Size	Metric Compression Bite Ring
S14	14mm
S16	16mm
S20	20mm
S25	25mm
S30	30mm
S38	38mm

MC6001

▼ continued

Metric Compression Bulkhead Nut

SHAPE

Nut

Dash Size	Female Metric Compression
L06	L06 (12x1.5)
L08	L08 (14x1.5)
L10	L10 (16x1.5)
L12	L12 (18x1.5)
L15	L15 (22x1.5)
L18	L18 (26x1.5)
L22	L22 (30x2.0)
L28	L28 (36x2.0)
L35	L35 (45x2.0)
L42	L42 (52x2.0)
S06	S06 (14x1.5)
S08	S08 (16x1.5)
S10	S10 (18x1.5)
S12	S12 (20x1.5)
S14	S14 (22x1.5)
S16	S16 (24x1.5)
S20	S20 (30x2.0)
S25	S25 (36x2.0)
S30	S30 (42x2.0)
S38	S38 (52x2.0)

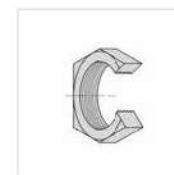
**MC6002**

AVAILABILITY

» Steel

Metric Compression Tube Plug

SHAPE

Plug

Dash Size	Male Metric Compression
L06	L06 (12x1.5)
L08	L08 (14x1.5)
L10	L10 (16x1.5)
L12	L12 (18x1.5)
L15	L15 (22x1.5)
L18	L18 (26x1.5)
L22	L22 (30x2.0)
L28	L28 (36x2.0)
L35	L35 (45x2.0)
L42	L42 (52x2.0)
S06	S06 (14x1.5)
S08	S08 (16x1.5)
S10	S10 (18x1.5)
S12	S12 (20x1.5)
S14	S14 (22x1.5)

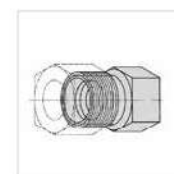
**MC6003**

AVAILABILITY

» Steel

▼ MC6003 continues

MC6003

▼ continued

Dash Size	Male Metric Compression
S16	S16 (24x1.5)
S20	S20 (30x2.0)
S25	S25 (36x2.0)
S30	S30 (42x2.0)
S38	S38 (52x2.0)

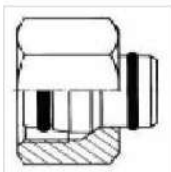
MC6004**Metric Compression Tube Cap**

SHAPE

Cap

Dash Size	Female Metric Compression
L06	L06 (12x1.5)
L08	L08 (14x1.5)
L10	L10 (16x1.5)
L12	L12 (18x1.5)
L15	L15 (22x1.5)
L18	L18 (26x1.5)
L22	L22 (30x2.0)
L28	L28 (36x2.0)
L35	L35 (45x2.0)
L42	L42 (52x2.0)
S06	S06 (14x1.5)
S08	S08 (16x1.5)
S10	S10 (18x1.5)
S12	S12 (20x1.5)
S14	S14 (22x1.5)
S16	S16 (24x1.5)
S20	S20 (30x2.0)
S25	S25 (36x2.0)
S30	S30 (42x2.0)
S38	S38 (52x2.0)

AVAILABILITY

» Steel

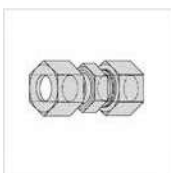
MC6020**Metric Compression Union Straight**

SHAPE

Straight

Dash Size	Male Metric Compression	Male Metric Compression
LL04-LL04	LL04 (8x1.0)	LL04 (8x1.0)
LL06-LL06	LL06 (10x1.0)	LL06 (10x1.0)
LL08-LL08	LL08 (12x1.0)	LL08 (12x1.0)
L06-L06	L06 (12x1.5)	L06 (12x1.5)
L08-L08	L08 (14x1.5)	L08 (14x1.5)
L10-L10	L10 (16x1.5)	L10 (16x1.5)
L12-L12	L12 (18x1.5)	L12 (18x1.5)
L15-L15	L15 (22x1.5)	L15 (22x1.5)
L18-L18	L18 (26x1.5)	L18 (26x1.5)
L22-L22	L22 (30x2.0)	L22 (30x2.0)
L28-L28	L28 (36x2.0)	L28 (36x2.0)
L35-L35	L35 (45x2.0)	L35 (45x2.0)
L42-L42	L42 (52x2.0)	L42 (52x2.0)
S06-S06	S06 (14x1.5)	S06 (14x1.5)
S08-S08	S08 (16x1.5)	S08 (16x1.5)
S10-S10	S10 (18x1.5)	S10 (18x1.5)

AVAILABILITY

» Steel

Dash Size	Male Metric Compression	Male Metric Compression
S12-S12	S12 (20x1.5)	S12 (20x1.5)
S14-S14	S14 (22x1.5)	S14 (22x1.5)
S16-S16	S16 (24x1.5)	S16 (24x1.5)
S20-S20	S20 (30x2.0)	S20 (30x2.0)
S25-S25	S25 (36x2.0)	S25 (36x2.0)
S30-S30	S30 (42x2.0)	S30 (42x2.0)
S38-S38	S38 (52x2.0)	S38 (52x2.0)

MC6020
▼ continued

Metric Compression Union Elbow 90°

SHAPE

90 degree elbow

Dash Size	Male Metric Compression	Male Metric Compression
LL04-LL04	LL04 (8x1.0)	LL04 (8x1.0)
LL06-LL06	LL06 (10x1.0)	LL06 (10x1.0)
LL08-LL08	LL08 (12x1.0)	LL08 (12x1.0)
L06-L06	L06 (12x1.5)	L06 (12x1.5)
L08-L08	L08 (14x1.5)	L08 (14x1.5)
L10-L10	L10 (16x1.5)	L10 (16x1.5)
L12-L12	L12 (18x1.5)	L12 (18x1.5)
L15-L15	L15 (22x1.5)	L15 (22x1.5)
L18-L18	L18 (26x1.5)	L18 (26x1.5)
L22-L22	L22 (30x2.0)	L22 (30x2.0)
L28-L28	L28 (36x2.0)	L28 (36x2.0)
L35-L35	L35 (45x2.0)	L35 (45x2.0)
L42-L42	L42 (52x2.0)	L42 (52x2.0)
S06-S06	S06 (14x1.5)	S06 (14x1.5)
S08-S08	S08 (16x1.5)	S08 (16x1.5)
S10-S10	S10 (18x1.5)	S10 (18x1.5)
S12-S12	S12 (20x1.5)	S12 (20x1.5)
S14-S14	S14 (22x1.5)	S14 (22x1.5)
S16-S16	S16 (24x1.5)	S16 (24x1.5)
S20-S20	S20 (30x2.0)	S20 (30x2.0)
S25-S25	S25 (36x2.0)	S25 (36x2.0)
S30-S30	S30 (42x2.0)	S30 (42x2.0)
S38-S38	S38 (52x2.0)	S38 (52x2.0)

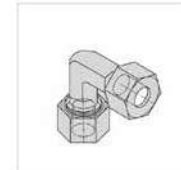

MC6021

AVAILABILITY

» Steel

MC6022

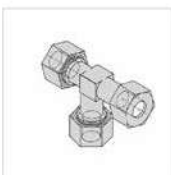

Metric Compression Union Tee

SHAPE

Tee

Dash Size	Male Metric Compression	Male Metric Compression	Male Metric Compression
LL04-LL04-LL04	LL04 (8x1.0)	LL04 (8x1.0)	LL04 (8x1.0)
LL06-LL06-LL06	LL06 (10x1.0)	LL06 (10x1.0)	LL06 (10x1.0)
LL08-LL08-LL08	LL08 (12x1.0)	LL08 (12x1.0)	LL08 (12x1.0)
L06-L06-L06	L06 (12x1.5)	L06 (12x1.5)	L06 (12x1.5)
L08-L08-L08	L08 (14x1.5)	L08 (14x1.5)	L08 (14x1.5)
L10-L10-L10	L10 (16x1.5)	L10 (16x1.5)	L10 (16x1.5)
L12-L12-L12	L12 (18x1.5)	L12 (18x1.5)	L12 (18x1.5)
L15-L15-L15	L15 (22x1.5)	L15 (22x1.5)	L15 (22x1.5)
L18-L18-L18	L18 (26x1.5)	L18 (26x1.5)	L18 (26x1.5)
L22-L22-L22	L22 (30x2.0)	L22 (30x2.0)	L22 (30x2.0)
L28-L28-L28	L28 (36x2.0)	L28 (36x2.0)	L28 (36x2.0)
L35-L35-L35	L35 (45x2.0)	L35 (45x2.0)	L35 (45x2.0)
L42-L42-L42	L42 (52x2.0)	L42 (52x2.0)	L42 (52x2.0)
S06-S06-S06	S06 (14x1.5)	S06 (14x1.5)	S06 (14x1.5)
S08-S08-S08	S08 (16x1.5)	S08 (16x1.5)	S08 (16x1.5)
S10-S10-S10	S10 (18x1.5)	S10 (18x1.5)	S10 (18x1.5)
S12-S12-S12	S12 (20x1.5)	S12 (20x1.5)	S12 (20x1.5)
S14-S14-S14	S14 (22x1.5)	S14 (22x1.5)	S14 (22x1.5)
S16-S16-S16	S16 (24x1.5)	S16 (24x1.5)	S16 (24x1.5)
S20-S20-S20	S20 (30x2.0)	S20 (30x2.0)	S20 (30x2.0)
S25-S25-S25	S25 (36x2.0)	S25 (36x2.0)	S25 (36x2.0)
S30-S30-S30	S30 (42x2.0)	S30 (42x2.0)	S30 (42x2.0)
S38-S38-S38	S38 (52x2.0)	S38 (52x2.0)	S38 (52x2.0)

AVAILABILITY

» Steel

MC6023

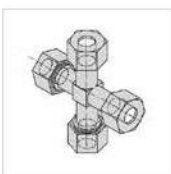

Metric Compression Union Cross

SHAPE

Cross

Dash Size	Male Metric Compression	Male Metric Compression	Male Metric Compression	Male Metric Compression
L06-L06-L06-L06	L06 (12x1.5)	L06 (12x1.5)	L06 (12x1.5)	L06 (12x1.5)
L08-L08-L08-L08	L08 (14x1.5)	L08 (14x1.5)	L08 (14x1.5)	L08 (14x1.5)
L10-L10-L10-L10	L10 (16x1.5)	L10 (16x1.5)	L10 (16x1.5)	L10 (16x1.5)
L12-L12-L12-L12	L12 (18x1.5)	L12 (18x1.5)	L12 (18x1.5)	L12 (18x1.5)
L15-L15-L15-L15	L15 (22x1.5)	L15 (22x1.5)	L15 (22x1.5)	L15 (22x1.5)
L18-L18-L18-L18	L18 (26x1.5)	L18 (26x1.5)	L18 (26x1.5)	L18 (26x1.5)
L22-L22-L22-L22	L22 (30x2.0)	L22 (30x2.0)	L22 (30x2.0)	L22 (30x2.0)
L28-L28-L28-L28	L28 (36x2.0)	L28 (36x2.0)	L28 (36x2.0)	L28 (36x2.0)
L35-L35-L35-L35	L35 (45x2.0)	L35 (45x2.0)	L35 (45x2.0)	L35 (45x2.0)
L42-L42-L42-L42	L42 (52x2.0)	L42 (52x2.0)	L42 (52x2.0)	L42 (52x2.0)
S06-S06-S06-S06	S06 (14x1.5)	S06 (14x1.5)	S06 (14x1.5)	S06 (14x1.5)
S08-S08-S08-S08	S08 (16x1.5)	S08 (16x1.5)	S08 (16x1.5)	S08 (16x1.5)
S10-S10-S10-S10	S10 (18x1.5)	S10 (18x1.5)	S10 (18x1.5)	S10 (18x1.5)
S12-S12-S12-S12	S12 (20x1.5)	S12 (20x1.5)	S12 (20x1.5)	S12 (20x1.5)
S14-S14-S14-S14	S14 (22x1.5)	S14 (22x1.5)	S14 (22x1.5)	S14 (22x1.5)
S16-S16-S16-S16	S16 (24x1.5)	S16 (24x1.5)	S16 (24x1.5)	S16 (24x1.5)
S20-S20-S20-S20	S20 (30x2.0)	S20 (30x2.0)	S20 (30x2.0)	S20 (30x2.0)
S25-S25-S25-S25	S25 (36x2.0)	S25 (36x2.0)	S25 (36x2.0)	S25 (36x2.0)
S30-S30-S30-S30	S30 (42x2.0)	S30 (42x2.0)	S30 (42x2.0)	S30 (42x2.0)
S38-S38-S38-S38	S38 (52x2.0)	S38 (52x2.0)	S38 (52x2.0)	S38 (52x2.0)

AVAILABILITY

» Steel

Metric Compression Union Bulkhead

SHAPE

Straight

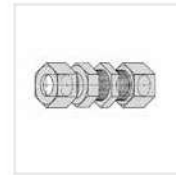

MC6026

AVAILABILITY

» Steel

Dash Size	Male Metric Compression	Male Metric Compression
L06-L06	L06 (12x1.5)	L06 (12x1.5)
L08-L08	L08 (14x1.5)	L08 (14x1.5)
L10-L10	L10 (16x1.5)	L10 (16x1.5)
L12-L12	L12 (18x1.5)	L12 (18x1.5)
L15-L15	L15 (22x1.5)	L15 (22x1.5)
L18-L18	L18 (26x1.5)	L18 (26x1.5)
L22-L22	L22 (30x2.0)	L22 (30x2.0)
L28-L28	L28 (36x2.0)	L28 (36x2.0)
L35-L35	L35 (45x2.0)	L35 (45x2.0)
L42-L42	L42 (52x2.0)	L42 (52x2.0)
S06-S06	S06 (14x1.5)	S06 (14x1.5)
S08-S08	S08 (16x1.5)	S08 (16x1.5)
S10-S10	S10 (18x1.5)	S10 (18x1.5)
S12-S12	S12 (20x1.5)	S12 (20x1.5)
S14-S14	S14 (22x1.5)	S14 (22x1.5)
S16-S16	S16 (24x1.5)	S16 (24x1.5)
S20-S20	S20 (30x2.0)	S20 (30x2.0)
S25-S25	S25 (36x2.0)	S25 (36x2.0)
S30-S30	S30 (42x2.0)	S30 (42x2.0)
S38-S38	S38 (52x2.0)	S38 (52x2.0)

Metric Compression Union Bulkhead Elbow 90°

SHAPE

90 degree elbow



MC6027

AVAILABILITY

» Steel

Dash Size	Male Metric Compression	Male Metric Compression
L06-L06	L06 (12x1.5)	L06 (12x1.5)
L08-L08	L08 (14x1.5)	L08 (14x1.5)
L10-L10	L10 (16x1.5)	L10 (16x1.5)
L12-L12	L12 (18x1.5)	L12 (18x1.5)
L15-L15	L15 (22x1.5)	L15 (22x1.5)
L18-L18	L18 (26x1.5)	L18 (26x1.5)
L22-L22	L22 (30x2.0)	L22 (30x2.0)
L28-L28	L28 (36x2.0)	L28 (36x2.0)
L35-L35	L35 (45x2.0)	L35 (45x2.0)
L42-L42	L42 (52x2.0)	L42 (52x2.0)
S06-S06	S06 (14x1.5)	S06 (14x1.5)
S08-S08	S08 (16x1.5)	S08 (16x1.5)
S10-S10	S10 (18x1.5)	S10 (18x1.5)
S12-S12	S12 (20x1.5)	S12 (20x1.5)
S14-S14	S14 (22x1.5)	S14 (22x1.5)
S16-S16	S16 (24x1.5)	S16 (24x1.5)
S20-S20	S20 (30x2.0)	S20 (30x2.0)
S25-S25	S25 (36x2.0)	S25 (36x2.0)
S30-S30	S30 (42x2.0)	S30 (42x2.0)
S38-S38	S38 (52x2.0)	S38 (52x2.0)

MC6050

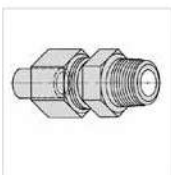

Metric Compression Male Stud Coupling - BSPT

SHAPE

Straight

Dash Size	Male Metric Compression	Male British Pipe Tapered
LL04-02	LL04 (8x1.0)	1/8-28
LL06-02	LL06 (10x1.0)	1/8-28
LL08-02	LL08 (12x1.0)	1/8-28
L06-02	L06 (12x1.5)	1/8-28
L08-04	L08 (14x1.5)	1/4-19
L10-04	L10 (16x1.5)	1/4-19
L12-06	L12 (18x1.5)	3/8-19
L12-08	L12 (18x1.5)	1/2-14
L15-08	L15 (22x1.5)	1/2-14
L18-08	L18 (26x1.5)	1/2-14
L22-12	L22 (30x2.0)	3/4-14
S06-04	S06 (14x1.5)	1/4-19
S08-04	S08 (16x1.5)	1/4-19
S10-06	S10 (18x1.5)	3/8-19
S12-06	S12 (20x1.5)	3/8-19
S14-08	S14 (22x1.5)	1/2-14
S16-08	S16 (24x1.5)	1/2-14
S20-12	S20 (30x2.0)	3/4-14

AVAILABILITY

» Steel

MC6051

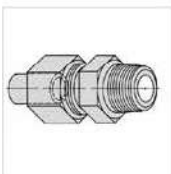

Metric Compression Male Stud Coupling - NPT

SHAPE

Straight

Dash Size	Male Metric Compression	Male Pipe
LL04-02	LL04 (8x1.0)	1/8-27
LL06-02	LL06 (10x1.0)	1/8-27
LL08-02	LL08 (12x1.0)	1/8-27
L06-02	L06 (12x1.5)	1/8-27
L06-04	L06 (12x1.5)	1/4-18
L06-06	L06 (12x1.5)	3/8-18
L06-08	L06 (12x1.5)	1/2-14
L08-02	L08 (14x1.5)	1/8-27
L08-04	L08 (14x1.5)	1/4-18
L08-06	L08 (14x1.5)	3/8-18
L08-08	L08 (14x1.5)	1/2-14
L10-02	L10 (16x1.5)	1/8-27
L10-04	L10 (16x1.5)	1/4-18
L10-06	L10 (16x1.5)	3/8-18
L10-08	L10 (16x1.5)	1/2-14
L10-12	L10 (16x1.5)	3/4-14
L12-04	L12 (18x1.5)	1/4-18
L12-06	L12 (18x1.5)	3/8-18
L12-08	L12 (18x1.5)	1/2-14
L15-06	L15 (22x1.5)	3/8-18
L15-08	L15 (22x1.5)	1/2-14
L15-12	L15 (22x1.5)	3/4-14
L15-16	L15 (22x1.5)	1-11 1/2
L18-06	L18 (26x1.5)	3/8-18
L18-08	L18 (26x1.5)	1/2-14
L18-12	L18 (26x1.5)	3/4-14
L18-16	L18 (26x1.5)	1-11 1/2

AVAILABILITY

» Steel

Dash Size	Male Metric Compression	Male Pipe
L22-06	L22 (30x2.0)	3/8-18
L22-08	L22 (30x2.0)	1/2-14
L22-12	L22 (30x2.0)	3/4-14
L22-16	L22 (30x2.0)	1-11 1/2
L28-12	L28 (36x2.0)	3/4-14
L28-16	L28 (36x2.0)	1-11 1/2
L28-20	L28 (36x2.0)	1 1/4-11 1/2
L35-20	L35 (45x2.0)	1 1/4-11 1/2
L42-20	L42 (52x2.0)	1 1/4-11 1/2
L42-24	L42 (52x2.0)	1 1/2-11 1/2
S06-02	S06 (14x1.5)	1/8-27
S06-04	S06 (14x1.5)	1/4-18
S06-06	S06 (14x1.5)	3/8-18
S06-08	S06 (14x1.5)	1/2-14
S08-04	S08 (16x1.5)	1/4-18
S08-06	S08 (16x1.5)	3/8-18
S08-08	S08 (16x1.5)	1/2-14
S10-04	S10 (18x1.5)	1/4-18
S10-06	S10 (18x1.5)	3/8-18
S10-08	S10 (18x1.5)	1/2-14
S10-12	S10 (18x1.5)	3/4-14
S12-04	S12 (20x1.5)	1/4-18
S12-06	S12 (20x1.5)	3/8-18
S12-08	S12 (20x1.5)	1/2-14
S12-12	S12 (20x1.5)	3/4-14
S14-08	S14 (22x1.5)	1/2-14
S14-12	S14 (22x1.5)	3/4-14
S14-16	S14 (22x1.5)	1-11 1/2
S16-06	S16 (24x1.5)	3/8-18
S16-08	S16 (24x1.5)	1/2-14
S16-12	S16 (24x1.5)	3/4-14
S16-16	S16 (24x1.5)	1-11 1/2
S20-08	S20 (30x2.0)	1/2-14
S20-12	S20 (30x2.0)	3/4-14
S20-16	S20 (30x2.0)	1-11 1/2
S25-12	S25 (36x2.0)	3/4-14
S25-16	S25 (36x2.0)	1-11 1/2
S25-20	S25 (36x2.0)	1 1/4-11 1/2
S25-24	S25 (36x2.0)	1 1/2-11 1/2
S30-16	S30 (42x2.0)	1-11 1/2
S30-20	S30 (42x2.0)	1 1/4-11 1/2
S30-24	S30 (42x2.0)	1 1/2-11 1/2
S38-16	S38 (52x2.0)	1-11 1/2
S38-24	S38 (52x2.0)	1 1/2-11 1/2

MC6051

▼ continued

MC6052

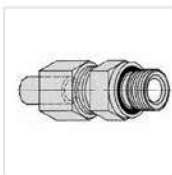

Metric Compression Male Stud Coupling - BSPP (with captive seal)

SHAPE

Straight

AVAILABILITY

» Steel

Dash Size	Male Metric Compression	Male British Pipe Parallel
L06-02	L06 (12x1.5)	1/8-28
L06-04	L06 (12x1.5)	1/4-19
L08-02	L08 (14x1.5)	1/8-28
L08-04	L08 (14x1.5)	1/4-19
L08-06	L08 (14x1.5)	3/8-19
L08-08	L08 (14x1.5)	1/2-14
L10-04	L10 (16x1.5)	1/4-19
L10-06	L10 (16x1.5)	3/8-19
L10-08	L10 (16x1.5)	1/2-14
L12-04	L12 (18x1.5)	1/4-19
L12-06	L12 (18x1.5)	3/8-19
L12-08	L12 (18x1.5)	1/2-14
L12-12	L12 (18x1.5)	3/4-14
L15-06	L15 (22x1.5)	3/8-19
L15-08	L15 (22x1.5)	1/2-14
L15-12	L15 (22x1.5)	3/4-14
L18-06	L18 (26x1.5)	3/8-19
L18-08	L18 (26x1.5)	1/2-14
L18-12	L18 (26x1.5)	3/4-14
L22-08	L22 (30x2.0)	1/2-14
L22-12	L22 (30x2.0)	3/4-14
L22-16	L22 (30x2.0)	1-11
L28-12	L28 (36x2.0)	3/4-14
L28-16	L28 (36x2.0)	1-11
L35-16	L35 (45x2.0)	1-11
L35-20	L35 (45x2.0)	1 1/4-11
L42-24	L42 (52x2.0)	1 1/2-11
S06-04	S06 (14x1.5)	1/4-19
S06-08	S06 (14x1.5)	1/2-14
S08-04	S08 (16x1.5)	1/4-19
S08-06	S08 (16x1.5)	3/8-19
S10-04	S10 (18x1.5)	1/4-19
S10-06	S10 (18x1.5)	3/8-19
S10-08	S10 (18x1.5)	1/2-14
S12-04	S12 (20x1.5)	1/4-19
S12-06	S12 (20x1.5)	3/8-19
S12-08	S12 (20x1.5)	1/2-14
S14-08	S14 (22x1.5)	1/2-14
S16-06	S16 (24x1.5)	3/8-19
S16-08	S16 (24x1.5)	1/2-14
S16-12	S16 (24x1.5)	3/4-14
S20-08	S20 (30x2.0)	1/2-14
S20-12	S20 (30x2.0)	3/4-14
S25-08	S25 (36x2.0)	1/2-14
S25-12	S25 (36x2.0)	3/4-14
S25-16	S25 (36x2.0)	1-11
S30-16	S30 (42x2.0)	1-11
S30-20	S30 (42x2.0)	1 1/4-11
S38-20	S38 (52x2.0)	1 1/4-11
S38-24	S38 (52x2.0)	1 1/2-11

Metric Compression Male Stud Coupling - Metric (with captive seal)

SHAPE

Straight

Dash Size	Male Metric Compression	Male Metric
L06-10	L06 (12x1.5)	M10X1.0
L06-12	L06 (12x1.5)	M12X1.5
L08-12	L08 (14x1.5)	M12X1.5
L08-14	L08 (14x1.5)	M14X1.5
L08-16	L08 (14x1.5)	M16X1.5
L08-18	L08 (14x1.5)	M18X1.5
L08-22	L08 (14x1.5)	M22X1.5
L10-14	L10 (16x1.5)	M14X1.5
L10-16	L10 (16x1.5)	M16X1.5
L10-18	L10 (16x1.5)	M18X1.5
L10-22	L10 (16x1.5)	M22X1.5
L12-14	L12 (18x1.5)	M14X1.5
L12-16	L12 (18x1.5)	M16X1.5
L12-18	L12 (18x1.5)	M18X1.5
L12-22	L12 (18x1.5)	M22X1.5
L15-16	L15 (22x1.5)	M16X1.5
L15-18	L15 (22x1.5)	M18X1.5
L15-22	L15 (22x1.5)	M22X1.5
L18-18	L18 (26x1.5)	M18X1.5
L18-22	L18 (26x1.5)	M22X1.5
L22-22	L22 (30x2.0)	M22X1.5
L22-26	L22 (30x2.0)	M26X1.5
L28-33	L28 (36x2.0)	M33X2.0
L35-42	L35 (45x2.0)	M42X2.0
L42-48	L42 (52x2.0)	M48X2.0
S06-12	S06 (14x1.5)	M12X1.5
S08-14	S08 (16x1.5)	M14X1.5
S10-16	S10 (18x1.5)	M16X1.5
S12-18	S12 (20x1.5)	M18X1.5
S12-22	S12 (20x1.5)	M22X1.5
S14-20	S14 (22x1.5)	M20X1.5
S16-22	S16 (24x1.5)	M22X1.5
S20-27	S20 (30x2.0)	M27X2.0
S25-33	S25 (36x2.0)	M33X2.0
S30-42	S30 (42x2.0)	M42X2.0
S38-48	S38 (52x2.0)	M48X2.0

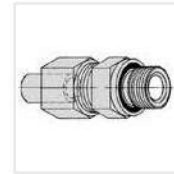

MC6053

AVAILABILITY

» Steel

Metric Compression Female Stud Coupling - BSPP

SHAPE

Straight

Dash Size	Male Metric Compression	Female British Pipe Parallel
L06-02	L06 (12x1.5)	1/8-28
L06-04	L06 (12x1.5)	1/4-19
L08-04	L08 (14x1.5)	1/4-19
L08-06	L08 (14x1.5)	3/8-19
L08-08	L08 (14x1.5)	1/2-14
L10-04	L10 (16x1.5)	1/4-19
L10-06	L10 (16x1.5)	3/8-19

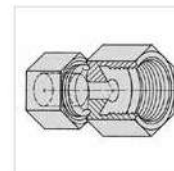

MC6062

AVAILABILITY

» Steel

▼ MC6062 continues

MC6062

▼ continued

Dash Size	Male Metric Compression	Female British Pipe Parallel
L10-08	L10 (16x1.5)	1/2-14
L12-06	L12 (18x1.5)	3/8-19
L12-08	L12 (18x1.5)	1/2-14
L15-06	L15 (22x1.5)	3/8-19
L15-08	L15 (22x1.5)	1/2-14
L18-06	L18 (26x1.5)	3/8-19
L18-08	L18 (26x1.5)	1/2-14
L18-12	L18 (26x1.5)	3/4-14
L22-12	L22 (30x2.0)	3/4-14
L22-16	L22 (30x2.0)	1-11
L28-16	L28 (36x2.0)	1-11
L35-20	L35 (45x2.0)	1 1/4-11
L42-24	L42 (52x2.0)	1 1/2-11
S06-04	S06 (14x1.5)	1/4-19
S08-04	S08 (16x1.5)	1/4-19
S10-06	S10 (18x1.5)	3/8-19
S10-08	S10 (18x1.5)	1/2-14
S12-06	S12 (20x1.5)	3/8-19
S12-08	S12 (20x1.5)	1/2-14
S14-08	S14 (22x1.5)	1/2-14
S16-08	S16 (24x1.5)	1/2-14
S20-12	S20 (30x2.0)	3/4-14
S25-16	S25 (36x2.0)	1-11
S30-20	S30 (42x2.0)	1 1/4-11
S38-24	S38 (52x2.0)	1 1/2-11

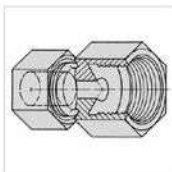
MC6063**Metric Compression Female Stud Coupling - Metric**

SHAPE

Straight

Dash Size	Male Metric Compression	Female Metric
L06-10	L06 (12x1.5)	M10X1.0
L08-12	L08 (14x1.5)	M12X1.5
L08-14	L08 (14x1.5)	M14X1.5
L10-12	L10 (16x1.5)	M12X1.5
L10-14	L10 (16x1.5)	M14X1.5
L12-16	L12 (18x1.5)	M16X1.5
L15-18	L15 (22x1.5)	M18X1.5
L18-22	L18 (26x1.5)	M22X1.5
L22-26	L22 (30x2.0)	M26X1.5
L28-33	L28 (36x2.0)	M33X2.0
S06-12	S06 (14x1.5)	M12X1.5
S08-14	S08 (16x1.5)	M14X1.5
S10-16	S10 (18x1.5)	M16X1.5
S12-18	S12 (20x1.5)	M18X1.5
S14-20	S14 (22x1.5)	M20X1.5
S16-22	S16 (24x1.5)	M22X1.5
S20-27	S20 (30x2.0)	M27X2.0
S25-33	S25 (36x2.0)	M33X2.0

AVAILABILITY

» Steel

Metric Compression Male Stud Elbow - BSPT

SHAPE

90 degree elbow

Dash Size	Male Metric Compression	Male British Pipe Tapered
LL04-02	LL04 (8x1.0)	1/8-28
LL06-02	LL06 (10x1.0)	1/8-28
LL08-02	LL08 (12x1.0)	1/8-28
L06-02	L06 (12x1.5)	1/8-28
L08-04	L08 (14x1.5)	1/4-19
L08-06	L08 (14x1.5)	3/8-19
L10-04	L10 (16x1.5)	1/4-19
L12-04	L12 (18x1.5)	1/4-19
L12-06	L12 (18x1.5)	3/8-19
L15-08	L15 (22x1.5)	1/2-14
L18-08	L18 (26x1.5)	1/2-14
S06-04	S06 (14x1.5)	1/4-19
S08-04	S08 (16x1.5)	1/4-19
S10-06	S10 (18x1.5)	3/8-19
S12-06	S12 (20x1.5)	3/8-19
S14-08	S14 (22x1.5)	1/2-14
S16-08	S16 (24x1.5)	1/2-14

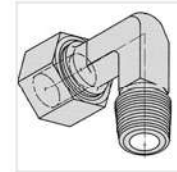

MC6070

AVAILABILITY

» Steel

Metric Compression Male Stud Elbow 90° - NPT

SHAPE

90 degree elbow

Dash Size	Male Metric Compression	Male Pipe
LL04-02	LL04 (8x1.0)	1/8-27
LL06-02	LL06 (10x1.0)	1/8-27
LL08-02	LL08 (12x1.0)	1/8-27
L06-02	L06 (12x1.5)	1/8-27
L06-04	L06 (12x1.5)	1/4-18
L08-04	L08 (14x1.5)	1/4-18
L10-04	L10 (16x1.5)	1/4-18
L10-06	L10 (16x1.5)	3/8-18
L12-04	L12 (18x1.5)	1/4-18
L12-06	L12 (18x1.5)	3/8-18
L12-08	L12 (18x1.5)	1/2-14
L15-08	L15 (22x1.5)	1/2-14
L18-08	L18 (26x1.5)	1/2-14
L22-12	L22 (30x2.0)	3/4-14
L28-16	L28 (36x2.0)	1-11 1/2
L35-20	L35 (45x2.0)	1 1/4-11 1/2
L42-24	L42 (52x2.0)	1 1/2-11 1/2
S06-04	S06 (14x1.5)	1/4-18
S08-04	S08 (16x1.5)	1/4-18
S10-06	S10 (18x1.5)	3/8-18
S12-04	S12 (20x1.5)	1/4-18
S12-06	S12 (20x1.5)	3/8-18
S12-08	S12 (20x1.5)	1/2-14
S14-08	S14 (22x1.5)	1/2-14
S16-08	S16 (24x1.5)	1/2-14
S20-12	S20 (30x2.0)	3/4-14
S25-16	S25 (36x2.0)	1-11 1/2
S30-20	S30 (42x2.0)	1 1/4-11 1/2
S38-24	S38 (52x2.0)	1 1/2-11 1/2

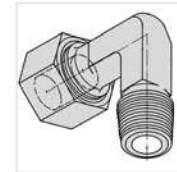

MC6071

AVAILABILITY

» Steel

MC6080

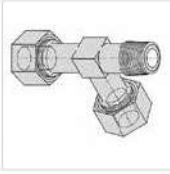

Metric Compression Male Stud Run Tee - BSPT

SHAPE

Tee

Dash Size	Male Metric Compression	Male British Pipe Tapered	Male Metric Compression
LL04-02-LL04	LL04 (8x1.0)	1/8-28	LL04 (8x1.0)
LL06-02-LL06	LL06 (10x1.0)	1/8-28	LL06 (10x1.0)
LL08-02-LL08	LL08 (12x1.0)	1/8-28	LL08 (12x1.0)
L06-02-L06	L06 (12x1.5)	1/8-28	L06 (12x1.5)
L08-04-L08	L08 (14x1.5)	1/4-19	L08 (14x1.5)
L10-04-L10	L10 (16x1.5)	1/4-19	L10 (16x1.5)
L12-06-L12	L12 (18x1.5)	3/8-19	L12 (18x1.5)
L15-08-L15	L15 (22x1.5)	1/2-14	L15 (22x1.5)
L18-08-L18	L18 (26x1.5)	1/2-14	L18 (26x1.5)
S06-04-S06	S06 (14x1.5)	1/4-19	S06 (14x1.5)
S08-04-S08	S08 (16x1.5)	1/4-19	S08 (16x1.5)
S10-06-S10	S10 (18x1.5)	3/8-19	S10 (18x1.5)
S12-06-S12	S12 (20x1.5)	3/8-19	S12 (20x1.5)
S14-08-S14	S14 (22x1.5)	1/2-14	S14 (22x1.5)
S16-08-S16	S16 (24x1.5)	1/2-14	S16 (24x1.5)

AVAILABILITY

» Steel

MC6081

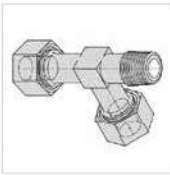

Metric Compression Male Stud Run Tee - NPT

SHAPE

Tee

Dash Size	Male Metric Compression	Male Pipe	Male Metric Compression
LL04-02-LL04	LL04 (8x1.0)	1/8-27	LL04 (8x1.0)
LL06-02-LL06	LL06 (10x1.0)	1/8-27	LL06 (10x1.0)
LL08-02-LL08	LL08 (12x1.0)	1/8-27	LL08 (12x1.0)
L06-02-L06	L06 (12x1.5)	1/8-27	L06 (12x1.5)
L08-04-L08	L08 (14x1.5)	1/4-18	L08 (14x1.5)
L10-04-L10	L10 (16x1.5)	1/4-18	L10 (16x1.5)
L12-06-L12	L12 (18x1.5)	3/8-18	L12 (18x1.5)
L15-08-L15	L15 (22x1.5)	1/2-14	L15 (22x1.5)
L18-08-L18	L18 (26x1.5)	1/2-14	L18 (26x1.5)
L22-12-L22	L22 (30x2.0)	3/4-14	L22 (30x2.0)
L28-16-L28	L28 (36x2.0)	1-11 1/2	L28 (36x2.0)
L35-20-L35	L35 (45x2.0)	1 1/4-11 1/2	L35 (45x2.0)
L42-24-L42	L42 (52x2.0)	1 1/2-11 1/2	L42 (52x2.0)
S06-04-S06	S06 (14x1.5)	1/4-18	S06 (14x1.5)
S08-04-S08	S08 (16x1.5)	1/4-18	S08 (16x1.5)
S10-06-S10	S10 (18x1.5)	3/8-18	S10 (18x1.5)
S12-06-S12	S12 (20x1.5)	3/8-18	S12 (20x1.5)
S14-08-S14	S14 (22x1.5)	1/2-14	S14 (22x1.5)
S16-08-S16	S16 (24x1.5)	1/2-14	S16 (24x1.5)
S20-12-S20	S20 (30x2.0)	3/4-14	S20 (30x2.0)
S25-16-S25	S25 (36x2.0)	1-11 1/2	S25 (36x2.0)
S30-20-S30	S30 (42x2.0)	1 1/4-11 1/2	S30 (42x2.0)
S38-24-S38	S38 (52x2.0)	1 1/2-11 1/2	S38 (52x2.0)

AVAILABILITY

» Steel

Metric Compression Male Stud Branch Tee - BSPT

SHAPE

Tee

Dash Size	Male Metric Compression	Male Metric Compression	Male British Pipe Tapered
LL04-LL04-02	LL04 (8x1.0)	LL04 (8x1.0)	1/8-28
LL06-LL06-02	LL06 (10x1.0)	LL06 (10x1.0)	1/8-28
LL08-LL08-08	LL08 (12x1.0)	LL08 (12x1.0)	1/2-14
L06-L06-02	L06 (12x1.5)	L06 (12x1.5)	1/8-28
L08-L08-04	L08 (14x1.5)	L08 (14x1.5)	1/4-19
L10-L10-04	L10 (16x1.5)	L10 (16x1.5)	1/4-19
L12-L12-04	L12 (18x1.5)	L12 (18x1.5)	1/4-19
L12-L12-06	L12 (18x1.5)	L12 (18x1.5)	3/8-19
L15-L15-08	L15 (22x1.5)	L15 (22x1.5)	1/2-14
L18-L18-08	L18 (26x1.5)	L18 (26x1.5)	1/2-14
S06-S06-04	S06 (14x1.5)	S06 (14x1.5)	1/4-19
S08-S08-04	S08 (16x1.5)	S08 (16x1.5)	1/4-19
S10-S10-06	S10 (18x1.5)	S10 (18x1.5)	3/8-19
S12-S12-06	S12 (20x1.5)	S12 (20x1.5)	3/8-19
S14-S14-08	S14 (22x1.5)	S14 (22x1.5)	1/2-14
S16-S16-08	S16 (24x1.5)	S16 (24x1.5)	1/2-14

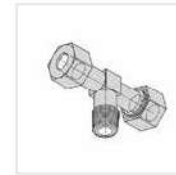

MC6090

AVAILABILITY

» Steel

Metric Compression Male Stud Branch Tee - NPT

SHAPE

Tee

Dash Size	Male Metric Compression	Male Metric Compression	Male Pipe
LL04-LL04-02	LL04 (8x1.0)	LL04 (8x1.0)	1/8-27
LL06-LL06-02	LL06 (10x1.0)	LL06 (10x1.0)	1/8-27
LL08-LL08-02	LL08 (12x1.0)	LL08 (12x1.0)	1/8-27
L06-L06-02	L06 (12x1.5)	L06 (12x1.5)	1/8-27
L08-L08-04	L08 (14x1.5)	L08 (14x1.5)	1/4-18
L10-L10-04	L10 (16x1.5)	L10 (16x1.5)	1/4-18
L12-L12-06	L12 (18x1.5)	L12 (18x1.5)	3/8-18
L15-L15-08	L15 (22x1.5)	L15 (22x1.5)	1/2-14
L18-L18-08	L18 (26x1.5)	L18 (26x1.5)	1/2-14
L22-L22-12	L22 (30x2.0)	L22 (30x2.0)	3/4-14
L28-L28-16	L28 (36x2.0)	L28 (36x2.0)	1-11 1/2
L35-L35-20	L35 (45x2.0)	L35 (45x2.0)	1 1/4-11 1/2
L42-L42-24	L42 (52x2.0)	L42 (52x2.0)	1 1/2-11 1/2
S06-S06-04	S06 (14x1.5)	S06 (14x1.5)	1/4-18
S08-S08-04	S08 (16x1.5)	S08 (16x1.5)	1/4-18
S10-S10-06	S10 (18x1.5)	S10 (18x1.5)	3/8-18
S12-S12-06	S12 (20x1.5)	S12 (20x1.5)	3/8-18
S14-S14-08	S14 (22x1.5)	S14 (22x1.5)	1/2-14
S16-S16-08	S16 (24x1.5)	S16 (24x1.5)	1/2-14
S20-S20-12	S20 (30x2.0)	S20 (30x2.0)	3/4-14
S25-S25-16	S25 (36x2.0)	S25 (36x2.0)	1-11 1/2
S30-S30-20	S30 (42x2.0)	S30 (42x2.0)	1 1/4-11 1/2
S38-S38-24	S38 (52x2.0)	S38 (52x2.0)	1 1/2-11 1/2

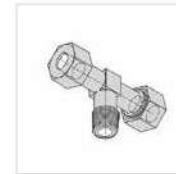

MC6091

AVAILABILITY

» Steel

MC6100

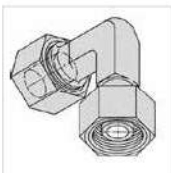

Metric Compression Swivel Elbow 90°

SHAPE

90 degree elbow

Dash Size	Male Metric Compression	Female Metric Compression
L06-L06	L06 (12x1.5)	L06 (12x1.5)
L08-L08	L08 (14x1.5)	L08 (14x1.5)
L10-L10	L10 (16x1.5)	L10 (16x1.5)
L12-L12	L12 (18x1.5)	L12 (18x1.5)
L15-L15	L15 (22x1.5)	L15 (22x1.5)
L18-L18	L18 (26x1.5)	L18 (26x1.5)
L22-L22	L22 (30x2.0)	L22 (30x2.0)
L28-L28	L28 (36x2.0)	L28 (36x2.0)
L35-L35	L35 (45x2.0)	L35 (45x2.0)
L42-L42	L42 (52x2.0)	L42 (52x2.0)
S06-S06	S06 (14x1.5)	S06 (14x1.5)
S08-S08	S08 (16x1.5)	S08 (16x1.5)
S10-S10	S10 (18x1.5)	S10 (18x1.5)
S12-S12	S12 (20x1.5)	S12 (20x1.5)
S14-S14	S14 (22x1.5)	S14 (22x1.5)
S16-S16	S16 (24x1.5)	S16 (24x1.5)
S20-S20	S20 (30x2.0)	S20 (30x2.0)
S25-S25	S25 (36x2.0)	S25 (36x2.0)
S30-S30	S30 (42x2.0)	S30 (42x2.0)
S38-S38	S38 (52x2.0)	S38 (52x2.0)

AVAILABILITY

» Steel

MC6101

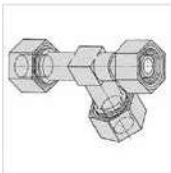

Metric Compression Swivel Run Tee

SHAPE

Tee

Dash Size	Male Metric Compression	Female Metric Compression	Male Metric Compression
L06-L06-L06	L06 (12x1.5)	L06 (12x1.5)	L06 (12x1.5)
L08-L08-L08	L08 (14x1.5)	L08 (14x1.5)	L08 (14x1.5)
L10-L10-L10	L10 (16x1.5)	L10 (16x1.5)	L10 (16x1.5)
L12-L12-L12	L12 (18x1.5)	L12 (18x1.5)	L12 (18x1.5)
L15-L15-L15	L15 (22x1.5)	L15 (22x1.5)	L15 (22x1.5)
L18-L18-L18	L18 (26x1.5)	L18 (26x1.5)	L18 (26x1.5)
L22-L22-L22	L22 (30x2.0)	L22 (30x2.0)	L22 (30x2.0)
L28-L28-L28	L28 (36x2.0)	L28 (36x2.0)	L28 (36x2.0)
L35-L35-L35	L35 (45x2.0)	L35 (45x2.0)	L35 (45x2.0)
L42-L42-L42	L42 (52x2.0)	L42 (52x2.0)	L42 (52x2.0)
S06-S06-S06	S06 (14x1.5)	S06 (14x1.5)	S06 (14x1.5)
S08-S08-S08	S08 (16x1.5)	S08 (16x1.5)	S08 (16x1.5)
S10-S10-S10	S10 (18x1.5)	S10 (18x1.5)	S10 (18x1.5)
S12-S12-S12	S12 (20x1.5)	S12 (20x1.5)	S12 (20x1.5)
S14-S14-S14	S14 (22x1.5)	S14 (22x1.5)	S14 (22x1.5)
S16-S16-S16	S16 (24x1.5)	S16 (24x1.5)	S16 (24x1.5)
S20-S20-S20	S20 (30x2.0)	S20 (30x2.0)	S20 (30x2.0)
S25-S25-S25	S25 (36x2.0)	S25 (36x2.0)	S25 (36x2.0)
S30-S30-S30	S30 (42x2.0)	S30 (42x2.0)	S30 (42x2.0)
S38-S38-S38	S38 (52x2.0)	S38 (52x2.0)	S38 (52x2.0)

AVAILABILITY

» Steel

Metric Compression Swivel Branch Tee

SHAPE

Tee

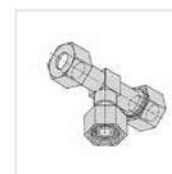

MC6102

AVAILABILITY

» Steel

Dash Size	Male Metric Compression	Male Metric Compression	Female Metric Compression
L06-L06-L06	L06 (12x1.5)	L06 (12x1.5)	L06 (12x1.5)
L08-L08-L08	L08 (14x1.5)	L08 (14x1.5)	L08 (14x1.5)
L10-L10-L10	L10 (16x1.5)	L10 (16x1.5)	L10 (16x1.5)
L12-L12-L12	L12 (18x1.5)	L12 (18x1.5)	L12 (18x1.5)
L15-L15-L15	L15 (22x1.5)	L15 (22x1.5)	L15 (22x1.5)
L18-L18-L18	L18 (26x1.5)	L18 (26x1.5)	L18 (26x1.5)
L22-L22-L22	L22 (30x2.0)	L22 (30x2.0)	L22 (30x2.0)
L28-L28-L28	L28 (36x2.0)	L28 (36x2.0)	L28 (36x2.0)
L35-L35-L35	L35 (45x2.0)	L35 (45x2.0)	L35 (45x2.0)
L42-L42-L42	L42 (52x2.0)	L42 (52x2.0)	L42 (52x2.0)
S06-S06-S06	S06 (14x1.5)	S06 (14x1.5)	S06 (14x1.5)
S08-S08-S08	S08 (16x1.5)	S08 (16x1.5)	S08 (16x1.5)
S10-S10-S10	S10 (18x1.5)	S10 (18x1.5)	S10 (18x1.5)
S12-S12-S12	S12 (20x1.5)	S12 (20x1.5)	S12 (20x1.5)
S14-S14-S14	S14 (22x1.5)	S14 (22x1.5)	S14 (22x1.5)
S16-S16-S16	S16 (24x1.5)	S16 (24x1.5)	S16 (24x1.5)
S20-S20-S20	S20 (30x2.0)	S20 (30x2.0)	S20 (30x2.0)
S25-S25-S25	S25 (36x2.0)	S25 (36x2.0)	S25 (36x2.0)
S30-S30-S30	S30 (42x2.0)	S30 (42x2.0)	S30 (42x2.0)
S38-S38-S38	S38 (52x2.0)	S38 (52x2.0)	S38 (52x2.0)

Metric Compression Reducer

SHAPE

Straight

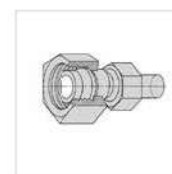

MC6110

AVAILABILITY

» Steel

Dash Size	Female Metric Compression	Male Metric Compression
L08-L06	L08 (14x1.5)	L06 (12x1.5)
L10-L06	L10 (16x1.5)	L06 (12x1.5)
L10-L08	L10 (16x1.5)	L08 (14x1.5)
L12-L06	L12 (18x1.5)	L06 (12x1.5)
L12-L08	L12 (18x1.5)	L08 (14x1.5)
L12-L10	L12 (18x1.5)	L10 (16x1.5)
L15-L06	L15 (22x1.5)	L06 (12x1.5)
L15-L08	L15 (22x1.5)	L08 (14x1.5)
L15-L10	L15 (22x1.5)	L10 (16x1.5)
L15-L12	L15 (22x1.5)	L12 (18x1.5)
L18-L06	L18 (26x1.5)	L06 (12x1.5)
L18-L08	L18 (26x1.5)	L08 (14x1.5)
L18-L10	L18 (26x1.5)	L10 (16x1.5)
L18-L12	L18 (26x1.5)	L12 (18x1.5)
L18-L15	L18 (26x1.5)	L15 (22x1.5)
L22-L06	L22 (30x2.0)	L06 (12x1.5)
L22-L08	L22 (30x2.0)	L08 (14x1.5)
L22-L10	L22 (30x2.0)	L10 (16x1.5)
L22-L12	L22 (30x2.0)	L12 (18x1.5)
L22-L15	L22 (30x2.0)	L15 (22x1.5)
L22-L18	L22 (30x2.0)	L18 (26x1.5)
L28-L06	L28 (36x2.0)	L06 (12x1.5)
L28-L08	L28 (36x2.0)	L08 (14x1.5)
L28-L10	L28 (36x2.0)	L10 (16x1.5)

▼ MC6110 continues

MC6110
 ▼ continued

Dash Size	Female Metric Compression	Male Metric Compression
L28-L12	L28 (36x2.0)	L12 (18x1.5)
L28-L15	L28 (36x2.0)	L15 (22x1.5)
L28-L18	L28 (36x2.0)	L18 (26x1.5)
L28-L22	L28 (36x2.0)	L22 (30x2.0)
L35-L06	L35 (45x2.0)	L06 (12x1.5)
L35-L08	L35 (45x2.0)	L08 (14x1.5)
L35-L10	L35 (45x2.0)	L10 (16x1.5)
L35-L12	L35 (45x2.0)	L12 (18x1.5)
L35-L15	L35 (45x2.0)	L15 (22x1.5)
L35-L18	L35 (45x2.0)	L18 (26x1.5)
L35-L22	L35 (45x2.0)	L22 (30x2.0)
L35-L28	L35 (45x2.0)	L28 (36x2.0)
L42-L10	L42 (52x2.0)	L10 (16x1.5)
L42-L12	L42 (52x2.0)	L12 (18x1.5)
L42-L15	L42 (52x2.0)	L15 (22x1.5)
L42-L18	L42 (52x2.0)	L18 (26x1.5)
L42-L22	L42 (52x2.0)	L22 (30x2.0)
L42-L28	L42 (52x2.0)	L28 (36x2.0)
L42-L35	L42 (52x2.0)	L35 (45x2.0)
S08-S06	S08 (16x1.5)	S06 (14x1.5)
S10-S06	S10 (18x1.5)	S06 (14x1.5)
S10-S08	S10 (18x1.5)	S08 (16x1.5)
S12-S06	S12 (20x1.5)	S06 (14x1.5)
S12-S08	S12 (20x1.5)	S08 (16x1.5)
S12-S10	S12 (20x1.5)	S10 (18x1.5)
S14-S06	S14 (22x1.5)	S06 (14x1.5)
S14-S08	S14 (22x1.5)	S08 (16x1.5)
S14-S10	S14 (22x1.5)	S10 (18x1.5)
S14-S12	S14 (22x1.5)	S12 (20x1.5)
S16-S06	S16 (24x1.5)	S06 (14x1.5)
S16-S08	S16 (24x1.5)	S08 (16x1.5)
S16-S10	S16 (24x1.5)	S10 (18x1.5)
S16-S12	S16 (24x1.5)	S12 (20x1.5)
S16-S14	S16 (24x1.5)	S14 (22x1.5)
S20-S06	S20 (30x2.0)	S06 (14x1.5)
S20-S08	S20 (30x2.0)	S08 (16x1.5)
S20-S10	S20 (30x2.0)	S10 (18x1.5)
S20-S12	S20 (30x2.0)	S12 (20x1.5)
S20-S16	S20 (30x2.0)	S16 (24x1.5)
S25-S06	S25 (36x2.0)	S06 (14x1.5)
S25-S08	S25 (36x2.0)	S08 (16x1.5)
S25-S10	S25 (36x2.0)	S10 (18x1.5)
S25-S12	S25 (36x2.0)	S12 (20x1.5)
S25-S16	S25 (36x2.0)	S16 (24x1.5)
S25-S20	S25 (36x2.0)	S20 (30x2.0)
S30-S06	S30 (42x2.0)	S06 (14x1.5)
S30-S08	S30 (42x2.0)	S08 (16x1.5)
S30-S10	S30 (42x2.0)	S10 (18x1.5)
S30-S12	S30 (42x2.0)	S12 (20x1.5)
S30-S16	S30 (42x2.0)	S16 (24x1.5)
S30-S20	S30 (42x2.0)	S20 (30x2.0)
S30-S25	S30 (42x2.0)	S25 (36x2.0)
S38-S06	S38 (52x2.0)	S06 (14x1.5)
S38-S08	S38 (52x2.0)	S08 (16x1.5)
S38-S10	S38 (52x2.0)	S10 (18x1.5)

Dash Size	Female Metric Compression	Male Metric Compression
S38-S12	S38 (52x2.0)	S12 (20x1.5)
S38-S16	S38 (52x2.0)	S16 (24x1.5)
S38-S20	S38 (52x2.0)	S20 (30x2.0)
S38-S25	S38 (52x2.0)	S25 (36x2.0)
S38-S30	S38 (52x2.0)	S30 (42x2.0)

MC6110

▼ continued

Metric Compression Stud/Standpipe - NPT

SHAPE

Straight

Dash Size	Female Metric Compression	Male Pipe
L06-02	L06 (12x1.5)	1/8-27
L08-04	L08 (14x1.5)	1/4-18
L10-04	L10 (16x1.5)	1/4-18
L10-06	L10 (16x1.5)	3/8-18
L12-06	L12 (18x1.5)	3/8-18
L15-08	L15 (22x1.5)	1/2-14
L18-08	L18 (26x1.5)	1/2-14
L22-12	L22 (30x2.0)	3/4-14
L28-16	L28 (36x2.0)	1-11 1/2
L35-20	L35 (45x2.0)	1 1/4-11 1/2
L42-24	L42 (52x2.0)	1 1/2-11 1/2
S06-04	S06 (14x1.5)	1/4-18
S08-04	S08 (16x1.5)	1/4-18
S10-06	S10 (18x1.5)	3/8-18
S12-06	S12 (20x1.5)	3/8-18
S14-08	S14 (22x1.5)	1/2-14
S16-08	S16 (24x1.5)	1/2-14
S20-12	S20 (30x2.0)	3/4-14
S25-16	S25 (36x2.0)	1-11 1/2
S30-20	S30 (42x2.0)	1 1/4-11 1/2
S38-24	S38 (52x2.0)	1 1/2-11 1/2

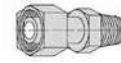
**MC6121****AVAILABILITY**

» Steel

Metric Compression Stud/Standpipe - BSPP

SHAPE

Straight

Dash Size	Female Metric Compression	Male British Pipe Parallel
L06-02	L06 (12x1.5)	1/8-28
L08-04	L08 (14x1.5)	1/4-19
L10-04	L10 (16x1.5)	1/4-19
L12-06	L12 (18x1.5)	3/8-19
L15-08	L15 (22x1.5)	1/2-14
L18-08	L18 (26x1.5)	1/2-14
L22-12	L22 (30x2.0)	3/4-14
L28-16	L28 (36x2.0)	1-11
L35-20	L35 (45x2.0)	1 1/4-11
L42-24	L42 (52x2.0)	1 1/2-11
S06-04	S06 (14x1.5)	1/4-19
S08-04	S08 (16x1.5)	1/4-19
S10-06	S10 (18x1.5)	3/8-19
S12-06	S12 (20x1.5)	3/8-19
S14-08	S14 (22x1.5)	1/2-14

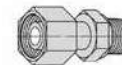
**MC6122****AVAILABILITY**

» Steel

▼ MC6122 continues

MC6122

▼ continued

Dash Size	Female Metric Compression	Male British Pipe Parallel
S16-08	S16 (24x1.5)	1/2-14
S20-12	S20 (30x2.0)	3/4-14
S25-16	S25 (36x2.0)	1-11
S30-20	S30 (42x2.0)	1 1/4-11
S38-24	S38 (52x2.0)	1 1/2-11

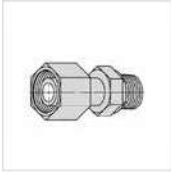
MC6123**Metric Compression Stud/Standpipe - Metric**

SHAPE

Straight

Dash Size	Female Metric Compression	Male Metric
L06-10	L06 (12x1.5)	M10X1.0
L08-12	L08 (14x1.5)	M12X1.5
L10-14	L10 (16x1.5)	M14X1.5
L12-16	L12 (18x1.5)	M16X1.5
L15-18	L15 (22x1.5)	M18X1.5
L18-22	L18 (26x1.5)	M22X1.5
L22-26	L22 (30x2.0)	M26X1.5
L28-33	L28 (36x2.0)	M33X2.0
L35-42	L35 (45x2.0)	M42X2.0
L42-48	L42 (52x2.0)	M48X2.0
S06-12	S06 (14x1.5)	M12X1.5
S08-14	S08 (16x1.5)	M14X1.5
S10-16	S10 (18x1.5)	M16X1.5
S12-18	S12 (20x1.5)	M18X1.5
S14-20	S14 (22x1.5)	M20X1.5
S16-22	S16 (24x1.5)	M22X1.5
S20-27	S20 (30x2.0)	M27X2.0
S25-33	S25 (36x2.0)	M33X2.0
S30-42	S30 (42x2.0)	M42X2.0
S38-48	S38 (52x2.0)	M48X2.0

AVAILABILITY

» Steel

MC6132**Metric Compression Banjo - BSPP**

SHAPE

90 degree elbow

Dash Size	Male Metric Compression	Male British Pipe Parallel
LL04-02	LL04 (8x1.0)	1/8-28
LL06-02	LL06 (10x1.0)	1/8-28
LL08-02	LL08 (12x1.0)	1/8-28
L06-02	L06 (12x1.5)	1/8-28
L08-04	L08 (14x1.5)	1/4-19
L10-04	L10 (16x1.5)	1/4-19
L12-06	L12 (18x1.5)	3/8-19
L15-08	L15 (22x1.5)	1/2-14
L18-08	L18 (26x1.5)	1/2-14
L22-12	L22 (30x2.0)	3/4-14
S06-04	S06 (14x1.5)	1/4-19
S08-04	S08 (16x1.5)	1/4-19
S10-06	S10 (18x1.5)	3/8-19
S12-06	S12 (20x1.5)	3/8-19
S14-08	S14 (22x1.5)	1/2-14
S16-08	S16 (24x1.5)	1/2-14
S20-12	S20 (30x2.0)	3/4-14

AVAILABILITY

» Steel

Metric Compression Banjo - Metric

SHAPE

90 degree elbow

Dash Size	Male Metric Compression	Male Metric
LL04-08	LL04 (8x1.0)	M8X1.0
LL06-10	LL06 (10x1.0)	M10X1.0
LL08-10	LL08 (12x1.0)	M10X1.0
L06-10	L06 (12x1.5)	M10X1.0
L08-12	L08 (14x1.5)	M12X1.5
L10-14	L10 (16x1.5)	M14X1.5
L12-16	L12 (18x1.5)	M16X1.5
L15-18	L15 (22x1.5)	M18X1.5
L18-22	L18 (26x1.5)	M22X1.5
L22-26	L22 (30x2.0)	M26X1.5
S06-12	S06 (14x1.5)	M12X1.5
S08-14	S08 (16x1.5)	M14X1.5
S10-16	S10 (18x1.5)	M16X1.5
S12-18	S12 (20x1.5)	M18X1.5
S14-20	S14 (22x1.5)	M20X1.5
S16-22	S16 (24x1.5)	M22X1.5
S20-27	S20 (30x2.0)	M27X2.0

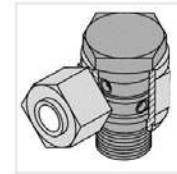

MC6133

AVAILABILITY

» Steel

Metric Compression Banjo - BSPP (Throttle Free)

SHAPE

90 degree elbow

Dash Size	Male Metric Compression	Male British Pipe Parallel
L06-02	L06 (12x1.5)	1/8-28
L08-04	L08 (14x1.5)	1/4-19
L10-04	L10 (16x1.5)	1/4-19
L12-06	L12 (18x1.5)	3/8-19
L15-08	L15 (22x1.5)	1/2-14
L18-08	L18 (26x1.5)	1/2-14
L22-12	L22 (30x2.0)	3/4-14
L28-16	L28 (36x2.0)	1-11
L35-20	L35 (45x2.0)	1 1/4-11
L42-24	L42 (52x2.0)	1 1/2-11
S06-04	S06 (14x1.5)	1/4-19
S08-04	S08 (16x1.5)	1/4-19
S10-06	S10 (18x1.5)	3/8-19
S12-06	S12 (20x1.5)	3/8-19
S14-08	S14 (22x1.5)	1/2-14
S16-08	S16 (24x1.5)	1/2-14
S20-12	S20 (30x2.0)	3/4-14
S25-16	S25 (36x2.0)	1-11
S30-20	S30 (42x2.0)	1 1/4-11
S38-24	S38 (52x2.0)	1 1/2-11

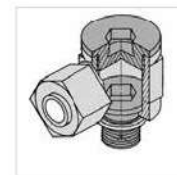

MC6142

AVAILABILITY

» Steel

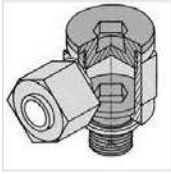
MC6143**Metric Compression Banjo - Metric (Throttle Free)**

SHAPE

90 degree elbow

Dash Size	Male Metric Compression	Male Metric
L06-10	L06 (12x1.5)	M10X1.0
L08-12	L08 (14x1.5)	M12X1.5
L10-14	L10 (16x1.5)	M14X1.5
L12-16	L12 (18x1.5)	M16X1.5
L15-18	L15 (22x1.5)	M18X1.5
L18-22	L18 (26x1.5)	M22X1.5
L22-26	L22 (30x2.0)	M26X1.5
L28-33	L28 (36x2.0)	M33X2.0
L35-42	L35 (45x2.0)	M42X2.0
L42-48	L42 (52x2.0)	M48X2.0
S06-12	S06 (14x1.5)	M12X1.5
S08-14	S08 (16x1.5)	M14X1.5
S10-16	S10 (18x1.5)	M16X1.5
S12-18	S12 (20x1.5)	M18X1.5
S14-20	S14 (22x1.5)	M20X1.5
S16-22	S16 (24x1.5)	M22X1.5
S20-27	S20 (30x2.0)	M27X2.0
S25-33	S25 (36x2.0)	M33X2.0
S30-42	S30 (42x2.0)	M42X2.0
S38-48	S38 (52x2.0)	M48X2.0

AVAILABILITY

» Steel

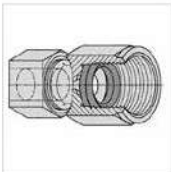
MC6152**Metric Compression Gauge Coupling - BSPP**

SHAPE

Straight

Dash Size	Male Metric Compression	Female British Pipe Parallel
L06-04	L06 (12x1.5)	1/4-19
L08-04	L08 (14x1.5)	1/4-19
L10-04	L10 (16x1.5)	1/4-19
L12-04	L12 (18x1.5)	1/4-19
S06-08	S06 (14x1.5)	1/2-14
S08-08	S08 (16x1.5)	1/2-14
S10-08	S10 (18x1.5)	1/2-14
S12-08	S12 (20x1.5)	1/2-14

AVAILABILITY

» Steel

Metric Compression Straight Union with Test Point

SHAPE

Tee

Dash Size	Male Metric Compression	Male Metric Compression	Male Test Point
L06-L06-M16X2.0	L06 (12x1.5)	L06 (12x1.5)	M16X2.0
L08-L08-M16X2.0	L08 (14x1.5)	L08 (14x1.5)	M16X2.0
L10-L10-M16X2.0	L10 (16x1.5)	L10 (16x1.5)	M16X2.0
L12-L12-M16X2.0	L12 (18x1.5)	L12 (18x1.5)	M16X2.0
L15-L15-M16X2.0	L15 (22x1.5)	L15 (22x1.5)	M16X2.0
L18-L18-M16X2.0	L18 (26x1.5)	L18 (26x1.5)	M16X2.0
L22-L22-M16X2.0	L22 (30x2.0)	L22 (30x2.0)	M16X2.0
L28-L28-M16X2.0	L28 (36x2.0)	L28 (36x2.0)	M16X2.0
L35-L35-M16X2.0	L35 (45x2.0)	L35 (45x2.0)	M16X2.0
L42-L42-M16X2.0	L42 (52x2.0)	L42 (52x2.0)	M16X2.0
S06-S06-M16X2.0	S06 (14x1.5)	S06 (14x1.5)	M16X2.0
S08-S08-M16X2.0	S08 (16x1.5)	S08 (16x1.5)	M16X2.0
S10-S10-M16X2.0	S10 (18x1.5)	S10 (18x1.5)	M16X2.0
S12-S12-M16X2.0	S12 (20x1.5)	S12 (20x1.5)	M16X2.0
S14-S14-M16X2.0	S14 (22x1.5)	S14 (22x1.5)	M16X2.0
S16-S16-M16X2.0	S16 (24x1.5)	S16 (24x1.5)	M16X2.0
S20-S20-M16X2.0	S20 (30x2.0)	S20 (30x2.0)	M16X2.0
S25-S25-M16X2.0	S25 (36x2.0)	S25 (36x2.0)	M16X2.0
S30-S30-M16X2.0	S30 (42x2.0)	S30 (42x2.0)	M16X2.0
S38-S38-M16X2.0	S38 (52x2.0)	S38 (52x2.0)	M16X2.0



MC6160

AVAILABILITY

» Steel

Thread Identification Kits

FTGK-98



Thread Identification Kit for Male Threads

APPLICATION	Male Threads
WEIGHT	4.8 lbs

Tompkins offers a Thread Identification Kit incorporating female-threaded gauges for use in identifying male threads. You get precise identification of both metric and BSP threads.

With 14 dual-threaded gauges for measuring 28 thread sizes, this precision-manufactured kit likewise guarantees ease and accuracy. Eliminate the costly guesswork of trying to compare your parts to fittings which often vary from specifications.

This kit includes:

- BSP thread gauges
- 1/8 - 28 BSP through 1 1/4 - 11
- Metric Thread Gauges
- M8 x 1.0 through M52 x 2.0
- Metric and BSP pitch gauges

AVAILABILITY

» Aluminum

MTGK-98



Thread Identification Kit for Female Threads

APPLICATION	Female Threads
WEIGHT	4.8 lbs

Tompkins offers a Thread Identification Kit incorporating male-threaded gauges for use in identifying female threads. You get precise identification of both metric and BSP threads.

This portable, compact kit features 14 dual-threaded gauges that allow you to measure 28 thread sizes quickly and accurately. Made from hardened anodized aluminum and labeled with laser-engraved sizes, these gauges are durable, yet lightweight and easy-to-read for a fast ID. All male thread gauges have internal chamfers to accommodate metric or BSP hose fittings with an inverted flare configuration.

This kit includes:

- BSP thread gauges
- 1/8 - 28 BSP through 1 1/4 - 11
- Metric Thread Gauges
- M8 x 1.0 through M52 x 2.0
- Metric and BSP pitch gauges

AVAILABILITY

» Aluminum



LIVE SWIVELS

LS-1501

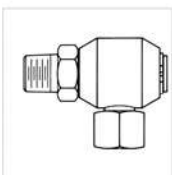

Pipe to NPSM Swivel Elbow 90°

Other sizes and configurations are available upon request.

SHAPE

90 degree elbow

Dash Size	Male Pipe	Female Pipe Swivel
04-04	1/4-18	1/4-18
04-06	1/4-18	3/8-18
06-04	3/8-18	1/4-18
06-06	3/8-18	3/8-18
08-08	1/2-14	1/2-14
12-12	3/4-14	3/4-14
16-16	1-11 1/2	1-11 1/2
20-20	1 1/4-11 1/2	1 1/4-11 1/2
24-24	1 1/2-11 1/2	1 1/2-11 1/2
32-32	2-11 1/2	2-11 1/2

AVAILABILITY

» Steel

LS-1502

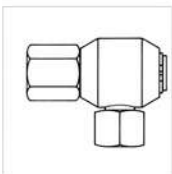

Pipe to NPSM Swivel Elbow 90°

Other sizes and configurations are available upon request.

SHAPE

90 degree elbow

Dash Size	Female Pipe	Female Pipe Swivel
04-04	1/4-18	1/4-18
06-04	3/8-18	1/4-18
06-06	3/8-18	3/8-18
08-08	1/2-14	1/2-14
12-12	3/4-14	3/4-14
16-16	1-11 1/2	1-11 1/2
20-20	1 1/4-11 1/2	1 1/4-11 1/2
24-24	1 1/2-11 1/2	1 1/2-11 1/2
32-32	2-11 1/2	2-11 1/2

AVAILABILITY

» Steel

LS-2403



MJIC to MJIC

Other sizes and configurations are available upon request.

SHAPE

Straight

Dash Size	Male JIC	Male JIC
06-06	9/16-18	9/16-18
08-08	3/4-16	3/4-16
12-12	1 1/16-12	1 1/16-12
16-16	1 5/16-12	1 5/16-12
20-20	1 5/8-12	1 5/8-12
24-24	1 7/8-12	1 7/8-12

AVAILABILITY

» Steel

JIC to Pipe

Other sizes and configurations are available upon request.

SHAPE

Straight

Dash Size	Male JIC	Male Pipe
06-04	9/16-18	1/4-18
06-06	9/16-18	3/8-18
08-06	3/4-16	3/8-18
08-08	3/4-16	1/2-14
10-08	7/8-14	1/2-14
12-12	1 1/16-12	3/4-14
16-16	1 5/16-12	1-11 1/2
20-20	1 5/8-12	1 1/4-11 1/2
24-24	1 7/8-12	1 1/2-11 1/2
32-32	2 1/2-12	2-11 1/2

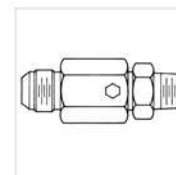

LS-2404

AVAILABILITY

» Steel

JIC to Pipe

Other sizes and configurations are available upon request.

SHAPE

Straight

Dash Size	Male JIC	Female Pipe
06-04	9/16-18	1/4-18
06-06	9/16-18	3/8-18
08-06	3/4-16	3/8-18
08-08	3/4-16	1/2-14
10-08	7/8-14	1/2-14
12-12	1 1/16-12	3/4-14
16-16	1 5/16-12	1-11 1/2
20-20	1 5/8-12	1 1/4-11 1/2
24-24	1 7/8-12	1 1/2-11 1/2
32-32	2 1/2-12	2-11 1/2

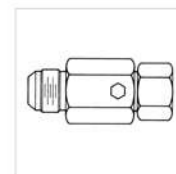

LS-2405

AVAILABILITY

» Steel

JIC to JIC

Other sizes and configurations are available upon request.

SHAPE

Straight

Dash Size	Male JIC	Female JIC
04-04	7/16-20	7/16-20
05-05	1/2-20	1/2-20
06-06	9/16-18	9/16-18
08-08	3/4-16	3/4-16
10-10	7/8-14	7/8-14
12-12	1 1/16-12	1 1/16-12
14-14	1 3/16-12	1 3/16-12
16-16	1 5/16-12	1 5/16-12
20-20	1 5/8-12	1 5/8-12
24-24	1 7/8-12	1 7/8-12
32-32	2 1/2-12	2 1/2-12

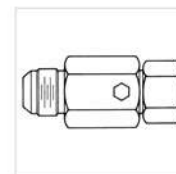

LS-2406

AVAILABILITY

» Steel

LS-2500



JIC to JIC Elbow 90°

Other sizes and configurations are available upon request.

SHAPE

90 degree elbow

Dash Size	Male JIC	Male JIC
04-04	7/16-20	7/16-20
06-06	9/16-18	9/16-18
08-08	3/4-16	3/4-16
10-10	7/8-14	7/8-14
12-12	1 1/16-12	1 1/16-12
16-16	1 5/16-12	1 5/16-12
20-20	1 5/8-12	1 5/8-12
24-24	1 7/8-12	1 7/8-12
32-32	2 1/2-12	2 1/2-12

AVAILABILITY

» Steel

LS-2501



JIC to Pipe Elbow 90°

Other sizes and configurations are available upon request.

SHAPE

90 degree elbow

Dash Size	Male JIC	Male Pipe
04-04	7/16-20	1/4-18
05-06	1/2-20	3/8-18
06-04	9/16-18	1/4-18
06-06	9/16-18	3/8-18
08-06	3/4-16	3/8-18
08-08	3/4-16	1/2-14
10-08	7/8-14	1/2-14
12-12	1 1/16-12	3/4-14
16-16	1 5/16-12	1-11 1/2
20-20	1 5/8-12	1 1/4-11 1/2
24-24	1 7/8-12	1 1/2-11 1/2
32-32	2 1/2-12	2-11 1/2

AVAILABILITY

» Steel

LS-2502

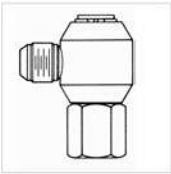

JIC to Pipe Elbow 90°

Other sizes and configurations are available upon request.

SHAPE

90 degree elbow

Dash Size	Male JIC	Female Pipe
05-06	1/2-20	3/8-18
06-04	9/16-18	1/4-18
06-06	9/16-18	3/8-18
08-06	3/4-16	3/8-18
08-08	3/4-16	1/2-14
10-08	7/8-14	1/2-14
12-12	1 1/16-12	3/4-14
16-16	1 5/16-12	1-11 1/2
20-20	1 5/8-12	1 1/4-11 1/2
24-24	1 7/8-12	1 1/2-11 1/2
32-32	2 1/2-12	2-11 1/2

AVAILABILITY

» Steel

Pipe to Pipe

Other sizes and configurations are available upon request.

SHAPE

Straight

Dash Size	Female Pipe	Female Pipe
04-04	1/4-18	1/4-18
06-06	3/8-18	3/8-18
08-08	1/2-14	1/2-14
12-12	3/4-14	3/4-14
16-16	1-11 1/2	1-11 1/2
20-20	1 1/4-11 1/2	1 1/4-11 1/2
24-24	1 1/2-11 1/2	1 1/2-11 1/2
32-32	2-11 1/2	2-11 1/2

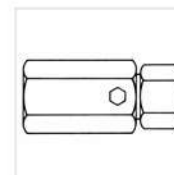

LS-5000

AVAILABILITY

» Steel

Pipe to Pipe

Other sizes and configurations are available upon request.

SHAPE

Straight

Dash Size	Male Pipe	Female Pipe
04-04	1/4-18	1/4-18
06-06	3/8-18	3/8-18
08-08	1/2-14	1/2-14
12-12	3/4-14	3/4-14
16-16	1-11 1/2	1-11 1/2
20-20	1 1/4-11 1/2	1 1/4-11 1/2
24-24	1 1/2-11 1/2	1 1/2-11 1/2
32-32	2-11 1/2	2-11 1/2

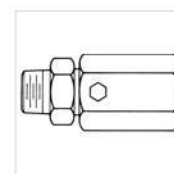

LS-5405

AVAILABILITY

» Steel

Pipe to Pipe Elbow 90°

Other sizes and configurations are available upon request.

SHAPE

90 degree elbow

Dash Size	Male Pipe	Male Pipe
04-04	1/4-18	1/4-18
06-06	3/8-18	3/8-18
08-08	1/2-14	1/2-14
12-12	3/4-14	3/4-14
16-16	1-11 1/2	1-11 1/2
20-20	1 1/4-11 1/2	1 1/4-11 1/2
24-24	1 1/2-11 1/2	1 1/2-11 1/2
32-32	2-11 1/2	2-11 1/2

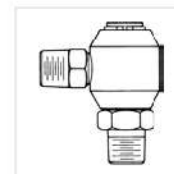

LS-5500

AVAILABILITY

» Steel

LS-5502

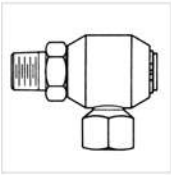

Pipe to Pipe Elbow 90°

Other sizes and configurations are available upon request.

SHAPE

90 degree elbow

Dash Size	Male Pipe	Female Pipe
04-04	1/4-18	1/4-18
04-06	1/4-18	3/8-18
06-04	3/8-18	1/4-18
06-06	3/8-18	3/8-18
08-08	1/2-14	1/2-14
12-12	3/4-14	3/4-14
16-16	1-11 1/2	1-11 1/2
20-20	1 1/4-11 1/2	1 1/4-11 1/2
24-24	1 1/2-11 1/2	1 1/2-11 1/2
32-32	2-11 1/2	2-11 1/2

AVAILABILITY

» Steel

LS-5504

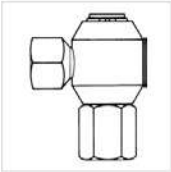

Pipe to Pipe Elbow 90°

Other sizes and configurations are available upon request.

SHAPE

90 degree elbow

Dash Size	Female Pipe	Female Pipe
04-04	1/4-18	1/4-18
06-06	3/8-18	3/8-18
08-08	1/2-14	1/2-14
12-12	3/4-14	3/4-14
16-16	1-11 1/2	1-11 1/2
20-20	1 1/4-11 1/2	1 1/4-11 1/2
24-24	1 1/2-11 1/2	1 1/2-11 1/2
32-32	2-11 1/2	2-11 1/2

AVAILABILITY

» Steel

LS-6400



JIC to O-Ring

Other sizes and configurations are available upon request.

SHAPE

Straight

Dash Size	Male JIC	Male O-Ring
04-04	7/16-20	7/16-20
06-06	9/16-18	9/16-18
10-10	7/8-14	7/8-14
12-12	1 1/16-12	1 1/16-12
16-16	1 5/16-12	1 5/16-12

AVAILABILITY

» Steel

JIC to O-Ring Elbow 90°

Other sizes and configurations are available upon request.

SHAPE

90 degree elbow

Dash Size	Male JIC	Male O-Ring
04-04	7/16-20	7/16-20
06-05	9/16-18	1/2-20
06-06	9/16-18	9/16-18
06-08	9/16-18	3/4-16
08-06	3/4-16	9/16-18
08-08	3/4-16	3/4-16
08-10	3/4-16	7/8-14
10-10	7/8-14	7/8-14
10-12	7/8-14	1 1/16-12
12-12	1 1/16-12	1 1/16-12
16-16	1 5/8-12	1 5/8-12
20-20	1 5/8-12	1 5/8-12
24-24	1 7/8-12	1 7/8-12
32-32	2 1/2-12	2 1/2-12



LS-6801

AVAILABILITY

» Steel

Pipe to O-Ring Elbow 90°

Other sizes and configurations are available upon request.

SHAPE

90 degree elbow

Dash Size	Male Pipe	Male O-Ring
04-06	1/4-18	9/16-18
06-06	3/8-18	9/16-18
08-10	1/2-14	7/8-14
12-12	3/4-14	1 1/16-12
16-16	1-11 1/2	1 5/16-12
20-20	1 1/4-11 1/2	1 5/8-12
24-24	1 1/2-11 1/2	1 7/8-12

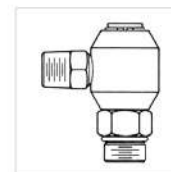

LS-6806

AVAILABILITY

» Steel

O-Ring to O-Ring Elbow 90 degree

Other sizes and configurations are available upon request.

SHAPE

90 degree elbow

Dash Size	Male O-Ring	Female O-Ring
06-06	9/16-18	9/16-18
08-08	3/4-16	3/4-16
12-12	1 1/16-12	1 1/16-12

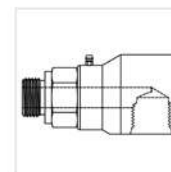

LS-6815

AVAILABILITY

» Steel

LS-6901

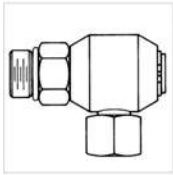

O-Ring to Pipe Swivel Elbow 90°

Other sizes and configurations are available upon request.

SHAPE

90 degree elbow

AVAILABILITY

» Steel

Dash Size	Male O-Ring	Female Pipe Swivel
04-06	7/16-20	3/8-18
05-04	1/2-20	1/4-18
06-04	9/16-18	1/4-18
06-06	9/16-18	3/8-18
06-08	9/16-18	1/2-14
08-06	3/4-16	3/8-18
08-08	3/4-16	1/2-14
10-08	7/8-14	1/2-14
12-12	1 1/16-12	3/4-14
16-16	1 5/16-12	1-11 1/2
20-20	1 5/8-12	1 1/4-11 1/2
24-24	1 7/8-12	1 1/2-11 1/2
32-32	2 1/2-12	2-11 1/2

LS-FF2403

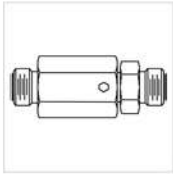

O-Ring Face Seal to O-Ring Face Seal

Other sizes and configurations are available upon request.

SHAPE

Straight

AVAILABILITY

» Steel

Dash Size	Male O-Ring Face Seal	Male O-Ring Face Seal
06-06	11/16-16	11/16-16
08-08	13/16-16	13/16-16
10-10	1-14	1-14
12-12	1 3/16-12	1 3/16-12
16-16	1 7/16-12	1 7/16-12

LS-FF2406

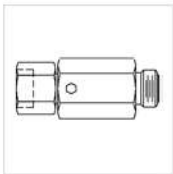

O-Ring Face Seal to O-Ring Face Seal

Other sizes and configurations are available upon request.

SHAPE

Straight

AVAILABILITY

» Steel

COMPLIANCE

» SAE 520123

Dash Size	Female O-Ring Face Seal Swivel	Male O-Ring Face Seal
06-06	11/16-16	11/16-16
08-08	13/16-16	13/16-16
12-12	1 3/16-12	1 3/16-12
16-16	1 7/16-12	1 7/16-12
24-24	2-12	2-12

LS-FF6400

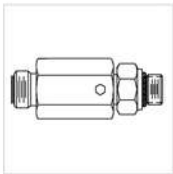

O-Ring Face Seal to O-Ring

Other sizes and configurations are available upon request.

SHAPE

Straight

AVAILABILITY

» Steel

Dash Size	Male O-Ring Face Seal	Male O-Ring
04-04	9/16-18	7/16-20
04-06	9/16-18	9/16-18
06-04	11/16-16	7/16-20
06-06	11/16-16	9/16-18
08-08	13/16-16	3/4-16

O-Ring Face Seal to O-Ring 90°

Other sizes and configurations are available upon request.

SHAPE

90 degree elbow

Dash Size	Male O-Ring Face Seal	Male O-Ring
04-06	9/16-18	9/16-18
06-06	11/16-16	9/16-18
08-08	13/16-16	3/4-16
08-10	13/16-16	7/8-14
08-12	13/16-16	1 1/16-12
10-08	1-14	3/4-16
10-10	1-14	7/8-14
12-08	1 3/16-12	3/4-16
12-12	1 3/16-12	1 1/16-12
16-16	1 7/16-12	1 5/16-12
20-20	1 11/16-12	1 5/8-12

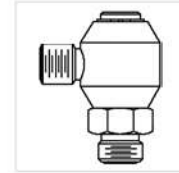

LS-FF6801

AVAILABILITY

» Steel

JIC to Pipe Elbow 90° - Dual Plane Swivel

Other sizes and configurations are available upon request.

SHAPE

90 degree elbow

Dash Size	Male JIC	Male Pipe
06-04	9/16-18	1/4-18
08-06	3/4-16	3/8-18
10-08	7/8-14	1/2-14
12-12	1 1/16-12	3/4-14
16-16	1 5/16-12	1-11 1/2
20-20	1 5/8-12	1 1/4-11 1/2
24-24	1 7/8-12	1 1/2-11 1/2



LSS-2501

AVAILABILITY

» Steel

JIC to O-Ring Elbow 90° - Dual Plane Swivel

Other sizes and configurations are available upon request.

SHAPE

90 degree elbow

Dash Size	Male JIC	Male O-Ring
06-06	9/16-18	9/16-18
08-08	3/4-16	3/4-16
10-10	7/8-14	7/8-14
12-12	1 1/16-12	1 1/16-12
16-16	1 5/16-12	1 5/16-12

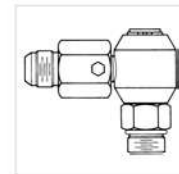

LSS-6801

AVAILABILITY

» Steel



BRASS ADAPTERS & FITTINGS

Brass Pipe Adapters

3120

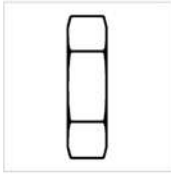

Pipe Lock Nut

SHAPE

Nut

Dash Size	Female Pipe
02	1/8-27
04	1/4-18
06	3/8-18
08	1/2-14
12	3/4-14

AVAILABILITY

» Brass

3129

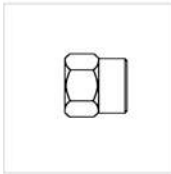

Pipe Cap

SHAPE

Cap

Dash Size	Female Pipe
02	1/8-27
04	1/4-18
06	3/8-18
08	1/2-14
12	3/4-14

AVAILABILITY

» Brass

3149



Hollow Hex Plug

SHAPE

Plug

Dash Size	Male Pipe
01	1/16-27
02	1/8-27
04	1/4-18
06	3/8-18
08	1/2-14
12	3/4-14

AVAILABILITY

» Brass

3150

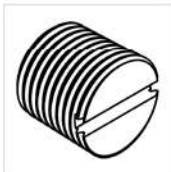

Slotted Plug

SHAPE

Plug

Dash Size	Male Pipe
02	1/8-27
04	1/4-18
06	3/8-18

AVAILABILITY

» Brass

Square Head Plug

SHAPE

Plug

Dash Size	Male Pipe
02	1/8-27
04	1/4-18
06	3/8-18
08	1/2-14
12	3/4-14
16	1-11 1/2
20	1 1/4-11 1/2
24	1 1/2-11 1/2

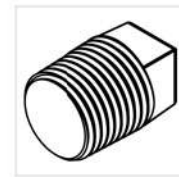

3151

AVAILABILITY

» Brass

Hex Head Plug

SHAPE

Plug

Dash Size	Male Pipe
01	1/16-27
02	1/8-27
04	1/4-18
06	3/8-18
08	1/2-14
12	3/4-14
16	1-11 1/2



3152

AVAILABILITY

» Brass

Pipe Expander/Extender

SHAPE

Expander

Dash Size	Male Pipe	Female Pipe
02-02	1/8-27	1/8-27
02-04	1/8-27	1/4-18
02-06	1/8-27	3/8-18
04-04	1/4-18	1/4-18
04-06	1/4-18	3/8-18
04-08	1/4-18	1/2-14
06-06	3/8-18	3/8-18
06-08	3/8-18	1/2-14
08-06	1/2-14	3/8-18
08-08	1/2-14	1/2-14
08-12	1/2-14	3/4-14
12-12	3/4-14	3/4-14

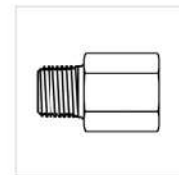

3200

AVAILABILITY

» Brass

3220



Hex Reducer Bushing

SHAPE

Reducer

Dash Size	Male Pipe	Female Pipe
04-02	1/4-18	1/8-27
06-02	3/8-18	1/8-27
06-04	3/8-18	1/4-18
08-02	1/2-14	1/8-27
08-04	1/2-14	1/4-18
08-06	1/2-14	3/8-18
12-02	3/4-14	1/8-27
12-04	3/4-14	1/4-18
12-06	3/4-14	3/8-18
12-08	3/4-14	1/2-14
16-04	1-11 1/2	1/4-18
16-06	1-11 1/2	3/8-18
16-08	1-11 1/2	1/2-14
16-12	1-11 1/2	3/4-14
20-08	1 1/4-11 1/2	1/2-14
20-12	1 1/4-11 1/2	3/4-14
20-16	1 1/4-11 1/2	1-11 1/2
24-04	1 1/2-11 1/2	1/4-18
24-12	1 1/2-11 1/2	3/4-14
24-16	1 1/2-11 1/2	1-11 1/2
32-12	2-11 1/2	3/4-14
32-16	2-11 1/2	1-11 1/2
32-20	2-11 1/2	1 1/4-11 1/2
32-24	2-11 1/2	1 1/2-11 1/2
40-24	2 1/2-8	1 1/2-11 1/2
40-32	2 1/2-8	2-11 1/2

AVAILABILITY

» Brass

3250

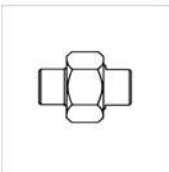

Pipe Swivel Union

SHAPE

Straight

Dash Size	Female Pipe	Female Pipe Swivel
02-02	1/8-27	1/8-27
04-04	1/4-18	1/4-18
06-06	3/8-18	3/8-18
08-08	1/2-14	1/2-14
12-12	3/4-14	3/4-14
16-16	1-11 1/2	1-11 1/2
20-20	1 1/4-11 1/2	1 1/4-11 1/2
24-24	1 1/2-11 1/2	1 1/2-11 1/2

AVAILABILITY

» Brass

Pipe Coupling

SHAPE

Straight

Dash Size	Female Pipe	Female Pipe
02-02	1/8-27	1/8-27
04-02	1/4-18	1/8-27
04-04	1/4-18	1/4-18
06-02	3/8-18	1/8-27
06-04	3/8-18	1/4-18
06-06	3/8-18	3/8-18
08-04	1/2-14	1/4-18
08-06	1/2-14	3/8-18
08-08	1/2-14	1/2-14
12-06	3/4-14	3/8-18
12-08	3/4-14	1/2-14
12-12	3/4-14	3/4-14
16-16	1-11 1/2	1-11 1/2

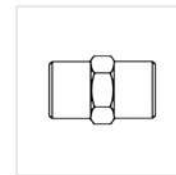

3300

AVAILABILITY

» Brass

Pipe Bulkhead Coupling

SHAPE

Straight

Dash Size	Female Pipe	Female Pipe	Overall Adapter Length (OAL)
02-02	1/8-27	1/8-27	1.50
04-04	1/4-18	1/4-18	0.94
04-04	1/4-18	1/4-18	1.50
06-06	3/8-18	3/8-18	1.31
08-08	1/2-14	1/2-14	1.50
12-12	3/4-14	3/4-14	1.50

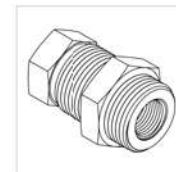

3300-BH

AVAILABILITY

» Brass

Hex Nipple

SHAPE

Straight

Dash Size	Male Pipe	Male Pipe
02-02	1/8-27	1/8-27
04-02	1/4-18	1/8-27
04-04	1/4-18	1/4-18
06-02	3/8-18	1/8-27
06-04	3/8-18	1/4-18
06-06	3/8-18	3/8-18
08-04	1/2-14	1/4-18
08-06	1/2-14	3/8-18
08-08	1/2-14	1/2-14
12-06	3/4-14	3/8-18
12-08	3/4-14	1/2-14
12-12	3/4-14	3/4-14
16-08	1-11 1/2	1/2-14
16-12	1-11 1/2	3/4-14
16-16	1-11 1/2	1-11 1/2
20-20	1 1/4-11 1/2	1 1/4-11 1/2
32-24	2-11 1/2	1 1/2-11 1/2

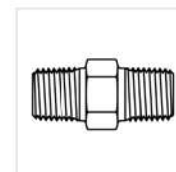

3325

AVAILABILITY

» Brass

3326



Close Nipple

SHAPE

Straight

AVAILABILITY

» Brass

Dash Size	Male Pipe	Male Pipe
02-02	1/8-27	1/8-27
04-04	1/4-18	1/4-18
06-06	3/8-18	3/8-18
08-08	1/2-14	1/2-14
12-12	3/4-14	3/4-14
16-16	1-11 1/2	1-11 1/2
20-20	1 1/4-11 1/2	1 1/4-11 1/2
24-24	1 1/2-11 1/2	1 1/2-11 1/2
32-32	2-11 1/2	2-11 1/2

3327



Long Nipple

SHAPE

Straight

AVAILABILITY

» Brass

Dash Size	Male Pipe	Male Pipe	Overall Adapter Length (OAL)
02-02	1/8-27	1/8-27	1.50
02-02	1/8-27	1/8-27	2.00
02-02	1/8-27	1/8-27	2.50
02-02	1/8-27	1/8-27	3.00
02-02	1/8-27	1/8-27	3.50
02-02	1/8-27	1/8-27	4.00
02-02	1/8-27	1/8-27	6.00
02-02	1/8-27	1/8-27	8.00
04-04	1/4-18	1/4-18	1.50
04-04	1/4-18	1/4-18	2.00
04-04	1/4-18	1/4-18	2.50
04-04	1/4-18	1/4-18	3.00
04-04	1/4-18	1/4-18	3.50
04-04	1/4-18	1/4-18	4.00
04-04	1/4-18	1/4-18	6.00
04-04	1/4-18	1/4-18	8.00
04-04	1/4-18	1/4-18	10.00
06-06	3/8-18	3/8-18	1.50
06-06	3/8-18	3/8-18	2.00
06-06	3/8-18	3/8-18	2.50
06-06	3/8-18	3/8-18	3.00
06-06	3/8-18	3/8-18	4.00
06-06	3/8-18	3/8-18	6.00
08-08	1/2-14	1/2-14	1.50
08-08	1/2-14	1/2-14	2.00
08-08	1/2-14	1/2-14	2.50
08-08	1/2-14	1/2-14	3.00
08-08	1/2-14	1/2-14	3.50
08-08	1/2-14	1/2-14	4.00
08-08	1/2-14	1/2-14	4.50
08-08	1/2-14	1/2-14	5.50
08-08	1/2-14	1/2-14	6.00
08-08	1/2-14	1/2-14	7.00
12-12	3/4-14	3/4-14	2.00
12-12	3/4-14	3/4-14	2.50
12-12	3/4-14	3/4-14	3.00

Dash Size	Male Pipe	Male Pipe	Overall Adapter Length (OAL)
12-12	3/4-14	3/4-14	3.50
12-12	3/4-14	3/4-14	6.00
12-12	3/4-14	3/4-14	8.00
12-12	3/4-14	3/4-14	10.00
16-16	1-11 1/2	1-11 1/2	18.00

3327
▼ continued

Street Elbow 45°

SHAPE

45 degree elbow

Dash Size	Male Pipe	Female Pipe
02-02	1/8-27	1/8-27
04-04	1/4-18	1/4-18
06-06	3/8-18	3/8-18
08-08	1/2-14	1/2-14
12-12	3/4-14	3/4-14
16-16	1-11 1/2	1-11 1/2



3350

AVAILABILITY
» Brass

Pipe Elbow 90°

SHAPE

90 degree elbow

Dash Size	Male Pipe	Male Pipe
02-02	1/8-27	1/8-27
04-02	1/4-18	1/8-27
04-04	1/4-18	1/4-18
06-04	3/8-18	1/4-18
06-06	3/8-18	3/8-18
08-08	1/2-14	1/2-14



3390

AVAILABILITY
» Brass

Street Elbow 90°

SHAPE

90 degree elbow

Dash Size	Male Pipe	Female Pipe
02-02	1/8-27	1/8-27
02-04	1/8-27	1/4-18
04-02	1/4-18	1/8-27
04-04	1/4-18	1/4-18
04-06	1/4-18	3/8-18
06-04	3/8-18	1/4-18
06-06	3/8-18	3/8-18
08-06	1/2-14	3/8-18
08-08	1/2-14	1/2-14
12-12	3/4-14	3/4-14



3400

AVAILABILITY
» Brass

3500

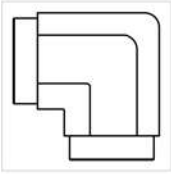

Pipe Elbow 90°

SHAPE

90 degree elbow

Dash Size	Female Pipe	Female Pipe
02-02	1/8-27	1/8-27
04-02	1/4-18	1/8-27
04-04	1/4-18	1/4-18
06-04	3/8-18	1/4-18
06-06	3/8-18	3/8-18
08-08	1/2-14	1/2-14
12-12	3/4-14	3/4-14
16-16	1-11 1/2	1-11 1/2

AVAILABILITY

» Brass

3600



Pipe Branch Tee

SHAPE

Tee

Dash Size	Female Pipe	Female Pipe	Male Pipe
02-02-02	1/8-27	1/8-27	1/8-27
04-04-04	1/4-18	1/4-18	1/4-18
06-06-06	3/8-18	3/8-18	3/8-18
08-08-08	1/2-14	1/2-14	1/2-14
12-12-12	3/4-14	3/4-14	3/4-14

AVAILABILITY

» Brass

3750

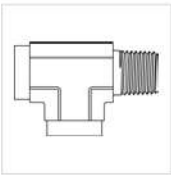

Street Tee

SHAPE

Tee

Dash Size	Female Pipe	Male Pipe	Female Pipe
02-02-02	1/8-27	1/8-27	1/8-27
04-04-04	1/4-18	1/4-18	1/4-18
06-06-06	3/8-18	3/8-18	3/8-18
08-08-08	1/2-14	1/2-14	1/2-14
12-12-12	3/4-14	3/4-14	3/4-14

AVAILABILITY

» Brass

3900

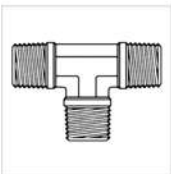

Pipe Tee

SHAPE

Tee

Dash Size	Male Pipe	Male Pipe	Male Pipe
02-02-02	1/8-27	1/8-27	1/8-27
04-04-04	1/4-18	1/4-18	1/4-18
06-06-06	3/8-18	3/8-18	3/8-18
08-08-08	1/2-14	1/2-14	1/2-14
12-12-12	3/4-14	3/4-14	3/4-14

AVAILABILITY

» Brass

Pipe Cross

SHAPE

Cross

Dash Size	Female Pipe	Female Pipe	Female Pipe	Female Pipe
02-02-02-02	1/8-27	1/8-27	1/8-27	1/8-27
04-04-04-04	1/4-18	1/4-18	1/4-18	1/4-18
06-06-06-06	3/8-18	3/8-18	3/8-18	3/8-18
08-08-08-08	1/2-14	1/2-14	1/2-14	1/2-14
12-12-12-12	3/4-14	3/4-14	3/4-14	3/4-14
20-20-20-20	1 1/4-11 1/2	1 1/4-11 1/2	1 1/4-11 1/2	1 1/4-11 1/2

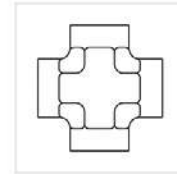

AVAILABILITY

» Brass

Breather Vent Plug

SHAPE

Plug

Dash Size	Male Pipe
02	1/8-27
04	1/4-18
06	3/8-18
08	1/2-14



AVAILABILITY

» Brass

Brass SAE 45° Adapters

40C



SAE 45° Cap

SHAPE

Cap

Dash Size	SAE 45 degree Female
03	3/8-24
04	7/16-20
05	1/2-20
06	5/8-18
08	3/4-16
10	7/8-14
12	1 1/16-14

AVAILABILITY

» Brass

40P

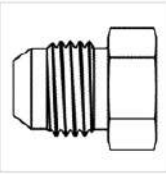

SAE 45° Plug

SHAPE

Plug

Dash Size	SAE 45 degree Male
03	3/8-24
04	7/16-20
05	1/2-20
06	5/8-18
08	3/4-16
10	7/8-14
12	1 1/16-14

AVAILABILITY

» Brass

41



SAE 45° Long Nut

SHAPE

Nut

Dash Size	SAE 45 degree Female
02	5/16-24
03	3/8-24
04	7/16-20
05	1/2-20
06	5/8-18
08	3/4-16
10	7/8-14
12	1 1/16-14

AVAILABILITY

» Brass

SAE 45° Short Nut

SHAPE

Nut

Dash Size	SAE 45 degree Female
02	5/16-24
03	3/8-24
04	7/16-20
05	1/2-20
06	5/8-18
08	3/4-16
10	7/8-14
12	1 1/16-14

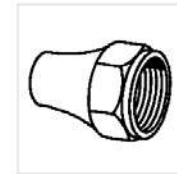

41S

AVAILABILITY

» Brass

SAE 45° Tube Union

SHAPE

Straight

Dash Size	SAE 45 degree Male	SAE 45 degree Male
02-02	5/16-24	5/16-24
03-03	3/8-24	3/8-24
04-04	7/16-20	7/16-20
05-04	1/2-20	7/16-20
05-05	1/2-20	1/2-20
06-04	5/8-18	7/16-20
06-05	5/8-18	1/2-20
06-06	5/8-18	5/8-18
08-06	3/4-16	5/8-18
08-08	3/4-16	3/4-16
10-06	7/8-14	5/8-18
10-08	7/8-14	3/4-16
10-10	7/8-14	7/8-14
12-08	1 1/16-14	3/4-16
12-12	1 1/16-14	1 1/16-14



42

AVAILABILITY

» Brass

SAE 45° Tube Union Tee

SHAPE

Tee

Dash Size	SAE 45 degree Male	SAE 45 degree Male	SAE 45 degree Male
02-02-02	5/16-24	5/16-24	5/16-24
03-03-03	3/8-24	3/8-24	3/8-24
04-04-04	7/16-20	7/16-20	7/16-20
04-04-06	7/16-20	7/16-20	5/8-18
05-05-05	1/2-20	1/2-20	1/2-20
06-06-04	5/8-18	5/8-18	7/16-20
06-06-06	5/8-18	5/8-18	5/8-18
06-06-08	5/8-18	5/8-18	3/4-16
08-08-06	3/4-16	3/4-16	5/8-18
08-08-08	3/4-16	3/4-16	3/4-16
10-10-06	7/8-14	7/8-14	5/8-18
10-10-08	7/8-14	7/8-14	3/4-16
10-10-10	7/8-14	7/8-14	7/8-14
12-12-12	1 1/16-14	1 1/16-14	1 1/16-14



44

AVAILABILITY

» Brass

45



SAE 45° Tube to Pipe Branch Tee

SHAPE

Tee

Dash Size	SAE 45 degree Male	SAE 45 degree Male	Male Pipe
02-02-02	5/16-24	5/16-24	1/8-27
03-03-02	3/8-24	3/8-24	1/8-27
04-04-02	7/16-20	7/16-20	1/8-27
04-04-04	7/16-20	7/16-20	1/4-18
04-04-06	7/16-20	7/16-20	3/8-18
05-05-02	1/2-20	1/2-20	1/8-27
05-05-04	1/2-20	1/2-20	1/4-18
06-06-02	5/8-18	5/8-18	1/8-27
06-06-04	5/8-18	5/8-18	1/4-18
06-06-06	5/8-18	5/8-18	3/8-18
06-06-08	5/8-18	5/8-18	1/2-14
08-08-04	3/4-16	3/4-16	1/4-18
08-08-06	3/4-16	3/4-16	3/8-18
08-08-08	3/4-16	3/4-16	1/2-14
10-10-06	7/8-14	7/8-14	3/8-18
10-10-08	7/8-14	7/8-14	1/2-14
12-12-08	1 1/16-14	1 1/16-14	1/2-14
12-12-12	1 1/16-14	1 1/16-14	3/4-14

AVAILABILITY

» Brass

46



SAE 45° Tube to Pipe

SHAPE

Straight

Dash Size	SAE 45 degree Male	Female Pipe
02-02	5/16-24	1/8-27
03-02	3/8-24	1/8-27
03-04	3/8-24	1/4-18
04-02	7/16-20	1/8-27
04-04	7/16-20	1/4-18
04-06	7/16-20	3/8-18
04-08	7/16-20	1/2-14
05-02	1/2-20	1/8-27
05-04	1/2-20	1/4-18
06-02	5/8-18	1/8-27
06-04	5/8-18	1/4-18
06-06	5/8-18	3/8-18
06-08	5/8-18	1/2-14
06-12	5/8-18	3/4-14
08-04	3/4-16	1/4-18
08-06	3/4-16	3/8-18
08-08	3/4-16	1/2-14
08-12	3/4-16	3/4-14
10-06	7/8-14	3/8-18
10-08	7/8-14	1/2-14
10-12	7/8-14	3/4-14
12-08	1 1/16-14	1/2-14
12-12	1 1/16-14	3/4-14

AVAILABILITY

» Brass

SAE 45° Tube to Pipe

SHAPE

Straight



48

Dash Size	SAE 45 degree Male	Male Pipe
02-02	5/16-24	1/8-27
03-02	3/8-24	1/8-27
03-04	3/8-24	1/4-18
04-02	7/16-20	1/8-27
04-04	7/16-20	1/4-18
04-06	7/16-20	3/8-18
04-08	7/16-20	1/2-14
05-02	1/2-20	1/8-27
05-04	1/2-20	1/4-18
05-06	1/2-20	3/8-18
05-08	1/2-20	1/2-14
06-02	5/8-18	1/8-27
06-04	5/8-18	1/4-18
06-06	5/8-18	3/8-18
06-08	5/8-18	1/2-14
06-12	5/8-18	3/4-14
08-04	3/4-16	1/4-18
08-06	3/4-16	3/8-18
08-08	3/4-16	1/2-14
08-12	3/4-16	3/4-14
10-04	7/8-14	1/4-18
10-06	7/8-14	3/8-18
10-08	7/8-14	1/2-14
10-12	7/8-14	3/4-14
12-08	1 1/16-14	1/2-14
12-12	1 1/16-14	3/4-14
14-12	1 1/4-12	3/4-14
16-12	1 3/8-12	3/4-14
16-16	1 3/8-12	1-11 1/2

AVAILABILITY

» Brass

SAE 45° Tube to Pipe Elbow 90°

SHAPE

90 degree elbow



49

Dash Size	SAE 45 degree Male	Male Pipe
02-02	5/16-24	1/8-27
03-02	3/8-24	1/8-27
03-04	3/8-24	1/4-18
04-02	7/16-20	1/8-27
04-04	7/16-20	1/4-18
04-06	7/16-20	3/8-18
04-08	7/16-20	1/2-14
05-02	1/2-20	1/8-27
05-04	1/2-20	1/4-18
05-06	1/2-20	3/8-18
05-08	1/2-20	1/2-14
06-02	5/8-18	1/8-27
06-04	5/8-18	1/4-18
06-06	5/8-18	3/8-18
06-08	5/8-18	1/2-14
06-12	5/8-18	3/4-14

AVAILABILITY

» Brass

▼ 49 continues

49
▼ continued

Dash Size	SAE 45 degree Male	Male Pipe
08-04	3/4-16	1/4-18
08-06	3/4-16	3/8-18
08-08	3/4-16	1/2-14
08-12	3/4-16	3/4-14
10-04	7/8-14	1/4-18
10-06	7/8-14	3/8-18
10-08	7/8-14	1/2-14
10-12	7/8-14	3/4-14
12-08	1 1/16-14	1/2-14
12-12	1 1/16-14	3/4-14
14-12	1 1/4-12	3/4-14

50

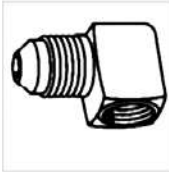

SAE 45° Tube to Pipe Elbow 90°

SHAPE

90 degree elbow

Dash Size	SAE 45 degree Male	Female Pipe
03-02	3/8-24	1/8-27
04-02	7/16-20	1/8-27
04-04	7/16-20	1/4-18
04-06	7/16-20	3/8-18
04-08	7/16-20	1/2-14
05-02	1/2-20	1/8-27
05-04	1/2-20	1/4-18
06-02	5/8-18	1/8-27
06-04	5/8-18	1/4-18
06-06	5/8-18	3/8-18
06-08	5/8-18	1/2-14
06-12	5/8-18	3/4-14
08-04	3/4-16	1/4-18
08-06	3/4-16	3/8-18
08-08	3/4-16	1/2-14
08-12	3/4-16	3/4-14
10-06	7/8-14	3/8-18
10-08	7/8-14	1/2-14
10-12	7/8-14	3/4-14
12-08	1 1/16-14	1/2-14
12-12	1 1/16-14	3/4-14
14-12	1 1/4-12	3/4-14

AVAILABILITY
» Brass

51



SAE 45° Tube to Pipe Run Tee

SHAPE

Tee

Dash Size	SAE 45 degree Male	Male Pipe	SAE 45 degree Male
03-02-03	3/8-24	1/8-27	3/8-24
04-02-04	7/16-20	1/8-27	7/16-20
04-04-04	7/16-20	1/4-18	7/16-20
05-02-05	1/2-20	1/8-27	1/2-20
05-04-05	1/2-20	1/4-18	1/2-20
06-02-06	5/8-18	1/8-27	5/8-18
06-04-06	5/8-18	1/4-18	5/8-18
06-06-06	5/8-18	3/8-18	5/8-18
06-08-06	5/8-18	1/2-14	5/8-18

AVAILABILITY
» Brass

Dash Size	SAE 45 degree Male	Male Pipe	SAE 45 degree Male
08-04-08	3/4-16	1/4-18	3/4-16
08-06-08	3/4-16	3/8-18	3/4-16
08-08-08	3/4-16	1/2-14	3/4-16
10-06-10	7/8-14	3/8-18	7/8-14
10-08-10	7/8-14	1/2-14	7/8-14
10-12-10	7/8-14	3/4-14	7/8-14
12-08-12	1 1/16-14	1/2-14	1 1/16-14
12-12-12	1 1/16-14	3/4-14	1 1/16-14

51
▼ continued

SAE 45° Tube Union Cross

SHAPE

Cross

Dash Size	SAE 45 degree Male	SAE 45 degree Male	SAE 45 degree Male	SAE 45 degree Male
04-04-04-04	7/16-20	7/16-20	7/16-20	7/16-20
05-05-05-05	1/2-20	1/2-20	1/2-20	1/2-20
06-06-06-06	5/8-18	5/8-18	5/8-18	5/8-18
08-08-08-08	3/4-16	3/4-16	3/4-16	3/4-16
10-10-10-10	7/8-14	7/8-14	7/8-14	7/8-14

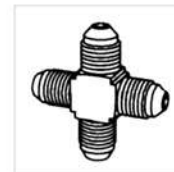

52

AVAILABILITY

» Brass

SAE 45° Tube to Pipe Elbow 45°

SHAPE

45 degree elbow

Dash Size	SAE 45 degree Male	Male Pipe
04-02	7/16-20	1/8-27
04-04	7/16-20	1/4-18
05-02	1/2-20	1/8-27
05-04	1/2-20	1/4-18
06-04	5/8-18	1/4-18
06-06	5/8-18	3/8-18
06-08	5/8-18	1/2-14
08-06	3/4-16	3/8-18
08-08	3/4-16	1/2-14
10-08	7/8-14	1/2-14
12-08	1 1/16-14	1/2-14
12-12	1 1/16-14	3/4-14



54

AVAILABILITY

» Brass

55



SAE 45° Tube Union Elbow 90°

SHAPE

90 degree elbow

Dash Size	SAE 45 degree Male	SAE 45 degree Male
02-02	5/16-24	5/16-24
03-03	3/8-24	3/8-24
04-04	7/16-20	7/16-20
05-05	1/2-20	1/2-20
06-04	5/8-18	7/16-20
06-06	5/8-18	5/8-18
08-06	3/4-16	5/8-18
08-08	3/4-16	3/4-16
10-08	7/8-14	3/4-16
10-10	7/8-14	7/8-14
12-08	1 1/16-14	3/4-16
12-12	1 1/16-14	1 1/16-14
14-14	1 1/4-12	1 1/4-12

AVAILABILITY

» Brass

5700

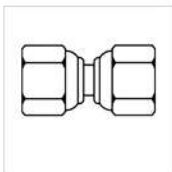

SAE 45° Swivel Union

SHAPE

Straight

Dash Size	SAE 45 degree Female Swivel	SAE 45 degree Female Swivel
04-04	7/16-20	7/16-20
05-05	1/2-20	1/2-20
06-06	5/8-18	5/8-18
08-08	3/4-16	3/4-16
10-08	7/8-14	3/4-16
10-10	7/8-14	7/8-14
12-12	1 1/16-14	1 1/16-14

AVAILABILITY

» Brass

5790

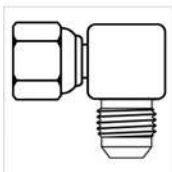

SAE 45° Swivel to Elbow 90°

SHAPE

90 degree elbow

Dash Size	SAE 45 degree Female Swivel	SAE 45 degree Male
04-04	7/16-20	7/16-20
06-06	5/8-18	5/8-18
08-08	3/4-16	3/4-16
10-10	7/8-14	7/8-14
12-12	1 1/16-14	1 1/16-14

AVAILABILITY

» Brass

Brass Hose Barb Fittings

Hose Barb Tee

SHAPE

Tee

Dash Size	Hose Barb	Hose Barb	Hose Barb
04-04-04	1/4	1/4	1/4
05-05-05	5/16	5/16	5/16
06-06-06	3/8	3/8	3/8
08-08-08	1/2	1/2	1/2

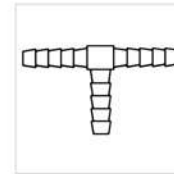

29T

AVAILABILITY

» Brass

Hose Splicer

SHAPE

Straight

Dash Size	Hose Barb	Hose Barb
02-02	1/8	1/8
03-03	3/16	3/16
04-04	1/4	1/4
05-05	5/16	5/16
06-04	3/8	1/4
06-06	3/8	3/8
08-08	1/2	1/2
10-06	5/8	3/8
10-10	5/8	5/8
12-12	3/4	3/4
16-16	1	1

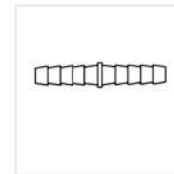

4200

AVAILABILITY

» Brass

Hose Barb to Pipe

Also available in stainless steel upon request.

SHAPE

Straight

Dash Size	Hose Barb	Male Pipe
02-01	1/8	1/16-27
02-02	1/8	1/8-27
02-04	1/8	1/4-18
03-02	3/16	1/8-27
03-04	3/16	1/4-18
04-02	1/4	1/8-27
04-04	1/4	1/4-18
04-06	1/4	3/8-18
04-08	1/4	1/2-14
05-02	5/16	1/8-27
05-04	5/16	1/4-18
05-06	5/16	3/8-18
05-08	5/16	1/2-14
06-02	3/8	1/8-27
06-04	3/8	1/4-18
06-06	3/8	3/8-18
06-08	3/8	1/2-14
06-12	3/8	3/4-14

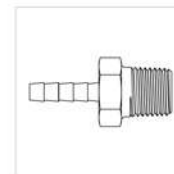

4244

AVAILABILITY

» Brass

▼ 4244 continues

4244
▼ continued

Dash Size	Hose Barb	Male Pipe
08-04	1/2	1/4-18
08-06	1/2	3/8-18
08-08	1/2	1/2-14
08-12	1/2	3/4-14
10-06	5/8	3/8-18
10-08	5/8	1/2-14
10-12	5/8	3/4-14
12-06	3/4	3/8-18
12-08	3/4	1/2-14
12-12	3/4	3/4-14
12-16	3/4	1-11 1/2
16-08	1	1/2-14
16-12	1	3/4-14
16-16	1	1-11 1/2
20-16	1 1/4	1-11 1/2

4245

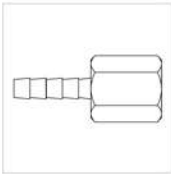

Hose Barb to Pipe (RIGID)

SHAPE

Straight

Dash Size	Hose Barb	Female Pipe
02-02	1/8	1/8-27
02-04	1/8	1/4-18
03-02	3/16	1/8-27
03-04	3/16	1/4-18
04-02	1/4	1/8-27
04-04	1/4	1/4-18
04-06	1/4	3/8-18
05-02	5/16	1/8-27
05-04	5/16	1/4-18
05-06	5/16	3/8-18
06-02	3/8	1/8-27
06-04	3/8	1/4-18
06-06	3/8	3/8-18
06-08	3/8	1/2-14
08-04	1/2	1/4-18
08-06	1/2	3/8-18
08-08	1/2	1/2-14
12-12	3/4	3/4-14
16-12	1	3/4-14
16-16	1	1-11 1/2

AVAILABILITY

» Brass

Hose Barb to Ball Seat Pipe Swivel

SHAPE

Straight

Dash Size	Hose Barb	Female Pipe Swivel
02-02	1/8	1/8-27
03-02	3/16	1/8-27
03-04	3/16	1/4-18
04-04	1/4	1/4-18
04-06	1/4	3/8-18
05-04	5/16	1/4-18
06-04	3/8	1/4-18
06-06	3/8	3/8-18
06-08	3/8	1/2-14
08-06	1/2	3/8-18
08-08	1/2	1/2-14
12-12	3/4	3/4-14

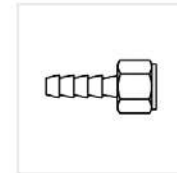

4245-S

AVAILABILITY

» Brass

Hose Barb to SAE 45° Flare

SHAPE

Straight

Dash Size	Hose Barb	SAE 45 degree Flare
04-04	1/4	7/16-20
04-06	1/4	5/8-18
05-05	5/16	1/2-20
06-06	3/8	5/8-18
08-08	1/2	3/4-16

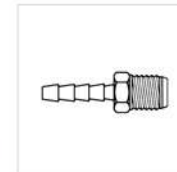

4250

AVAILABILITY

» Brass

Hose Barb to JIC Swivel

SHAPE

Straight

Dash Size	Hose Barb	Female JIC Swivel
03-03	3/16	3/8-24
04-04	1/4	7/16-20
04-05	1/4	1/2-20
04-06	1/4	9/16-18
05-06	5/16	9/16-18
06-06	3/8	9/16-18
06-08	3/8	3/4-16
08-08	1/2	3/4-16
08-10	1/2	7/8-14
10-10	5/8	7/8-14
12-12	3/4	1 1/16-12

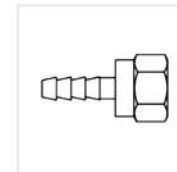

4255

AVAILABILITY

» Brass

4290

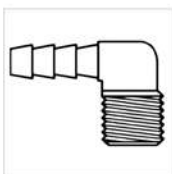

Hose Barb to Pipe Elbow 90°

Also available in stainless steel upon request.

SHAPE

90 degree elbow

Dash Size	Hose Barb	Male Pipe
02-04	1/8	1/4-18
03-04	3/16	1/4-18
04-02	1/4	1/8-27
04-04	1/4	1/4-18
04-06	1/4	3/8-18
05-02	5/16	1/8-27
05-04	5/16	1/4-18
05-06	5/16	3/8-18
06-02	3/8	1/8-27
06-04	3/8	1/4-18
06-06	3/8	3/8-18
06-08	3/8	1/2-14
08-04	1/2	1/4-18
08-06	1/2	3/8-18
08-08	1/2	1/2-14
10-06	5/8	3/8-18
10-08	5/8	1/2-14
10-12	5/8	3/4-14
12-08	3/4	1/2-14
12-12	3/4	3/4-14
16-12	1	3/4-14
16-16	1	1-11 1/2

AVAILABILITY

» Brass

4295

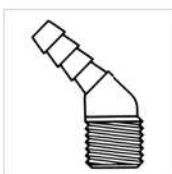

Hose Barb to Pipe Elbow 45°

SHAPE

45 degree elbow

Dash Size	Hose Barb	Male Pipe
04-02	1/4	1/8-27
04-04	1/4	1/4-18
05-04	5/16	1/4-18
06-02	3/8	1/8-27
06-04	3/8	1/4-18
06-06	3/8	3/8-18
08-06	1/2	3/8-18
10-06	5/8	3/8-18

AVAILABILITY

» Brass

Brass Ferrule

SHAPE

Ferrule

SKU	Ferrule ID	Ferrule Nominal Size
BFL-0375	0.375	375
BFL-0425	0.425	425
BFL-0450	0.45	450
BFL-0475	0.475	475
BFL-0500	0.5	500
BFL-0525	0.525	525
BFL-0550	0.55	550
BFL-0575	0.575	575
BFL-0600	0.6	600
BFL-0625	0.625	625
BFL-0650	0.65	650
BFL-0675	0.675	675
BFL-0700	0.7	700
BFL-0725	0.725	725
BFL-0750	0.75	750
BFL-0775	0.775	775
BFL-0800	0.8	800
BFL-0825	0.825	825
BFL-0850	0.85	850
BFL-0875	0.875	875
BFL-0900	0.9	900
BFL-0925	0.925	925
BFL-0950	0.95	950
BFL-0975	0.975	975
BFL-1000	1	1000
BFL-1025	1.025	1025
BFL-1075	1.075	1075
BFL-1100	1.1	1100
BFL-1225	1.225	1225
BFL-1350	1.35	1350
BFL-1400	1.4	1,400
BFL-1500	1.5	1,500

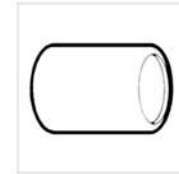

AVAILABILITY

» Brass

Hose Barb to Pipe Swivel

SHAPE

Straight

Dash Size	Hose Barb	Male Pipe Swivel
04-04	1/4	1/4-18
06-04	3/8	1/4-18
06-06	3/8	3/8-18
08-06	1/2	3/8-18
08-08	1/2	1/2-14
12-12	3/4	3/4-14

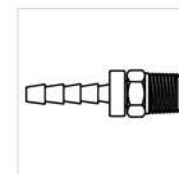

AVAILABILITY

» Brass

Brass Push-On Barb Fittings

4300

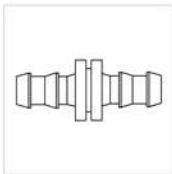

Hose Splicer

SHAPE Straight

Dash Size	Hose Barb	Hose Barb
04-04	1/4	1/4
05-05	5/16	5/16
06-06	3/8	3/8
08-08	1/2	1/2
10-10	5/8	5/8
12-12	3/4	3/4

AVAILABILITY

» Brass

4301

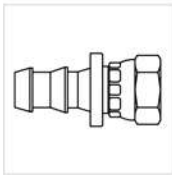

Push-on Barb to SAE 45° Swivel

SHAPE Straight

Dash Size	Hose Barb	SAE 45 degree Female Swivel
04-04	1/4	7/16-20
04-05	1/4	1/2-20
04-06	1/4	5/8-18
05-06	5/16	5/8-18
06-05	3/8	1/2-20
06-06	3/8	5/8-18
06-08	3/8	3/4-16
08-06	1/2	5/8-18
08-08	1/2	3/4-16
08-10	1/2	7/8-14
10-08	5/8	3/4-16
10-10	5/8	7/8-14
10-12	5/8	1 1/16-14
12-12	3/4	1 1/16-14

AVAILABILITY

» Brass

4303

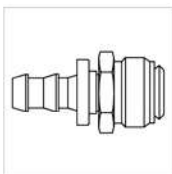

Push-on Barb to SAE 45° Inverted Flare

SHAPE Straight

Dash Size	Hose Barb	Inverted Flare
04-03	1/4	3/8-24
04-04	1/4	7/16-24
04-05	1/4	1/2-20
05-04	5/16	7/16-24
05-05	5/16	1/2-20
05-06	5/16	5/8-18
06-05	3/8	1/2-20
06-06	3/8	5/8-18
06-08	3/8	3/4-18
08-08	1/2	3/4-18
10-10	5/8	7/8-18
12-12	3/4	1 1/16-16

AVAILABILITY

» Brass

Push-on Barb to SAE 45° Inverted Flare

SHAPE

Straight

Dash Size	Hose Barb	Inverted Flare
04-03	1/4	3/8-24
04-04	1/4	7/16-24
04-05	1/4	1/2-20
06-05	3/8	1/2-20
06-06	3/8	5/8-18
08-08	1/2	3/4-18

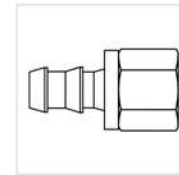

4305

AVAILABILITY

» Brass

Push-on Barb to JIC Swivel DUAL SEAT 37/45 DEG

Also available in stainless steel upon request.

SHAPE

Straight

Dash Size	Hose Barb	Female JIC Swivel
04-04	1/4	7/16-20
04-05	1/4	1/2-20
04-06	1/4	9/16-18
05-05	5/16	1/2-20
06-05	3/8	1/2-20
06-06	3/8	9/16-18
06-08	3/8	3/4-16
08-08	1/2	3/4-16
08-10	1/2	7/8-14
10-08	5/8	3/4-16
10-10	5/8	7/8-14
12-10	3/4	7/8-14
12-12	3/4	1 1/16-12
16-16	1	1 5/16-12

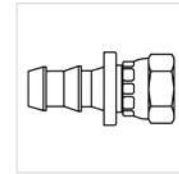

4311

AVAILABILITY

» Brass

Push-on Barb to Pipe

Also available in stainless steel upon request.

SHAPE

Straight

Dash Size	Hose Barb	Male Pipe
04-02	1/4	1/8-27
04-04	1/4	1/4-18
04-06	1/4	3/8-18
05-02	5/16	1/8-27
05-04	5/16	1/4-18
06-02	3/8	1/8-27
06-04	3/8	1/4-18
06-06	3/8	3/8-18
06-08	3/8	1/2-14
08-04	1/2	1/4-18
08-06	1/2	3/8-18
08-08	1/2	1/2-14
08-12	1/2	3/4-14
10-06	5/8	3/8-18
10-08	5/8	1/2-14
10-12	5/8	3/4-14

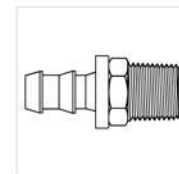

4312

AVAILABILITY

» Brass

▼ 4312 continues

4312

▼ continued

Dash Size	Hose Barb	Male Pipe
12-08	3/4	1/2-14
12-12	3/4	3/4-14
16-16	1	1-11 1/2

4313



Push-on Barb to JIC

SHAPE Straight

Dash Size	Hose Barb	Male JIC
04-04	1/4	7/16-20
04-05	1/4	1/2-20
04-06	1/4	9/16-18
06-06	3/8	9/16-18
06-08	3/8	3/4-16
08-08	1/2	3/4-16

AVAILABILITY

» Brass

4315

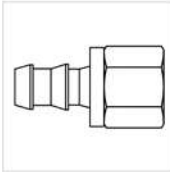

Push-on Barb to Pipe

SHAPE Straight

Dash Size	Hose Barb	Female Pipe
04-02	1/4	1/8-27
04-04	1/4	1/4-18
05-04	5/16	1/4-18
06-04	3/8	1/4-18
06-06	3/8	3/8-18
08-06	1/2	3/8-18
08-08	1/2	1/2-14

AVAILABILITY

» Brass

4320

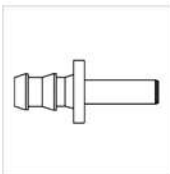

Push-on Barb to Standpipe

SHAPE Straight

Dash Size	Hose Barb	Metric Standpipe
04-03	1/4	3mm
04-04	1/4	4mm
05-05	5/16	5mm
06-06	3/8	6mm

AVAILABILITY

» Brass

4330

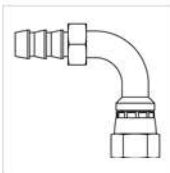

Steel Push-on Barb to JIC Swivel 90° Bent Tube

SHAPE 90 degree elbow

Dash Size	Hose Barb	Female JIC Swivel
04-04	1/4	7/16-20
06-06	3/8	9/16-18
08-08	1/2	3/4-16
10-10	5/8	7/8-14

AVAILABILITY

» Steel

Push-on Barb to Pipe Elbow 90°

SHAPE

90 degree elbow

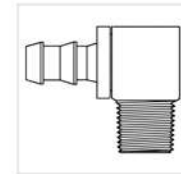

4390

AVAILABILITY

» Brass

Dash Size	Hose Barb	Male Pipe
04-02	1/4	1/8-27
04-04	1/4	1/4-18
06-02	3/8	1/8-27
06-04	3/8	1/4-18
06-06	3/8	3/8-18
06-08	3/8	1/2-14
08-06	1/2	3/8-18
08-08	1/2	1/2-14
10-08	5/8	1/2-14
10-12	5/8	3/4-14
12-12	3/4	3/4-14

Push-On Barb to Pipe Swivel - Brass

SHAPE

Straight

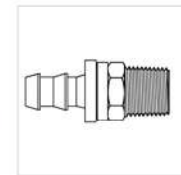

LS-4312

AVAILABILITY

» Brass

Dash Size	Hose Barb	Male Pipe Swivel
04-04	1/4	1/4-18
06-04	3/8	1/4-18
06-06	3/8	3/8-18
08-06	1/2	3/8-18
08-08	1/2	1/2-14
12-12	3/4	3/4-14

Brass Compression Adapters

60

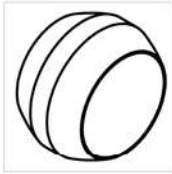

Tube Sleeve

SHAPE

Sleeve

Dash Size	Tube Size
02	1/8
03	3/16
04	1/4
05	5/16
06	3/8
08	1 1/2
10	5/8
12	3/4
14	7/8

AVAILABILITY

» Brass

60P



Delrin Tube Sleeve (NYLON)

SHAPE

Sleeve

Dash Size	Tube Size
04	1/4
05	5/16
06	3/8
08	1/2
10	5/8
12	3/4

AVAILABILITY

» Nylon

61

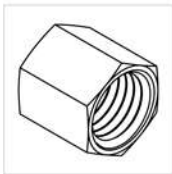

Tube Nut

SHAPE

Nut

Dash Size	Brass Compression
02	5/16-24
03	3/8-24
04	7/16-24
05	1/2-24
06	9/16-24
08	1 1/16-20
10	1 3/16-18
12	1-18
14	1 1/8-18

AVAILABILITY

» Brass

Tube Cap

SHAPE

Cap

Dash Size	Brass Compression
03	3/8-24
04	7/16-24
06	9/16-24
08	11/16-20
10	13/16-18

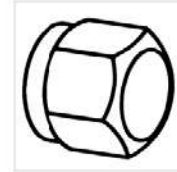

61C

AVAILABILITY

» Brass

Long Tube Nut

SHAPE

Nut

Dash Size	Brass Compression
03	3/8-24
04	7/16-24
05	1/2-24
06	9/16-24
08	11/16-20
10	13/16-18
12	1-18

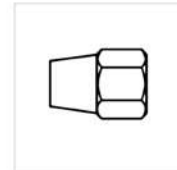

61L

AVAILABILITY

» Brass

Tube Union

SHAPE

Straight

Dash Size	Brass Compression	Brass Compression
02-02	5/16-24	5/16-24
03-03	3/8-24	3/8-24
04-02	7/16-24	5/16-24
04-04	7/16-24	7/16-24
05-05	1/2-24	1/2-24
06-04	9/16-24	7/16-24
06-06	9/16-24	9/16-24
08-06	11/16-20	9/16-24
08-08	11/16-20	11/16-20
10-08	13/16-18	11/16-20
10-10	13/16-18	13/16-18
12-12	1-18	1-18
14-14	1 1/8-18	1 1/8-18

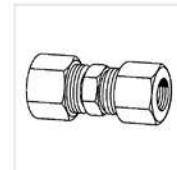

62

AVAILABILITY

» Brass

Bulkhead Tube Union

SHAPE

Straight

Dash Size	Brass Compression	Brass Compression
04-04	7/16-24	7/16-24
05-05	1/2-24	1/2-24
06-06	9/16-24	9/16-24
08-08	11/16-20	11/16-20



62-BH

AVAILABILITY

» Brass

64



Tube Union Tee

SHAPE Tee

Dash Size	Brass Compression	Brass Compression	Brass Compression
02-02-02	5/16-24	5/16-24	5/16-24
03-03-03	3/8-24	3/8-24	3/8-24
04-04-04	7/16-24	7/16-24	7/16-24
05-05-05	1/2-24	1/2-24	1/2-24
06-06-04	9/16-24	9/16-24	7/16-24
06-06-06	9/16-24	9/16-24	9/16-24
08-08-06	11/16-20	11/16-20	9/16-24
08-08-08	11/16-20	11/16-20	11/16-20
10-10-10	13/16-18	13/16-18	13/16-18
12-12-12	1-18	1-18	1-18

AVAILABILITY

» Brass

65



Tube Union Elbow 90°

SHAPE 90 degree elbow

Dash Size	Brass Compression	Brass Compression
02-02	5/16-24	5/16-24
03-03	3/8-24	3/8-24
04-04	7/16-24	7/16-24
05-05	1/2-24	1/2-24
06-04	9/16-24	7/16-24
06-06	9/16-24	9/16-24
08-06	11/16-20	9/16-24
08-08	11/16-20	11/16-20
10-08	13/16-18	11/16-20
10-10	13/16-18	13/16-18
12-12	1-18	1-18
14-14	1 1/8-18	1 1/8-18

AVAILABILITY

» Brass

66



Tube to Pipe

SHAPE Straight

Dash Size	Brass Compression	Female Pipe
02-02	5/16-24	1/8-27
03-02	3/8-24	1/8-27
04-02	7/16-24	1/8-27
04-04	7/16-24	1/4-18
04-06	7/16-24	3/8-18
04-08	7/16-24	1/2-14
05-02	1/2-24	1/8-27
05-04	1/2-24	1/4-18
06-02	9/16-24	1/8-27
06-04	9/16-24	1/4-18
06-06	9/16-24	3/8-18
06-08	9/16-24	1/2-14
06-12	9/16-24	3/4-14
08-04	11/16-20	1/4-18
08-06	11/16-20	3/8-18
08-08	11/16-20	1/2-14
08-12	11/16-20	3/4-14
10-06	13/16-18	3/8-18

AVAILABILITY

» Brass

Dash Size	Brass Compression	Female Pipe
10-08	13/16-18	1/2-14
10-12	13/16-18	3/4-14
12-08	1-18	1/2-14
12-12	1-18	3/4-14

66
▼ continued

Tube to Pipe Elbow 45°

SHAPE

45 degree elbow

Dash Size	Brass Compression	Male Pipe
03-02	3/8-24	1/8-27
04-02	7/16-24	1/8-27
04-04	7/16-24	1/4-18
05-02	1/2-24	1/8-27
05-04	1/2-24	1/4-18
06-04	9/16-24	1/4-18
06-06	9/16-24	3/8-18
06-08	9/16-24	1/2-14
08-06	11/16-20	3/8-18
08-08	11/16-20	1/2-14
10-08	13/16-18	1/2-14



67

AVAILABILITY
» Brass

Tube to Pipe

SHAPE

Straight

Dash Size	Brass Compression	Male Pipe
02-01	5/16-24	1/16-27
02-02	5/16-24	1/8-27
03-01	3/8-24	1/16-27
03-02	3/8-24	1/8-27
03-04	3/8-24	1/4-18
04-02	7/16-24	1/8-27
04-04	7/16-24	1/4-18
04-06	7/16-24	3/8-18
04-08	7/16-24	1/2-14
05-02	1/2-24	1/8-27
05-04	1/2-24	1/4-18
05-06	1/2-24	3/8-18
05-08	1/2-24	1/2-14
06-02	9/16-24	1/8-27
06-04	9/16-24	1/4-18
06-06	9/16-24	3/8-18
06-08	9/16-24	1/2-14
06-12	9/16-24	3/4-14
08-04	11/16-20	1/4-18
08-06	11/16-20	3/8-18
08-08	11/16-20	1/2-14
08-12	11/16-20	3/4-14
10-06	13/16-18	3/8-18
10-08	13/16-18	1/2-14
10-12	13/16-18	3/4-14
12-08	1-18	1/2-14
12-12	1-18	3/4-14
14-12	1 1/8-18	3/4-14



68

AVAILABILITY
» Brass

69



Tube to Pipe Elbow 90°

SHAPE

90 degree elbow

Dash Size	Brass Compression	Male Pipe
02-02	5/16-24	1/8-27
03-02	3/8-24	1/8-27
03-04	3/8-24	1/4-18
04-02	7/16-24	1/8-27
04-04	7/16-24	1/4-18
04-06	7/16-24	3/8-18
04-08	7/16-24	1/2-14
05-02	1/2-24	1/8-27
05-04	1/2-24	1/4-18
05-06	1/2-24	3/8-18
06-02	9/16-24	1/8-27
06-04	9/16-24	1/4-18
06-06	9/16-24	3/8-18
06-08	9/16-24	1/2-14
06-12	9/16-24	3/4-14
08-04	11/16-20	1/4-18
08-06	11/16-20	3/8-18
08-08	11/16-20	1/2-14
08-12	11/16-20	3/4-14
10-06	13/16-18	3/8-18
10-08	13/16-18	1/2-14
10-12	13/16-18	3/4-14
12-08	1-18	1/2-14
12-12	1-18	3/4-14
14-12	1 1/8-18	3/4-14

AVAILABILITY

» Brass

70

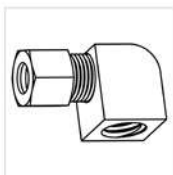

Tube to Pipe Elbow 90°

SHAPE

90 degree elbow

Dash Size	Brass Compression	Female Pipe
02-02	5/16-24	1/8-27
03-02	3/8-24	1/8-27
04-02	7/16-24	1/8-27
04-04	7/16-24	1/4-18
04-06	7/16-24	3/8-18
04-08	7/16-24	1/2-14
05-02	1/2-24	1/8-27
06-02	9/16-24	1/8-27
06-04	9/16-24	1/4-18
06-06	9/16-24	3/8-18
08-04	11/16-20	1/4-18
08-06	11/16-20	3/8-18
08-08	11/16-20	1/2-14
10-06	13/16-18	3/8-18
10-08	13/16-18	1/2-14
10-12	13/16-18	3/4-14
12-08	1-18	1/2-14
12-12	1-18	3/4-14

AVAILABILITY

» Brass

Tube to Pipe Run Tee

SHAPE

Tee



71

Dash Size	Brass Compression	Male Pipe	Brass Compression
02-02-02	5/16-24	1/8-27	5/16-24
03-02-03	3/8-24	1/8-27	3/8-24
04-02-04	7/16-24	1/8-27	7/16-24
04-04-04	7/16-24	1/4-18	7/16-24
05-02-05	1/2-24	1/8-27	1/2-24
05-04-05	1/2-24	1/4-18	1/2-24
06-02-06	9/16-24	1/8-27	9/16-24
06-04-06	9/16-24	1/4-18	9/16-24
06-06-06	9/16-24	3/8-18	9/16-24
08-06-08	11/16-20	3/8-18	11/16-20
08-08-08	11/16-20	1/2-14	11/16-20
10-08-10	13/16-18	1/2-14	13/16-18
12-08-12	1-18	1/2-14	1-18
12-12-12	1-18	3/4-14	1-18

AVAILABILITY

» Brass

Tube to Pipe Branch Tee

SHAPE

Tee

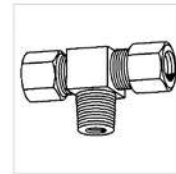

72

Dash Size	Brass Compression	Brass Compression	Male Pipe
02-02-02	5/16-24	5/16-24	1/8-27
03-03-02	3/8-24	3/8-24	1/8-27
04-04-02	7/16-24	7/16-24	1/8-27
04-04-04	7/16-24	7/16-24	1/4-18
05-05-02	1/2-24	1/2-24	1/8-27
06-06-02	9/16-24	9/16-24	1/8-27
06-06-04	9/16-24	9/16-24	1/4-18
06-06-06	9/16-24	9/16-24	3/8-18
08-08-04	11/16-20	11/16-20	1/4-18
08-08-06	11/16-20	11/16-20	3/8-18
08-08-08	11/16-20	11/16-20	1/2-14
10-10-08	13/16-18	13/16-18	1/2-14
12-12-08	1-18	1-18	1/2-14
12-12-12	1-18	1-18	3/4-14

AVAILABILITY

» Brass

Tube Insert

SHAPE

Insert

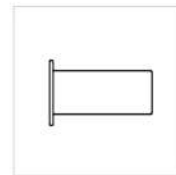

73

Dash Size	Brass Compression
02	5/16-24
03	3/8-24
04	7/16-24
05	1/2-24
06	9/16-24
08	11/16-20
10	13/16-18
12	1-18

AVAILABILITY

» Brass

Brass Inverted Flare Adapters

100



Inverted Flare Nut-Brass

SHAPE

Nut

Dash Size	Inverted Flare
02	5/16-28
03	3/8-24
04	7/16-24
05	1/2-20
06	5/8-18
08	3/4-18

AVAILABILITY

» Brass

105



Inverted Flare Nut-Steel

SHAPE

Nut

Dash Size	Inverted Flare
02	5/16-28
03	3/8-24
04	7/16-24
05	1/2-20
06	5/8-18
08	3/4-18
10	7/8-18
12	1 1/16-16

AVAILABILITY

» Steel

131



Inverted Flare Plug

SHAPE

Plug

Dash Size	Inverted Flare
03	3/8-24
04	7/16-24
05	1/2-20
06	5/8-18
08	3/4-18

AVAILABILITY

» Brass

Tube to Pipe

SHAPE

Straight

Dash Size	Inverted Flare	Male Pipe
02-02	5/16-28	1/8-27
03-02	3/8-24	1/8-27
04-02	7/16-24	1/8-27
04-04	7/16-24	1/4-18
05-02	1/2-20	1/8-27
05-04	1/2-20	1/4-18
06-02	5/8-18	1/8-27
06-04	5/8-18	1/4-18
06-06	5/8-18	3/8-18
08-04	3/4-18	1/4-18
08-06	3/4-18	3/8-18
08-08	3/4-18	1/2-14
10-08	7/8-18	1/2-14
12-12	1 1/16-16	3/4-14

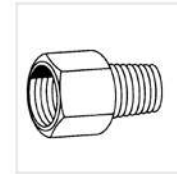

202

AVAILABILITY

» Brass

Tube to Pipe

SHAPE

Straight

Dash Size	Inverted Flare	Female Pipe
03-02	3/8-24	1/8-27
04-02	7/16-24	1/8-27
04-04	7/16-24	1/4-18
05-02	1/2-20	1/8-27
06-04	5/8-18	1/4-18
08-06	3/4-18	3/8-18
10-08	7/8-18	1/2-14
10-12	7/8-18	3/4-14

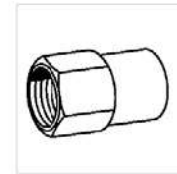

252

AVAILABILITY

» Brass

Tube Union

SHAPE

Straight

Dash Size	Inverted Flare	Inverted Flare
02-02	5/16-28	5/16-28
03-03	3/8-24	3/8-24
04-04	7/16-24	7/16-24
05-05	1/2-20	1/2-20
06-06	5/8-18	5/8-18
08-08	3/4-18	3/4-18

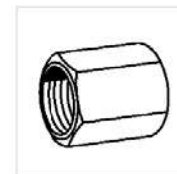

302

AVAILABILITY

» Brass

352

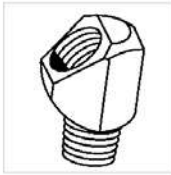

Tube to Pipe Elbow 45°

SHAPE

45 degree elbow

Dash Size	Inverted Flare	Male Pipe
03-02	3/8-24	1/8-27
04-02	7/16-24	1/8-27
05-02	1/2-20	1/8-27
05-04	1/2-20	1/4-18
06-04	5/8-18	1/4-18
08-06	3/4-18	3/8-18

AVAILABILITY

» Brass

402



Tube to Pipe Elbow 90°

SHAPE

90 degree elbow

Dash Size	Inverted Flare	Male Pipe
02-02	5/16-28	1/8-27
03-02	3/8-24	1/8-27
04-02	7/16-24	1/8-27
04-04	7/16-24	1/4-18
05-02	1/2-20	1/8-27
05-04	1/2-20	1/4-18
06-02	5/8-18	1/8-27
06-04	5/8-18	1/4-18
06-06	5/8-18	3/8-18
08-06	3/4-18	3/8-18
08-08	3/4-18	1/2-14
10-08	7/8-18	1/2-14
12-12	1 1/16-16	3/4-14

AVAILABILITY

» Brass

452

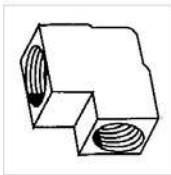

Tube to Pipe Elbow 90°

SHAPE

90 degree elbow

Dash Size	Inverted Flare	Female Pipe
04-02	7/16-24	1/8-27
05-02	1/2-20	1/8-27
06-04	5/8-18	1/4-18
08-06	3/4-18	3/8-18
10-08	7/8-18	1/2-14

AVAILABILITY

» Brass

502

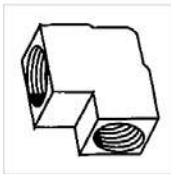

Tube Union Elbow 90°

SHAPE

90 degree elbow

Dash Size	Inverted Flare	Inverted Flare
04-04	7/16-24	7/16-24
05-05	1/2-20	1/2-20
06-06	5/8-18	5/8-18
08-08	3/4-18	3/4-18

AVAILABILITY

» Brass

Tube to Pipe Branch Tee

SHAPE

Tee

Dash Size	Inverted Flare	Inverted Flare	Male Pipe
03-03-02	3/8-24	3/8-24	1/8-27
04-04-02	7/16-24	7/16-24	1/8-27
05-05-02	1/2-20	1/2-20	1/8-27
06-06-04	5/8-18	5/8-18	1/4-18
08-08-06	3/4-18	3/4-18	3/8-18

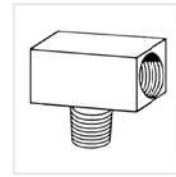

602

AVAILABILITY

» Brass

Tube Union Tee

SHAPE

Tee

Dash Size	Inverted Flare	Inverted Flare	Inverted Flare
03-03-03	3/8-24	3/8-24	3/8-24
04-04-04	7/16-24	7/16-24	7/16-24
05-05-05	1/2-20	1/2-20	1/2-20
06-06-06	5/8-18	5/8-18	5/8-18
08-08-08	3/4-18	3/4-18	3/4-18

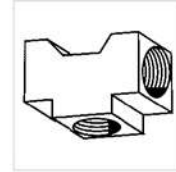

702

AVAILABILITY

» Brass

Tube to Pipe Run Tee

SHAPE

Tee

Dash Size	Inverted Flare	Male Pipe	Inverted Flare
03-02-03	3/8-24	1/8-27	3/8-24
04-02-04	7/16-24	1/8-27	7/16-24
05-02-05	1/2-20	1/8-27	1/2-20
06-04-06	5/8-18	1/4-18	5/8-18
08-06-08	3/4-18	3/8-18	3/4-18

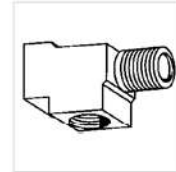

752

AVAILABILITY

» Brass

Brass Needle Valves and Drain Cocks

DC602



Internal Seat

Dash Size	Male Pipe
02	1/8-27
04	1/4-18
06	3/8-18

AVAILABILITY

» Brass

DC603



Tee Handle Internal Seat

Dash Size	Male Pipe
02	1/8-27
04	1/4-18
06	3/8-18
08	1/2-14

AVAILABILITY

» Brass

DC604



External Seat

Dash Size	Male Pipe
02	1/8-27
04	1/4-18
06	3/8-18
08	1/2-14

AVAILABILITY

» Brass

DC606



External Seat

Dash Size	Male Pipe
04	1/4-18

AVAILABILITY

» Brass

DC607



Angle BIB Drain Cock

SHAPE 90 degree elbow

Dash Size	Male Pipe
02	1/8-27
04	1/4-18

AVAILABILITY

» Brass

SAE 45° to Pipe Elbow 90°

SHAPE

90 degree elbow

Dash Size	SAE 45 degree Flare	Male Pipe
04-02	7/16-20	1/8-27
05-02	1/2-20	1/8-27
05-04	1/2-20	1/4-18
06-04	5/8-18	1/4-18



NV101

AVAILABILITY

» Brass

SAE 45° Union

SHAPE

Straight

Dash Size	SAE 45 degree Flare	SAE 45 degree Flare
04-04	7/16-20	7/16-20
06-06	5/8-18	5/8-18



NV102

AVAILABILITY

» Brass

SAE 45° to Pipe

SHAPE

Straight

Dash Size	SAE 45 degree Flare	Male Pipe
04-02	7/16-20	1/8-27
04-04	7/16-20	1/4-18
05-02	1/2-20	1/8-27
06-04	5/8-18	1/4-18



NV103

AVAILABILITY

» Brass

Compression to Pipe Elbow 90°

SHAPE

90 degree elbow

Dash Size	Brass Compression	Male Pipe
03-02	3/8-24	1/8-27
04-02	7/16-24	1/8-27
04-04	7/16-24	1/4-18
06-04	9/16-24	1/4-18



NV104

AVAILABILITY

» Brass

Compression Union

SHAPE

Straight

Dash Size	Brass Compression	Brass Compression
03-03	3/8-24	3/8-24
04-04	7/16-24	7/16-24
05-05	1/2-24	1/2-24
06-06	9/16-24	9/16-24



NV105

AVAILABILITY

» Brass

NV106



Compression to Pipe

SHAPE Straight

Dash Size	Brass Compression	Male Pipe
03-02	3/8-24	1/8-27
04-02	7/16-24	1/8-27
04-04	7/16-24	1/4-18
05-02	1/2-24	1/8-27
06-04	9/16-24	1/4-18

AVAILABILITY

» Brass

NV107



Pipe Union

SHAPE Straight

Dash Size	Male Pipe	Male Pipe
02-02	1/8-27	1/8-27
04-04	1/4-18	1/4-18

AVAILABILITY

» Brass

NV108



Pipe to Pipe

SHAPE Straight

Dash Size	Male Pipe	Female Pipe
02-02	1/8-27	1/8-27
04-04	1/4-18	1/4-18

AVAILABILITY

» Brass

NV109



Pipe Union

SHAPE Straight

Dash Size	Female Pipe	Female Pipe
02-02	1/8-27	1/8-27
04-04	1/4-18	1/4-18

AVAILABILITY

» Brass

Brass Poly Flow Fittings

Nylon Sleeve

SHAPE Sleeve

Dash Size	Tube Size
04	1/4
05	5/16
06	3/8
08	1/2



AVAILABILITY
» Nylon

Brass Sleeve

SHAPE Sleeve

Dash Size	Tube Size
02	1/8
04	1/4
05	5/16
06	3/8
08	1/2



AVAILABILITY
» Brass

Brass Nut and Nylon Sleeve Assembly

SHAPE Nut

Dash Size	Poly Flow
04	1/4
05	5/16
06	3/8
08	1/2

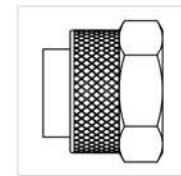

AVAILABILITY
» Nylon

Brass Nut and Brass Sleeve

SHAPE Nut

Dash Size	Poly Flow
02	1/8
04	1/4
06	3/8
08	1/2

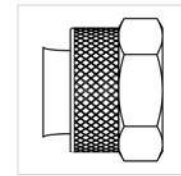

AVAILABILITY
» Brass

261U

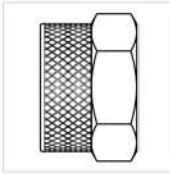

Brass Nut

SHAPE

Nut

Dash Size	Poly Flow
02	1/8
03	3/16
04	1/4
05	5/16
06	3/8
08	1/2

AVAILABILITY

» Brass

262P



Tube Union

SHAPE

Straight

Dash Size	Poly Flow	Poly Flow
02-02	1/8	1/8
03-03	3/16	3/16
04-04	1/4	1/4
05-05	5/16	5/16
06-06	3/8	3/8
08-08	1/2	1/2

AVAILABILITY

» Brass

264P

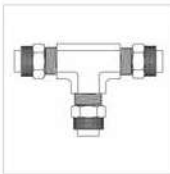

Tube Union Tee

SHAPE

Tee

Dash Size	Poly Flow	Poly Flow	Poly Flow
02-02-02	1/8	1/8	1/8
03-03-03	3/16	3/16	3/16
04-04-04	1/4	1/4	1/4
05-05-05	5/16	5/16	5/16
06-06-06	3/8	3/8	3/8
08-08-08	1/2	1/2	1/2

AVAILABILITY

» Brass

266P

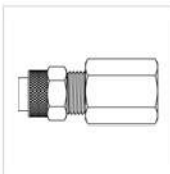

Tube to Pipe

SHAPE

Straight

Dash Size	Poly Flow	Female Pipe
02-02	1/8	1/8-27
04-02	1/4	1/8-27
04-04	1/4	1/4-18
05-02	5/16	1/8-27
06-04	3/8	1/4-18
08-06	1/2	3/8-18

AVAILABILITY

» Brass

Tube to Pipe

SHAPE

Straight

Dash Size	Poly Flow	Male Pipe
02-01	1/8	1/16-27
02-02	1/8	1/8-27
02-10/32	1/8	10-32 UNF
03-02	3/16	1/8-27
04-01	1/4	1/16-27
04-02	1/4	1/8-27
04-04	1/4	1/4-18
04-06	1/4	3/8-18
04-10/32	1/4	10-32 UNF
05-02	5/16	1/8-27
05-04	5/16	1/4-18
06-02	3/8	1/8-27
06-04	3/8	1/4-18
06-06	3/8	3/8-18
08-06	1/2	3/8-18
08-08	1/2	1/2-14



268P

AVAILABILITY

» Brass

Tube to Pipe Elbow 90°

SHAPE

90 degree elbow

Dash Size	Poly Flow	Male Pipe
02-02	1/8	1/8-27
03-02	3/16	1/8-27
04-01	1/4	1/16-27
04-02	1/4	1/8-27
04-04	1/4	1/4-18
04-06	1/4	3/8-18
05-02	5/16	1/8-27
06-02	3/8	1/8-27
06-04	3/8	1/4-18
06-06	3/8	3/8-18
08-06	1/2	3/8-18

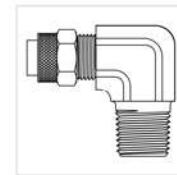

269P

AVAILABILITY

» Brass

Tube to Pipe Elbow 90°

SHAPE

90 degree elbow

Dash Size	Poly Flow	Female Pipe
04-02	1/4	1/8-27
04-04	1/4	1/4-18
05-02	5/16	1/8-27
06-04	3/8	1/4-18
08-06	1/2	3/8-18

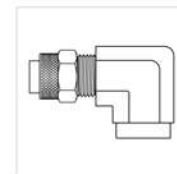

270P

AVAILABILITY

» Brass

271P



Tube to Pipe Run Tee

SHAPE

Tee

Dash Size	Poly Flow	Male Pipe	Poly Flow
02-02-02	1/8	1/8-27	1/8
04-02-04	1/4	1/8-27	1/4
04-04-04	1/4	1/4-18	1/4
05-02-05	5/16	1/8-27	5/16
06-02-06	3/8	1/8-27	3/8
06-04-06	3/8	1/4-18	3/8
08-06-08	1/2	3/8-18	1/2

AVAILABILITY

» Brass

272P

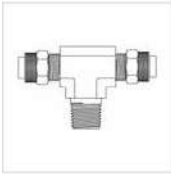

Tube to Pipe Branch Tee

SHAPE

Tee

Dash Size	Poly Flow	Poly Flow	Male Pipe
02-02-02	1/8	1/8	1/8-27
04-04-02	1/4	1/4	1/8-27
04-04-04	1/4	1/4	1/4-18
05-05-02	5/16	5/16	1/8-27
06-06-02	3/8	3/8	1/8-27
06-06-04	3/8	3/8	1/4-18
08-08-06	1/2	1/2	3/8-18

AVAILABILITY

» Brass

282P



Tube Bulkhead Union

SHAPE

Straight

Dash Size	Poly Flow	Poly Flow
04-04	1/4	1/4
05-05	5/16	5/16
06-06	3/8	3/8
08-08	1/2	1/2

AVAILABILITY

» Brass

Brass Poly Push Fittings

Tube Union

Also available with nickel plating. Order as NP262PP-XX-XX.

SHAPE

Straight

Dash Size	Poly Push	Poly Push
02-02	1/8	1/8
02.5-02.5	5/32	5/32
04-04	1/4	1/4
05-05	5/16	5/16
06-06	3/8	3/8
08-08	1/2	1/2

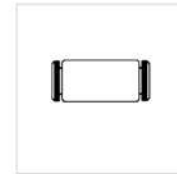

262PP

AVAILABILITY

» Brass

Tube Union Reducer

SHAPE

Reducer

Dash Size	Poly Push	Poly Push
04-02	1/4	1/8
05-02.5	5/16	5/32
05-04	5/16	1/4
06-02	3/8	1/8
06-02.5	3/8	5/32
06-04	3/8	1/4
06-05	3/8	5/16
08-04	1/2	1/4
08-06	1/2	3/8

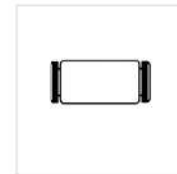

263PP

AVAILABILITY

» Brass

Tube Union Tee

Also available with nickel plating. Order as NP264PP-XX-XX.

SHAPE

Tee

Dash Size	Poly Push	Poly Push	Poly Push
02-02-02	1/8	1/8	1/8
02.5-02.5-02.5	5/32	5/32	5/32
04-04-04	1/4	1/4	1/4
05-05-05	5/16	5/16	5/16
06-06-06	3/8	3/8	3/8
08-08-08	1/2	1/2	1/2



264PP

AVAILABILITY

» Brass

Tube Union Elbow 90°

Also available with nickel plating. Order as NP265PP-XX-XX.

SHAPE

90 degree elbow

Dash Size	Poly Push	Poly Push
02.5-02.5	5/32	5/32
04-04	1/4	1/4
05-05	5/16	5/16
06-06	3/8	3/8
08-08	1/2	1/2

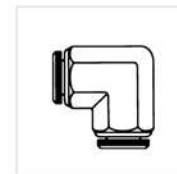

265PP

AVAILABILITY

» Brass

266PP



Tube to Pipe

Also available with nickel plating. Order as NP266PP-XX-XX.

SHAPE

Straight

Dash Size	Poly Push	Female Pipe
02-02	1/8	1/8-27
02.5-02	5/32	1/8-27
04-02	1/4	1/8-27
04-04	1/4	1/4-18
06-04	3/8	1/4-18
06-06	3/8	3/8-18

AVAILABILITY

» Brass

268PP



Tube to Pipe

Also available with nickel plating. Order as NP268PP-XX-XX.

SHAPE

Straight

Dash Size	Poly Push	Male Pipe
02-01	1/8	1/16-27
02-02	1/8	1/8-27
02-10/32	1/8	10-32 UNF
02.5-02	5/32	1/8-27
02.5-04	5/32	1/4-18
02.5-10/32	5/32	10-32 UNF
03-02	3/16	1/8-27
04-01	1/4	1/16-27
04-02	1/4	1/8-27
04-04	1/4	1/4-18
04-06	1/4	3/8-18
04-10/32	1/4	10-32 UNF
05-02	5/16	1/8-27
05-04	5/16	1/4-18
06-02	3/8	1/8-27
06-04	3/8	1/4-18
06-06	3/8	3/8-18
06-08	3/8	1/2-14
08-04	1/2	1/4-18
08-06	1/2	3/8-18
08-08	1/2	1/2-14

AVAILABILITY

» Brass

269PP

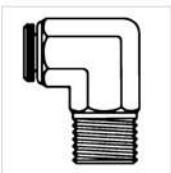

Tube to Pipe Elbow 90°

Also available with nickel plating. Order as NP269PP-XX-XX.

SHAPE

90 degree elbow

Dash Size	Poly Push	Male Pipe
02-02	1/8	1/8-27
02.5-02	5/32	1/8-27
03-02	3/16	1/8-27
04-02	1/4	1/8-27
04-04	1/4	1/4-18
04-06	1/4	3/8-18
05-02	5/16	1/8-27
05-04	5/16	1/4-18

AVAILABILITY

» Brass

Dash Size	Poly Push	Male Pipe
06-02	3/8	1/8-27
06-04	3/8	1/4-18
06-06	3/8	3/8-18
08-06	1/2	3/8-18
08-08	1/2	1/2-14

269PP
▼ continued

Tube to Pipe Elbow 90°

SHAPE

90 degree elbow

Dash Size	Poly Push	Female Pipe
02.5-02	5/32	1/8-27
04-02	1/4	1/8-27
04-04	1/4	1/4-18
06-04	3/8	1/4-18

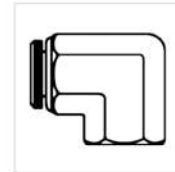

270PP

AVAILABILITY
» Brass

Tube to Pipe Swivel Run Tee

Also available with nickel plating. Order as NP271PP-XX-XX-XX.

SHAPE

Tee

Dash Size	Poly Push	Male Pipe Swivel	Poly Push
02.5-02-02.5	5/32	1/8-27	5/32
04-02-04	1/4	1/8-27	1/4
04-04-04	1/4	1/4-18	1/4
05-02-05	5/16	1/8-27	5/16
06-04-06	3/8	1/4-18	3/8
08-06-08	1/2	3/8-18	1/2
08-08-08	1/2	1/2-14	1/2



271PP

AVAILABILITY
» Brass

Tube to Pipe Swivel Branch Tee

Also available with nickel plating. Order as NP272PP-XX-XX-XX.

SHAPE

Tee

Dash Size	Poly Push	Poly Push	Male Pipe Swivel
02-02-02	1/8	1/8	1/8-27
02.5-02.5-02	5/32	5/32	1/8-27
04-04-02	1/4	1/4	1/8-27
04-04-04	1/4	1/4	1/4-18
05-05-02	5/16	5/16	1/8-27
06-06-04	3/8	3/8	1/4-18
06-06-06	3/8	3/8	3/8-18
08-08-06	1/2	1/2	3/8-18
08-08-08	1/2	1/2	1/2-14



272PP

AVAILABILITY
» Brass

279PP

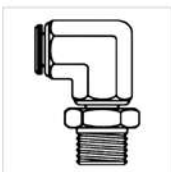

Tube to Pipe Swivel Elbow 90°

Also available with nickel plating. Order as NP279PP-XX-XX.

SHAPE

90 degree elbow

Dash Size	Poly Push	Male Pipe Swivel
02-02	1/8	1/8-27
02-04	1/8	1/4-18
02.5-02	5/32	1/8-27
02.5-04	5/32	1/4-18
04-02	1/4	1/8-27
04-04	1/4	1/4-18
05-02	5/16	1/8-27
05-04	5/16	1/4-18
06-02	3/8	1/8-27
06-04	3/8	1/4-18
06-06	3/8	3/8-18
06-08	3/8	1/2-14
08-04	1/2	1/4-18
08-06	1/2	3/8-18
08-08	1/2	1/2-14

AVAILABILITY

» Brass

282PP



Tube Bulkhead Union

Also available with nickel plating. Order as NP282PP-XX-XX.

SHAPE

Straight

Dash Size	Poly Push	Poly Push
02-02	1/8	1/8
02.5-02.5	5/32	5/32
04-04	1/4	1/4
05-05	5/16	5/16
06-06	3/8	3/8
08-08	1/2	1/2

AVAILABILITY

» Brass

284PP

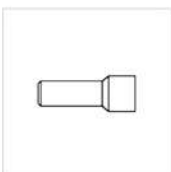

Tube Plug

SHAPE

Plug

Dash Size	Poly Push
02	1/8
02.5	5/32
04	1/4
05	5/16
06	3/8
08	1/2

AVAILABILITY

» Brass

Brass D.O.T. Air Brake Fittings

Tube Sleeve

SHAPE

Sleeve

Dash Size	Tube Size
04	1/4
06	3/8
08	1/2
10	5/8
12	3/4



1460

AVAILABILITY
» Brass

Tube Nut

SHAPE

Nut

Dash Size	Brass Compression
04	7/16-24
06	9/16-24
08	11/16-20
10	13/16-18
12	1-18



1461

AVAILABILITY
» Brass

Tube Union

SHAPE

Straight

Dash Size	Brass Compression	Brass Compression
04-04	7/16-24	7/16-24
06-06	9/16-24	9/16-24
08-06	11/16-20	9/16-24
08-08	11/16-20	11/16-20
10-10	13/16-18	13/16-18
12-12	1-18	1-18

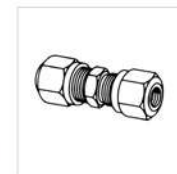

1462

AVAILABILITY
» Brass

Tube Union Tee

SHAPE

Tee

Dash Size	Brass Compression	Brass Compression	Brass Compression
04-04-04	7/16-24	7/16-24	7/16-24
06-06-06	9/16-24	9/16-24	9/16-24
08-08-06	11/16-20	11/16-20	9/16-24
08-08-08	11/16-20	11/16-20	11/16-20
10-10-10	13/16-18	13/16-18	13/16-18

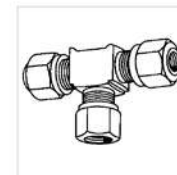

1464

AVAILABILITY
» Brass

1465



Tube Union Elbow 90°

SHAPE

90 degree elbow

Dash Size	Brass Compression	Brass Compression
04-04	7/16-24	7/16-24
06-06	9/16-24	9/16-24
08-08	11/16-20	11/16-20
10-10	13/16-18	13/16-18

AVAILABILITY

» Brass

1466

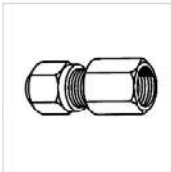

Tube to Pipe

SHAPE

Straight

Dash Size	Brass Compression	Female Pipe
04-02	7/16-24	1/8-27
04-04	7/16-24	1/4-18
06-02	9/16-24	1/8-27
06-04	9/16-24	1/4-18
06-06	9/16-24	3/8-18
08-06	11/16-20	3/8-18
08-08	11/16-20	1/2-14
10-06	13/16-18	3/8-18
10-08	13/16-18	1/2-14

AVAILABILITY

» Brass

1468



Tube to Pipe

SHAPE

Straight

Dash Size	Brass Compression	Male Pipe
04-02	7/16-24	1/8-27
04-04	7/16-24	1/4-18
04-06	7/16-24	3/8-18
06-02	9/16-24	1/8-27
06-04	9/16-24	1/4-18
06-06	9/16-24	3/8-18
06-08	9/16-24	1/2-14
08-04	11/16-20	1/4-18
08-06	11/16-20	3/8-18
08-08	11/16-20	1/2-14
10-06	13/16-18	3/8-18
10-08	13/16-18	1/2-14
10-12	13/16-18	3/4-14
12-08	1-18	1/2-14
12-12	1-18	3/4-14

AVAILABILITY

» Brass

Tube to Pipe Elbow 90°

SHAPE

90 degree elbow

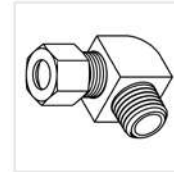

1469

Dash Size	Brass Compression	Male Pipe
04-02	7/16-24	1/8-27
04-04	7/16-24	1/4-18
04-06	7/16-24	3/8-18
06-02	9/16-24	1/8-27
06-04	9/16-24	1/4-18
06-06	9/16-24	3/8-18
06-08	9/16-24	1/2-14
08-04	11/16-20	1/4-18
08-06	11/16-20	3/8-18
08-08	11/16-20	1/2-14
10-06	13/16-18	3/8-18
10-08	13/16-18	1/2-14
10-12	13/16-18	3/4-14
12-08	1-18	1/2-14
12-12	1-18	3/4-14

AVAILABILITY

» Brass

Tube to Pipe Elbow 90°

SHAPE

90 degree elbow

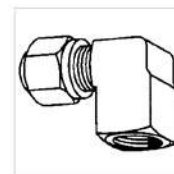

1470

Dash Size	Brass Compression	Female Pipe
04-02	7/16-24	1/8-27
04-04	7/16-24	1/4-18
06-02	9/16-24	1/8-27
06-04	9/16-24	1/4-18
06-06	9/16-24	3/8-18
08-06	11/16-20	3/8-18
08-08	11/16-20	1/2-14
10-08	13/16-18	1/2-14

AVAILABILITY

» Brass

Tube to Pipe Run Tee

SHAPE

Tee

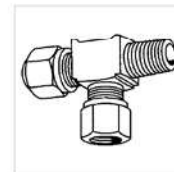

1471

Dash Size	Brass Compression	Male Pipe	Brass Compression
04-02-04	7/16-24	1/8-27	7/16-24
04-04-04	7/16-24	1/4-18	7/16-24
06-04-06	9/16-24	1/4-18	9/16-24
06-06-06	9/16-24	3/8-18	9/16-24
08-06-08	11/16-20	3/8-18	11/16-20
08-08-08	11/16-20	1/2-14	11/16-20
10-08-10	13/16-18	1/2-14	13/16-18

AVAILABILITY

» Brass

1472



Tube to Pipe Branch Tee

SHAPE Tee

Dash Size	Brass Compression	Brass Compression	Male Pipe
04-04-02	7/16-24	7/16-24	1/8-27
04-04-04	7/16-24	7/16-24	1/4-18
06-06-02	9/16-24	9/16-24	1/8-27
06-06-04	9/16-24	9/16-24	1/4-18
06-06-06	9/16-24	9/16-24	3/8-18
08-08-04	11/16-20	11/16-20	1/4-18
08-08-06	11/16-20	11/16-20	3/8-18
08-08-08	11/16-20	11/16-20	1/2-14
10-10-08	13/16-18	13/16-18	1/2-14

AVAILABILITY

» Brass

1473

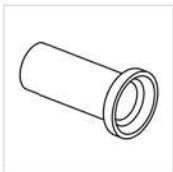

Tube Insert

SHAPE Insert

Dash Size	Comp DOT
04	1/4
06	3/8
08	1/2
10	5/8
12	3/4

AVAILABILITY

» Stainless Steel

1474

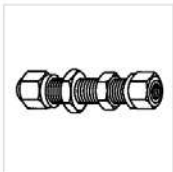

Tube Bulkhead Union

SHAPE Straight

Dash Size	Brass Compression	Brass Compression
04-04	7/16-24	7/16-24
06-06	9/16-24	9/16-24
08-08	11/16-20	11/16-20

AVAILABILITY

» Brass

1480



Tube to Pipe Elbow 45°

SHAPE 45 degree elbow

Dash Size	Brass Compression	Male Pipe
04-02	7/16-24	1/8-27
04-04	7/16-24	1/4-18
06-02	9/16-24	1/8-27
06-04	9/16-24	1/4-18
06-06	9/16-24	3/8-18
06-08	9/16-24	1/2-14
08-06	11/16-20	3/8-18
08-08	11/16-20	1/2-14
10-08	13/16-18	1/2-14
12-08	1-18	1/2-14

AVAILABILITY

» Brass

Air Brake Insert

SHAPE

Insert

Dash Size	Comp DOT
04	1/4
06	3/8
08	1/2
10	5/8

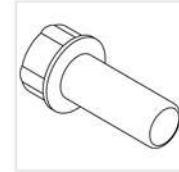
**1484**

AVAILABILITY

» Brass

Brass Push-In D.O.T. Fittings

1562

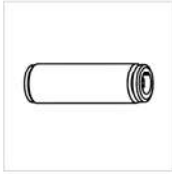

Tube Union

SHAPE Straight

Dash Size	Push-In DOT	Push-In DOT
02-02	1/8	1/8
02.5-02.5	5/32	5/32
03-03	3/16	3/16
04-04	1/4	1/4
06-06	3/8	3/8
08-08	1/2	1/2
10-10	5/8	5/8

AVAILABILITY

» Brass

1564



Tube Union Tee

SHAPE Tee

Dash Size	Push-In DOT	Push-In DOT	Push-In DOT
04-04-04	1/4	1/4	1/4
06-06-06	3/8	3/8	3/8
08-08-08	1/2	1/2	1/2
12-12-12	3/4	3/4	3/4

AVAILABILITY

» Brass

1565



Tube Union Elbow 90°

SHAPE 90 degree elbow

Dash Size	Push-In DOT	Push-In DOT
04-04	1/4	1/4
06-06	3/8	3/8
08-08	1/2	1/2

AVAILABILITY

» Brass

1566



Tube to Pipe

SHAPE Straight

Dash Size	Push-In DOT	Female Pipe
04-02	1/4	1/8-27
04-04	1/4	1/4-18
06-04	3/8	1/4-18
06-06	3/8	3/8-18
08-08	1/2	1/2-14

AVAILABILITY

» Brass

Tube to Pipe

SHAPE

Straight

Dash Size	Push-In DOT	Male Pipe
02.5-01	5/32	1/16-27
02.5-02	5/32	1/8-27
03-02	3/16	1/8-27
04-02	1/4	1/8-27
04-04	1/4	1/4-18
04-06	1/4	3/8-18
06-02	3/8	1/8-27
06-04	3/8	1/4-18
06-06	3/8	3/8-18
06-08	3/8	1/2-14
08-04	1/2	1/4-18
08-06	1/2	3/8-18
08-08	1/2	1/2-14
10-06	5/8	3/8-18
10-08	5/8	1/2-14
12-12	3/4	3/4-14

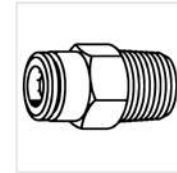

1568

AVAILABILITY

» Brass

Tube to Pipe Elbow 90°

SHAPE

90 degree elbow

Dash Size	Push-In DOT	Male Pipe
02.5-02	5/32	1/8-27
03-02	3/16	1/8-27
04-02	1/4	1/8-27
04-04	1/4	1/4-18
04-06	1/4	3/8-18
06-04	3/8	1/4-18
06-06	3/8	3/8-18
06-08	3/8	1/2-14
08-04	1/2	1/4-18
08-06	1/2	3/8-18
08-08	1/2	1/2-14
10-06	5/8	3/8-18
10-08	5/8	1/2-14
12-12	3/4	3/4-14



1569

AVAILABILITY

» Brass

Tube to Female Pipe Elbow 90°

SHAPE

90 degree elbow

Dash Size	Push-In DOT	Female Pipe
04-02	1/4	1/8-27
04-04	1/4	1/4-18
04-06	1/4	3/8-18
06-04	3/8	1/4-18
06-06	3/8	3/8-18
08-08	1/2	1/2-14



1570

AVAILABILITY

» Brass

1571



Tube to Pipe Swivel Run Tee

SHAPE

Tee

Dash Size	Push-In DOT	Male Pipe Swivel	Push-In DOT
04-02-04	1/4	1/8-27	1/4
04-04-04	1/4	1/4-18	1/4
06-04-06	3/8	1/4-18	3/8
06-06-06	3/8	3/8-18	3/8
08-06-08	1/2	3/8-18	1/2

AVAILABILITY

» Brass

1572



Tube to Pipe Swivel Branch Tee

SHAPE

Tee

Dash Size	Push-In DOT	Push-In DOT	Male Pipe Swivel
03-03-02	3/16	3/16	1/8-27
04-04-02	1/4	1/4	1/8-27
04-04-04	1/4	1/4	1/4-18
06-06-04	3/8	3/8	1/4-18
06-06-06	3/8	3/8	3/8-18
08-08-04	1/2	1/2	1/4-18
08-08-06	1/2	1/2	3/8-18

AVAILABILITY

» Brass

1577



Tube to Pipe Branch Tee

SHAPE

Tee

Dash Size	Push-In DOT	Push-In DOT	Female Pipe
04-04-02	1/4	1/4	1/8-27
04-04-04	1/4	1/4	1/4-18
06-06-04	3/8	3/8	1/4-18

AVAILABILITY

» Brass

1579



Tube to Pipe Swivel Elbow 90°

SHAPE

90 degree elbow

Dash Size	Push-In DOT	Male Pipe Swivel
04-02	1/4	1/8-27
04-04	1/4	1/4-18
04-06	1/4	3/8-18
06-02	3/8	1/8-27
06-04	3/8	1/4-18
06-06	3/8	3/8-18
06-08	3/8	1/2-14
08-06	1/2	3/8-18
08-08	1/2	1/2-14
10-06	5/8	3/8-18
10-08	5/8	1/2-14
12-12	3/4	3/4-14

AVAILABILITY

» Brass

Tube Bulkhead Union

SHAPE

Straight

Dash Size	Push-In DOT	Push-In DOT
04-04	1/4	1/4
06-06	3/8	3/8
08-08	1/2	1/2
10-10	5/8	5/8

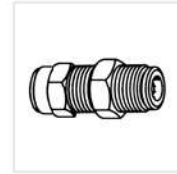

1582

AVAILABILITY

» Brass

Brass Garden Hose Fittings

4024

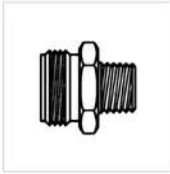

GHT to Pipe

SHAPE

Straight

Dash Size	Male Garden Hose	Male Pipe
12-06	3/4" Garden Hose	3/8-18
12-08	3/4" Garden Hose	1/2-14
12-12	3/4" Garden Hose	3/4-14

AVAILABILITY

» Brass

4025

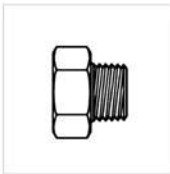

GHT to Pipe

SHAPE

Straight

Dash Size	Female Garden Hose	Male Pipe
12-06	3/4" Garden Hose	3/8-18
12-08	3/4" Garden Hose	1/2-14
12-12	3/4" Garden Hose	3/4-14

AVAILABILITY

» Brass

4026



GHT to Pipe

SHAPE

Straight

Dash Size	Male Garden Hose	Female Pipe
12-04	3/4" Garden Hose	1/4-18
12-06	3/4" Garden Hose	3/8-18
12-08	3/4" Garden Hose	1/2-14
12-12	3/4" Garden Hose	3/4-14

AVAILABILITY

» Brass

4030

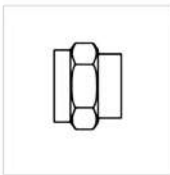

GHT to Pipe

SHAPE

Straight

Dash Size	Female Garden Hose	Female Pipe
12-04	3/4" Garden Hose	1/4-18
12-06	3/4" Garden Hose	3/8-18
12-08	3/4" Garden Hose	1/2-14
12-12	3/4" Garden Hose	3/4-14

AVAILABILITY

» Brass

4040



GHT Swivel Union

SHAPE

Straight

Dash Size	Female Garden Hose Swivel	Female Garden Hose Swivel
12-12	3/4" Garden Hose	3/4" Garden Hose

AVAILABILITY

» Brass

GHT Swivel to Pipe

SHAPE Straight

Dash Size	Female Garden Hose Swivel	Male Pipe
12-04	3/4" Garden Hose	1/4-18
12-06	3/4" Garden Hose	3/8-18
12-08	3/4" Garden Hose	1/2-14

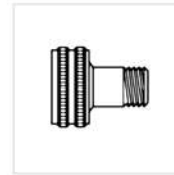

4044

AVAILABILITY
» Brass

GHT Swivel to Pipe

SHAPE Straight

Dash Size	Female Garden Hose Swivel	Female Pipe
12-04	3/4" Garden Hose	1/4-18
12-08	3/4" Garden Hose	1/2-14
12-12	3/4" Garden Hose	3/4-14

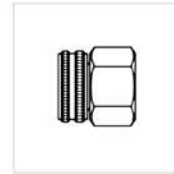

4045

AVAILABILITY
» Brass

GHT Union

SHAPE Straight

Dash Size	Male Garden Hose	Male Garden Hose
12-12	3/4" Garden Hose	3/4" Garden Hose

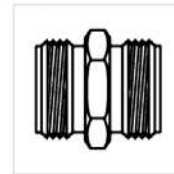

4050

AVAILABILITY
» Brass

GHT Hose Barb Assembly

SHAPE Straight

Dash Size	Hose Barb	Male Garden Hose	Female Garden Hose Swivel	Hose Barb
06-12-12-06	3/8	3/4" Garden Hose	3/4" Garden Hose	3/8
08-12-12-08	1/2	3/4" Garden Hose	3/4" Garden Hose	1/2
10-12-12-10	5/8	3/4" Garden Hose	3/4" Garden Hose	5/8
12-12-12-12	3/4	3/4" Garden Hose	3/4" Garden Hose	3/4
16-16-16-16	1	1" Garden Hose	1" Garden Hose	1

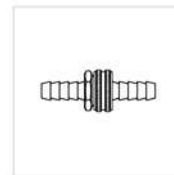

4100

AVAILABILITY
» Brass

Long Shank Garden Hose Barb (GHB) Assembly

SHAPE Straight

Dash Size	Hose Barb	Male Garden Hose	Female Garden Hose Swivel	Hose Barb
10-12-12-10	5/8	3/4" Garden Hose	3/4" Garden Hose	5/8
12-12-12-12	3/4	3/4" Garden Hose	3/4" Garden Hose	3/4

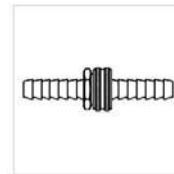

4100-L

AVAILABILITY
» Brass

4144



Garden Hose Barb (GHB) to GHT

SHAPE Straight

Dash Size	Hose Barb	Male Garden Hose
06-12	3/8	3/4" Garden Hose
08-12	1/2	3/4" Garden Hose
10-12	5/8	3/4" Garden Hose
12-12	3/4	3/4" Garden Hose
16-16	1	1" Garden Hose

AVAILABILITY

» Brass

4144-L



Long Shank Garden Hose Barb (GHB) to GHT

SHAPE Straight

Dash Size	Hose Barb	Male Garden Hose
08-12	1/2	3/4" Garden Hose
10-12	5/8	3/4" Garden Hose
12-12	3/4	3/4" Garden Hose

AVAILABILITY

» Brass

4145



Garden Hose Barb (GHB) to GHT

SHAPE Straight

Dash Size	Hose Barb	Female Garden Hose Swivel
06-12	3/8	3/4" Garden Hose
08-12	1/2	3/4" Garden Hose
10-12	5/8	3/4" Garden Hose
12-12	3/4	3/4" Garden Hose
16-16	1	1" Garden Hose

AVAILABILITY

» Brass

4145-L



Long Shank Garden Hose Barb (GHB) to GHT

SHAPE Straight

Dash Size	Hose Barb	Female Garden Hose Swivel
10-12	5/8	3/4" Garden Hose
12-12	3/4	3/4" Garden Hose

AVAILABILITY

» Brass

GHW



Garden Hose Washer

Available in black or red. Plasticized rubber.

SHAPE Washer

Dash Size	Thread 1 Nominal Size
10	10

AVAILABILITY

» Plastic



BALL VALVES

FBV



Full Port Ball Valve

- 1/4" - 4"
- For Use with Wide Range of Liquids and Gases
- Threaded - Two-Piece Body - Full Port - Blow-out Proof Stem - Adjustable Stem Packing Nut - PTFE Seats
- NPTF Threads

SHAPE Straight

OPERATING TEMPERATURE RANGE 0° F to 400° F

STYLE Full-Port

HANDLE TYPE 1/4 Turn Vinyl Insulated Carbon Steel

Dash Size	Female Pipe	Female Pipe	Pressure Rating
04-04	1/4-18	1/4-18	600 PSI Non-Shock / 150 WSP Saturated Steam
06-06	3/8-18	3/8-18	600 PSI Non-Shock / 150 WSP Saturated Steam
08-08	1/2-14	1/2-14	600 PSI Non-Shock / 150 WSP Saturated Steam
12-12	3/4-14	3/4-14	600 PSI Non-Shock / 150 WSP Saturated Steam
16-16	1-11 1/2	1-11 1/2	600 PSI Non-Shock / 150 WSP Saturated Steam
20-20	1 1/4-11 1/2	1 1/4-11 1/2	600 PSI Non-Shock / 150 WSP Saturated Steam
24-24	1 1/2-11 1/2	1 1/2-11 1/2	600 PSI Non-Shock / 150 WSP Saturated Steam
32-32	2-11 1/2	2-11 1/2	600 PSI Non-Shock / 150 WSP Saturated Steam
40-40	2 1/2-8	2 1/2-8	400 PSI Non-Shock / 150 WSP Saturated Steam
48-48	3-8	3-8	400 PSI Non-Shock / 150 WSP Saturated Steam
64-64	4-8	4-8	400 PSI Non-Shock / 150 WSP Saturated Steam

AVAILABILITY

» Brass

MBV-FF

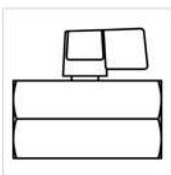

Female x Female Mini Ball Valve

- Chrome Plated Brass
- Threaded
- One-Piece
- Reduced Port
- Double O-Ring Packing
- Blowout-Proof Stem
- PTFE Seats

SHAPE Straight

PRESSURE RATING 450 PSI WOG Rated (32 Bar)

OPERATING TEMPERATURE RANGE -4° F to 212° F

STYLE Mini

HANDLE TYPE 1/4 Turn Aluminum

Dash Size	Female Pipe	Female Pipe
02-02	1/8-27	1/8-27
04-04	1/4-18	1/4-18
06-06	3/8-18	3/8-18
08-08	1/2-14	1/2-14
12-12	3/4-14	3/4-14

AVAILABILITY

» Brass

Male x Female Mini Ball Valve

- Chrome Plated Brass
- Threaded
- One-Piece
- Reduced Port
- Double O-Ring Packing
- Blowout-Proof Stem
- PTFE Seats

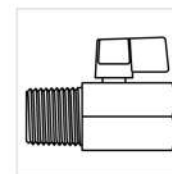
MBV-MF
AVAILABILITY

» Brass

SHAPE	Straight
PRESSURE RATING	450 PSI WOG Rated (32 Bar)
OPERATING TEMPERATURE RANGE	-4° F to 212° F
STYLE	Mini
HANDLE TYPE	1/4 Turn Aluminum

Dash Size	Male Pipe	Female Pipe
02-02	1/8-27	1/8-27
04-04	1/4-18	1/4-18
06-06	3/8-18	3/8-18
08-08	1/2-14	1/2-14

Female x Female Full Port Stainless Ball Valve

- 16 Stainless Steel Body, Ball and Stem
- PTFE Seats, Joint Gasket and Thrust Washer
- 304 Stainless Steel Handle With Blue Vinyl Insulator
- Blow-Out Proof Stem Design

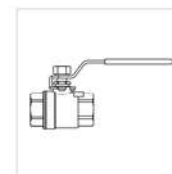
SS-FBV
AVAILABILITY

» Import Stainless Steel

SHAPE	Straight
PRESSURE RATING	1,000 PSI / 100 PSI Saturated Steam
OPERATING TEMPERATURE RANGE	-60° F to 450° F
STYLE	Full-Port
HANDLE TYPE	1/4 Turn Vinyl Insulated Stainless Steel

Dash Size	Female Pipe	Female Pipe
04-04	1/4-18	1/4-18
06-06	3/8-18	3/8-18
08-08	1/2-14	1/2-14
12-12	3/4-14	3/4-14
16-16	1-11 1/2	1-11 1/2
20-20	1 1/4-11 1/2	1 1/4-11 1/2
24-24	1 1/2-11 1/2	1 1/2-11 1/2
32-32	2-11 1/2	2-11 1/2
40-40	2 1/2-8	2 1/2-8
48-48	3-8	3-8

HPV



High Pressure Ball Valve

- NPTF Threads
- Rugged Carbon Steel Construction
- Mounting holes standard
- Blow-Out Proof Stems

AVAILABILITY

» Steel

SHAPE Straight

OPERATING TEMPERATURE RANGE -22° F to 212° F

STYLE Full-Port

HANDLE TYPE 1/4 Turn Vinyl Insulated Carbon Steel

Dash Size	Female Pipe	Female Pipe	Pressure Rating
04-04	1/4-18	1/4-18	7,250 PSI
06-06	3/8-18	3/8-18	7,250 PSI
08-08	1/2-14	1/2-14	7,250 PSI
12-12	3/4-14	3/4-14	5,800 PSI
16-16	1-11 1/2	1-11 1/2	5,000 PSI
20-20	1 1/4-11 1/2	1 1/4-11 1/2	5,000 PSI
32-32	2-11 1/2	2-11 1/2	5,000 PSI



HOSE PROTECTION

HP



Hose Protectors - single pack

Hose Protectors are durable wear shields made of an abrasion and hydrocarbon resistant material which is impervious to solvents, oils, grease and gasoline. They are highly abrasion resistant, with a wide range of operating temperatures (-40 degrees to 400 degrees F), and will protect your equipment in even the harshest of conditions. Easy installation in minutes, with no system disassembly required.

TYPE	Wrap
WORKING TEMPERATURE RANGE	-40 degrees F to 400 degrees F
HOSE PROTECTORS PER PACKAGE	1

SKU	Hose OD Size	Color	Size	Cable Ties Included
HP-4B	1/4" - 1"	Black	2.50"W X 4.00"L	(3) 7" long 75 lb. cable ties
HP-4Y	1/4" - 1"	Yellow	2.50"W X 4.00"L	(3) 7" long 75 lb. cable ties
HP-4O	1/4" - 1"	Orange	2.50"W X 4.00"L	(3) 7" long 75 lb. cable ties
HP-6B	3/4" - 1 1/4"	Black	3.25"W X 6.00"L	(3) 11" long 75 lb. cable ties
HP-6Y	3/4" - 1 1/4"	Yellow	3.25"W X 6.00"L	(3) 11" long 75 lb. cable ties
HP-6O	3/4" - 1 1/4"	Orange	3.25"W X 6.00"L	(3) 11" long 75 lb. cable ties
HP-8B	1" - 1 1/2"	Black	3.50"W X 8.00"L	(3) 11" long 75 lb. cable ties
HP-8Y	1" - 1 1/2"	Yellow	3.50"W X 8.00"L	(3) 11" long 75 lb. cable ties
HP-8O	1" - 1 1/2"	Orange	3.50"W X 8.00"L	(3) 11" long 75 lb. cable ties
HP-10B	1 1/4" - 2 1/4"	Black	4.50"W X 10.00"L	(4) 14" long 125 lb. cable ties
HP-10Y	1 1/4" - 2 1/4"	Yellow	4.50"W X 10.00"L	(4) 14" long 125 lb. cable ties
HP-10O	1 1/4" - 2 1/4"	Orange	4.50"W X 10.00"L	(4) 14" long 125 lb. cable ties
HP-12B	1 1/2" - 2 1/2"	Black	5.00"W X 12.00"L	(4) 14" long 125 lb. cable ties
HP-12Y	1 1/2" - 2 1/2"	Yellow	5.00"W X 12.00"L	(4) 14" long 125 lb. cable ties
HP-12O	1 1/2" - 2 1/2"	Orange	5.00"W X 12.00"L	(4) 14" long 125 lb. cable ties

HP-15PC



Hose Protectors - 15 pack

15 Hose Protectors and (60) 14" long 125 lb. cable ties in a display case. Three colors available.

TYPE	Wrap
WORKING TEMPERATURE RANGE	-40 degrees F to 400 degrees F
HOSE PROTECTORS PER PACKAGE	15
CABLE TIES INCLUDED	(60) 14" long 125 lb. cable ties in a display case

SKU	Hose OD Size	Color	Size
HP-10B-15PC	1 1/4" - 2 1/4"	Black	4.50"W X 10.00"L
HP-10O-15PC	1 1/4" - 2 1/4"	Orange	3.50"W X 8.00"L
HP-10Y-15PC	1 1/4" - 2 1/4"	Yellow	4.50"W X 10.00"L
HP-12B-15PC	1 1/2" - 2 1/2"	Black	5.00"W X 12.00"L
HP-12O-15PC	1 1/2" - 2 1/2"	Orange	5.00"W X 12.00"L
HP-12Y-15PC	1 1/2" - 2 1/2"	Yellow	5.00"W X 12.00"L

Hose Protectors - 50 pack

50 Hose Protectors and (150) cable ties in a display case. Available in three sizes for hose O.D. from 1/4" - 1 1/2". Three colors available.

TYPE	Wrap
WORKING TEMPERATURE RANGE	-40 degrees F to 400 degrees F
HOSE PROTECTORS PER PACKAGE	50

SKU	Hose OD Size	Color	Size	Cable Ties Included
HP-4B-50PC	1/4" - 1"	Black	2.50"W X 4.00"L	(150) 7" long 75 lb. cable ties in a display case
HP-4O-50PC	1/4" - 1"	Orange	2.50"W X 4.00"L	(150) 7" long 75 lb. cable ties in a display case
HP-4Y-50PC	1/4" - 1"	Yellow	2.50"W X 4.00"L	(150) 7" long 75 lb. cable ties in a display case
HP-6B-50PC	3/4" - 1 1/4"	Black	3.25"W X 6.00"L	(150) 11" long 75 lb. cable ties in a display case
HP-6O-50PC	3/4" - 1 1/4"	Orange	3.25"W X 6.00"L	(150) 11" long 75 lb. cable ties in a display case
HP-6Y-50PC	3/4" - 1 1/4"	Yellow	3.25"W X 6.00"L	(150) 11" long 75 lb. cable ties in a display case
HP-8B-50PC	1" - 1 1/2"	Black	3.50"W X 8.00"L	(150) 11" long 75 lb. cable ties in a display case
HP-8O-50PC	1" - 1 1/2"	Orange	3.50"W X 8.00"L	(150) 11" long 75 lb. cable ties in a display case
HP-8Y-50PC	1" - 1 1/2"	Yellow	3.50"W X 8.00"L	(150) 11" long 75 lb. cable ties in a display case



HP-50PC

Hose Protectors - Mixed 60 pack

Twenty (20) each of three sizes: 4", 6", and 8" hose protectors with cable ties. Packed in a display case. Three colors available.

TYPE	Wrap
HOSE OD SIZE	1/4" - 1 1/2"
WORKING TEMPERATURE RANGE	-40 degrees F to 400 degrees F
HOSE PROTECTORS PER PACKAGE	60 (20-4", 20-6", 20-8")
CABLE TIES INCLUDED	Cable ties and Display Case

SKU	Color
HPMB-60	Black
HPMY-60	Yellow
HPMO-60	Orange



HP-60

NHS



Protec Nylon Hose Sleeve

Protec is woven from thousands of nylon filaments and as it is scuffed and worn, its filaments form a thicker protective shield. It protects hose from abrasion and degradation and offers limited protection from the effects of hose bursting and pinhole occurrences. This smooth-bore sleeve allows bundling and is easily installed over hoses, chains, wires, cables or springs, and may be secured with nylon cable ties or band clamps.

Contact Tompkins Industries to ask us how to customize our No Lay Line products (e.g. NHS-125-NLL) with your company logo or brand name.

TYPE	Sleeve
WORKING TEMPERATURE RANGE	-40 degrees F to 194 degrees F
STANDARD PACKAGE	300'
WALL THICKNESS	.090 +/- .020, Double Flat
COLOR	Black

SKU	Outside Flat	Nominal ID
NHS-071	1.19	0.71
NHS-077	1.25	0.77
NHS-090	1.5	0.9
NHS-100	1.66	1.0
NHS-114	1.88	1.14
NHS-125	2.03	1.25
NHS-130	2.13	1.3
NHS-138	2.25	1.38
NHS-153	2.5	1.53
NHS-159	2.56	1.59
NHS-175	2.81	1.75
NHS-185	3.00	1.85
NHS-207	3.31	2.07
NHS-225	3.63	2.25
NHS-238	3.81	2.38
NHS-254	4.06	2.54
NHS-264	4.25	2.64
NHS-296	4.75	2.96
NHS-334	5.31	3.34
NHS-366	5.81	3.66
NHS-450	7.00	4.5

AVAILABILITY

» Nylon

ProWrap Plus Extreme Duty Hose and Cable Protection

Extend the life of expensive hydraulic hoses and cables with ProWrap Plus. It installs easily without disconnecting any lines. Wrap individual lines or bundle hoses. Use different colors to help match and identify lines. Sizes fit from 1/4" hose to 8" bundles.

- Dual-beveled edges ease installation and reduce risk of exposed sharp edges
- Bundled hoses may exit at any point
- Tight grip prevents sliding or leap-frogging

Manufactured from tough HDPE for ultimate protection against abrasive wear and crushing damage, it's resistant to chemical attack and suitable for use with all hydraulic fluids including glycol and phosphate ester based products.

Available in four colors: Black, Blue, Red and Yellow. Also available in flame resistant/anti-static versions.



PWP

AVAILABILITY

» Polyethylene

TYPE

Wrap

WORKING TEMPERATURE RANGE

-40 degrees F to 280 degrees F

SKU	Hose OD Size	Standard Package	Nominal ID	Wall Thickness	Color
PWP-12	3/8" - 7/16"	165'	0.38	.060	Black
PWP-16	7/16" - 5/8"	66'	0.49	.070	Black
PWP-16B	7/16" - 5/8"	66'	0.49	.070	Blue
PWP-16R	7/16" - 5/8"	66'	0.49	.070	Red
PWP-16Y	7/16" - 5/8"	66'	0.49	.070	Yellow
PWP-20	5/8" - 7/8"	66'	0.63	.080	Black
PWP-20B	5/8" - 7/8"	66'	0.63	.080	Blue
PWP-20R	5/8" - 7/8"	66'	0.63	.080	Red
PWP-20Y	5/8" - 7/8"	66'	0.63	.080	Yellow
PWP-25	7/8" - 1 3/8"	66'	0.83	.080	Black
PWP-25B	7/8" - 1 3/8"	66'	0.83	.080	Blue
PWP-25R	7/8" - 1 3/8"	66'	0.83	.080	Red
PWP-25Y	7/8" - 1 3/8"	66'	0.83	.080	Yellow
PWP-32	1 1/8" - 1 3/8"	66'	1.06	.100	Black
PWP-32B	1 1/8" - 1 3/8"	66'	1.06	.100	Blue
PWP-32R	1 1/8" - 1 3/8"	66'	1.06	.100	Red
PWP-32Y	1 1/8" - 1 3/8"	66'	1.06	.100	Yellow
PWP-40	1 1/2" - 1 5/8"	66'	1.34	.120	Black
PWP-40B	1 1/2" - 1 5/8"	66'	1.34	.120	Blue
PWP-40R	1 1/2" - 1 5/8"	66'	1.34	.120	Red
PWP-40Y	1 1/2" - 1 5/8"	66'	1.34	.120	Yellow
PWP-50	1 3/4" - 2 1/2"	66'	1.73	.160	Black
PWP-50B	1 3/4" - 2 1/2"	66'	1.73	.160	Blue
PWP-50R	1 3/4" - 2 1/2"	66'	1.73	.160	Red
PWP-50Y	1 3/4" - 2 1/2"	66'	1.73	.160	Yellow
PWP-63	2" - 3"	66'	2.17	.160	Black
PWP-63B	2" - 3"	66'	2.17	.160	Blue
PWP-63R	2" - 3"	66'	2.17	.160	Red
PWP-63Y	2" - 3"	66'	2.17	.160	Yellow
PWP-75	2 5/8" - 2 7/8"	66'	2.6	.180	Black
PWP-75B	2 5/8" - 2 7/8"	66'	2.6	.180	Blue
PWP-75Y	2 5/8" - 2 7/8"	66'	2.6	.180	Yellow
PWP-90	3" - 5"	66'	3.11	.220	Black
PWP-90Y	3" - 5"	66'	3.11	.220	Yellow
PWP-110	3 7/8" - 6"	40'	3.9	.220	Black

PWLD



AVAILABILITY
» Polyethylene

ProWrap Light Duty Hose and Cable Protection

Extends the life of expensive hydraulic hoses and cables. It installs easily without disconnecting any lines. Wrap individual lines or bundle hoses. Use different colors to help match and identify lines.

- Dual-beveled edges ease installation and reduce risk of exposed sharp edges
- Bundled hoses may exit at any point
- Tight grip prevents sliding or leap-frogging

More resistant to fire hazard than woven sleeve protectors that retain oil and sawdust, it's constructed of 100% polyethylene and is environmentally stable. It is immune to attack by most chemicals.

TYPE						Wrap
WORKING TEMPERATURE RANGE						-70 degrees F to 180 degrees F
COLOR						Black
SKU	Hose OD Size	Standard Package	Nominal ID	Maximum Bundle Diameter	Wall Thickness	
PWLD-16	1"	50'	1.0	2"	.110	
PWLD-20	1 1/4"	100'	1.25	2.5"	.135	
PWLD-24	1 1/2"	100'	1.5	3"	.145	
PWLD-32	2"	50'	2.0	4"	.175	
PWLD-56	3 1/2"	50'	3.5	7"	.190	
PWLD-96	6"	20'	6.0	11"	.185	

PWHD



AVAILABILITY
» Polyethylene

ProWrap Heavy Duty Hose and Cable Protection

Temperature range -70 degrees F to 180 degrees F. Sizes to fit 1/4" hose to 11" bundles.

Benefits:

- Extends the life of expensive hydraulic hoses and cables
- Install without disconnecting any lines
- Tight grip prevents sliding or leap-frogging
- Complete coverage with proper installation
- Bundled hoses may exit at any point

More resistant to fire hazard than woven sleeve protectors that retain oil and sawdust. 100% polyethylene and environmentally stable. It is immune to attack by most chemicals.

TYPE						Wrap
WORKING TEMPERATURE RANGE						-70 degrees F to 180 degrees F
COLOR						Black
SKU	Hose OD Size	Standard Package	Nominal ID	Maximum Bundle Diameter	Wall Thickness	
PWHD-08	1/2"	100'	0.5	1"	.095	
PWHD-12	3/4"	100'	0.75	1.5"	.125	
PWHD-16	1"	50'	1.0	2"	.170	
PWHD-20	1 1/2"	100'	1.25	2.5"	.200	
PWHD-24	1 1/2"	100'	1.5	3"	.230	
PWHD-32	2"	50'	2.0	4"	.260	
PWHD-48	3"	50'	3.0	6"	.240	
PWHD-64	4"	44'	4.0	8"	.290	
PWHD-96	6"	20'	6.0	11"	.270	

Fire Sleeve

A heat resistant silicone coated fiberglass sleeving, that protects hoses, cables and wires from molten metal splash, high heat hazards and occasional exposure to flame. Used in steel plants, glass plants, foundries, cutting and welding shops, and similar extreme environments.

Fire Sleeve withstands continuous exposure to 500 degrees F and short-term exposure up to 2200 degrees F. It is resistant to hydraulic fluids, fuels, and lubricating oils and remains extremely flexible and conformable throughout the entire size range at working temperatures.

It also reduces energy loss and offers personnel burn protection by insulating hot oil, steam lines or pipe surfaces.

Sold only in 50-foot rolls. No cuts.



PT

AVAILABILITY

» Silicone-coated
Fiberglass

TYPE	Sleeve
WORKING TEMPERATURE RANGE	-65 degrees F to 500 degrees F
STANDARD PACKAGE	50'
COLOR	Orange

SKU	Hose OD Size	Nominal ID	Wall Thickness
PT08100-10	1/2"	0.5	.125
PT10100-10	5/8"	0.625	.160
PT12100-10	3/4"	0.75	.135
PT14100-10	7/8"	0.875	.185
PT16100-10	1"	1.0	.145
PT18100-10	1 1/8"	1.125	.160
PT20100-10	1 1/4"	1.25	.160
PT22100-10	1 3/8"	1.375	.170
PT24100-10	1 1/2"	1.5	.160
PT26100-10	1 5/8"	1.625	.145
PT28100-10	1 3/4"	1.75	.170
PT30100-10	1 7/8"	1.875	.145
PT32100-10	2"	2.0	.190
PT36100-10	2 1/4"	2.25	.180
PT38100-10	2 3/8"	2.375	.160



QUICK DISCONNECTS

ANV

ANV-M

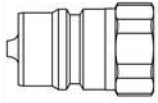

ANV Tips

ANV-08M-08FP is cross-listed as NV-08M-08FP. It will show on orders as NV-08M-08FP.

BODY STYLE

Tip

STANDARDS

ISO 7241-A

AVAILABILITY

» Steel

SKU	Dash Size	Female Pipe	Body Size	Interchange	Maximum Operating Pressure (PSI)	Coupled Burst Pressure (PSI)	Uncoupled Burst Pressure (PSI)
ANV-04M-04FP	04	1/4-18	1/4"	Aeroquip 5600, Parker 6600	5,075	18,270	18,270
ANV-06M-06FP	06	3/8-18	3/8"	Aeroquip 5600, Parker 6600	4,350	14,500	14,500
ANV-08M-08FP	08	1/2-14	1/2"	Aeroquip 5600, Parker 6600, Pioneer/Parker 4000, Pioneer/Parker 8000	3,625	11,600	11,600
ANV-12M-12FP	12	3/4-14	3/4"	Aeroquip 5600, Parker 6600	3,625	14,500	14,500
ANV-16M-16FP	16	1-11 1/2	1"	Aeroquip 5600, Parker 6600	3,335	11,600	11,600
ANV-20M-20FP	20	1 1/4-11 1/2	1 1/4"	Aeroquip 5600, Parker 6600	3,335	11,600	11,600
ANV-24M-24FP	24	1 1/2-11 1/2	1 1/2"	Aeroquip 5600, Parker 6600	2,610	9,280	9,280
ANV-32M-32FP	32	2-11 1/2	2"	Aeroquip 5600, Parker 6600	1,885	5,800	5,800

ANV-F

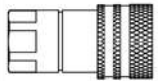

ANV Couplers

ANV-08F-08FP is cross-listed as NV-08F-08FP. It will show on orders as NV-08F-08FP.

BODY STYLE

Coupler

STANDARDS

ISO 7241-A

AVAILABILITY

» Steel

SKU	Dash Size	Female Pipe	Body Size	Interchange	Maximum Operating Pressure (PSI)	Coupled Burst Pressure (PSI)	Uncoupled Burst Pressure (PSI)
ANV-04F-04FP	04	1/4-18	1/4"	Aeroquip 5600, Parker 6600	5,075	18,270	18,270
ANV-06F-06FP	06	3/8-18	3/8"	Aeroquip 5600, Parker 6600	4,350	14,500	14,500
ANV-08F-08FP	08	1/2-14	1/2"	Aeroquip 5600, Parker 6600, Pioneer/Parker 4000, Pioneer/Parker 8000	3,625	11,600	11,600
ANV-12F-12FP	12	3/4-14	3/4"	Aeroquip 5600, Parker 6600	3,625	14,500	14,500
ANV-16F-16FP	16	1-11 1/2	1"	Aeroquip 5600, Parker 6600	3,335	11,600	11,600
ANV-20F-20FP	20	1 1/4-11 1/2	1 1/4"	Aeroquip 5600, Parker 6600	3,335	11,600	11,600
ANV-24F-24FP	24	1 1/2-11 1/2	1 1/2"	Aeroquip 5600, Parker 6600	2,610	9,280	9,280
ANV-32F-32FP	32	2-11 1/2	2"	Aeroquip 5600, Parker 6600	1,885	5,800	5,800

ANV Dust Caps

BODY STYLE

Cap

SKU	Body Size
ANV-04M-DUST CAP	1/4"
ANV-06M-DUST CAP	3/8"
ANV-12M-DUST CAP	3/4"
ANV-16M-DUST CAP	1"

ANV-DC
AVAILABILITY

» PVC/Rubber Blend

ANV Dust Plugs

BODY STYLE

Plug

SKU	Body Size
ANV-04F-DUST PLUG	1/4"
ANV-06F-DUST PLUG	3/8"
ANV-12F-DUST PLUG	3/4"
ANV-16F-DUST PLUG	1"

ANV-DP
AVAILABILITY

» PVC/Rubber Blend

NV

NV-M-FP

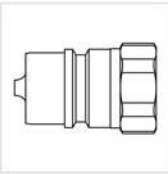

NV FP Tips

BODY STYLE

Tip

AVAILABILITY

» Steel

SKU	Dash Size	Female Pipe	Body Size	Interchange	Standards	Maximum Operating Pressure (PSI)	Coupled Burst Pressure (PSI)	Uncoupled Burst Pressure (PSI)
NV-04M-04FP	04	1/4-18	1/4"	Pioneer/Parker 4000, Pioneer/Parker 8000	ISO 5675	4,350	14,500	14,500
NV-06M-06FP	06	3/8-18	3/8"	Pioneer/Parker 4000, Pioneer/Parker 8000	ISO 5675	4,350	14,500	14,500
NV-08M-08FP	08	1/2-14	1/2"	Aeroquip 5600, Parker 6600, Pioneer/Parker 4000, Pioneer/Parker 8000	ISO 7241-A	3,625	11,600	11,600
NV-12M-12FP	12	3/4-14	3/4"	Pioneer/Parker 4000, Pioneer/Parker 8000	ISO 5675	3,625	13,050	13,050
NV-16M-16FP	16	1-11 1/2	1"	Pioneer/Parker 4000, Pioneer/Parker 8000	ISO 5675	2,900	11,600	11,600

NV-M-FB

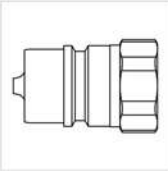

NV FB Tip

BODY STYLE

Tip

AVAILABILITY

» Steel

SKU	Dash Size	Female O-Ring	Body Size	Interchange	Standards	Maximum Operating Pressure (PSI)	Coupled Burst Pressure (PSI)	Uncoupled Burst Pressure (PSI)
NV-08M-08FB	08	3/4-16	1/2"	Aeroquip 5600, Parker 6600, Pioneer/Parker 4000, Pioneer/Parker 8000	ISO 7241-A	3,625	11,600	11,600

NV-F-FP

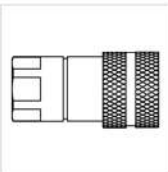

NV FP Couplers

BODY STYLE

Coupler

AVAILABILITY

» Steel

SKU	Dash Size	Female Pipe	Body Size	Interchange	Standards	Maximum Operating Pressure (PSI)	Coupled Burst Pressure (PSI)	Uncoupled Burst Pressure (PSI)
NV-04F-04FP	04	1/4-18	1/4"	Pioneer/Parker 4000, Pioneer/Parker 8000	ISO 5675	4,350	14,500	14,500
NV-06F-06FP	06	3/8-18	3/8"	Pioneer/Parker 4000, Pioneer/Parker 8000	ISO 5675	4,350	14,500	14,500

SKU	Dash Size	Female Pipe	Body Size	Interchange	Standards	Maximum Operating Pressure (PSI)	Coupled Burst Pressure (PSI)	Uncoupled Burst Pressure (PSI)
NV-08F-08FP	08	1/2-14	1/2"	Aeroquip 5600, Parker 6600, Pioneer/Parker 4000, Pioneer/Parker 8000	ISO 7241-A	3,625	11,600	14,500
NV-12F-12FP	12	3/4-14	3/4"	Pioneer/Parker 4000, Pioneer/Parker 8000	ISO 5675	3,625	13,050	14,500
NV-16F-16FP	16	1-11 1/2	1"	Pioneer/Parker 4000, Pioneer/Parker 8000	ISO 5675	2,900	11,600	11,600

NV-F-FP
▼ continued

NV FB Couplers

BODY STYLE

Coupler

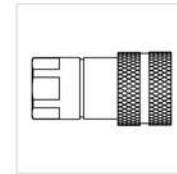

NV-F-FB

SKU	Dash Size	Female O-Ring	Body Size	Interchange	Standards	Maximum Operating Pressure (PSI)	Coupled Burst Pressure (PSI)	Uncoupled Burst Pressure (PSI)
NV-08F-08FB	08	3/4-16	1/2"	Aeroquip 5600, Parker 6600, Pioneer/Parker 4000, Pioneer/Parker 8000	ISO 7241-A	3,625	11,600	14,500

AVAILABILITY

» Steel

NV Dust Cap

BODY STYLE

Cap

SKU	Body Size
NV-04M-DUST CAP	1/4"
NV-06M-DUST CAP	3/8"
NV-08M-DUST CAP	1/2"
NV-12M-DUST CAP	3/4"
NV-16M-DUST CAP	1"



NV-DC

AVAILABILITY

» PVC/Rubber Blend

NV Dust Plug

BODY STYLE

Plug

SKU	Body Size
NV-04F-DUST PLUG	1/4"
NV-06F-DUST PLUG	3/8"
NV-08F-DUST PLUG	1/2"
NV-12F-DUST PLUG	3/4"
NV-16F-DUST PLUG	1"



NV-DP

AVAILABILITY

» PVC/Rubber Blend

HN

HN-M

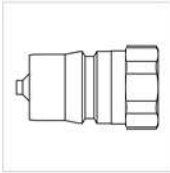

HN Tips

Also available in stainless steel upon request.

BODY STYLE

Tip

INTERCHANGE

Aeroquip FD45, Parker 60

STANDARDS

ISO 7241-B

SKU	Dash Size	Female Pipe	Body Size	Maximum Operating Pressure (PSI)	Coupled Burst Pressure (PSI)	Uncoupled Burst Pressure (PSI)
HN-02M-02FP	02	1/8-27	1/8"	5,075	17,400	17,400
HN-04M-04FP	04	1/4-18	1/4"	5,075	14,500	14,500
HN-06M-06FP	06	3/8-18	3/8"	4,350	14,500	14,500
HN-08M-08FP	08	1/2-14	1/2"	4,060	14,500	14,500
HN-12M-12FP	12	3/4-14	3/4"	4,000	14,500	14,500
HN-16M-16FP	16	1-11 1/2	1"	4,000	11,600	11,600
HN-20M-20FP	20	1 1/4-11 1/2	1 1/4"	2,500	10,000	10,000

AVAILABILITY

» Brass

HN-F

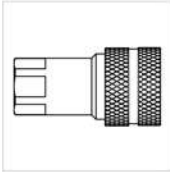

HN Couplers

Also available in stainless steel upon request.

BODY STYLE

Coupler

INTERCHANGE

Aeroquip FD45, Parker 60

STANDARDS

ISO 7241-B

SKU	Dash Size	Female Pipe	Body Size	Maximum Operating Pressure (PSI)	Coupled Burst Pressure (PSI)	Uncoupled Burst Pressure (PSI)
HN-02F-02FP	02	1/8-27	1/8"	5,075	17,400	17,400
HN-04F-04FP	04	1/4-18	1/4"	5,075	14,500	14,500
HN-06F-06FP	06	3/8-18	3/8"	4,350	14,500	14,500
HN-08F-08FP	08	1/2-14	1/2"	4,060	14,500	14,500
HN-12F-12FP	12	3/4-14	3/4"	4,000	14,500	14,500
HN-16F-16FP	16	1-11 1/2	1"	4,000	11,600	11,600
HN-20F-20FP	20	1 1/4-11 1/2	1 1/4"	2,500	10,000	10,000

AVAILABILITY

» Brass

HNV Dust Cap

BODY STYLE

Cap

SKU	Body Size
<i>HNV-04M-DUST CAP</i>	1/4"
<i>HNV-06M-DUST CAP</i>	3/8"
<i>HNV-08M-DUST CAP</i>	1/2"
<i>HNV-12M-DUST CAP</i>	3/4"
<i>HNV-16M-DUST CAP</i>	1"

HNV-DC
AVAILABILITY

» PVC/Rubber Blend

HNV Dust Plug

BODY STYLE

Plug

SKU	Body Size
<i>HNV-04F-DUST PLUG</i>	1/4"
<i>HNV-06F-DUST PLUG</i>	3/8"
<i>HNV-08F-DUST PLUG</i>	1/2"
<i>HNV-12F-DUST PLUG</i>	3/4"
<i>HNV-16F-DUST PLUG</i>	1"

HNV-DP
AVAILABILITY

» PVC/Rubber Blend

PVVM

PVVM-M

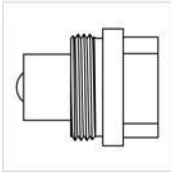

PVVM Tips

High Pressure Poppet Screw Together Coupling

BODY STYLE Tip

INTERCHANGE Enerpac, Hydraulic Jack, Parker 3000

MAXIMUM OPERATING PRESSURE (PSI) 10,000

SKU	Dash Size	Female Pipe	Body Size	Coupled Burst Pressure (PSI)
PVVM-04M-04FP	04	1/4-18	1/4"	35,714
PVVM-06M-06FP	06	3/8-18	3/8"	33,570

AVAILABILITY

» Steel

PVVM-F

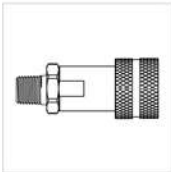

PVVM Couplers

High Pressure Poppet Screw Together Coupling

BODY STYLE Coupler

INTERCHANGE Enerpac, Hydraulic Jack, Parker 3000

MAXIMUM OPERATING PRESSURE (PSI) 10,000

SKU	Dash Size	Male Pipe	Body Size	Coupled Burst Pressure (PSI)
PVVM-04F-04MP	04	1/4-18	1/4"	35,714
PVVM-06F-06MP	06	3/8-18	3/8"	33,570

AVAILABILITY

» Steel

PVVM-DC



PVVM Dust Cap

BODY STYLE Cap

SKU	Body Size
PVVM-04F-DUST CAP	1/4"
PVVM-06F-DUST CAP	3/8"

AVAILABILITY

» Aluminum

PVVM-DP



PVVM Dust Plugs

BODY STYLE Plug

SKU	Body Size
PVVM-04M-DUST PLUG	1/4"
PVVM-06M-DUST PLUG	3/8"

AVAILABILITY

» Aluminum

TNV

TNV Tips

Also available in brass and stainless steel upon request.

BODY STYLE

Tip

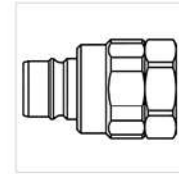

TNV-M

INTERCHANGE

Snaptite H Series, US Military Spec Mil-C-51234

SKU	Dash Size	Female Pipe	Body Size	Maximum Operating Pressure (PSI)	Coupled Burst Pressure (PSI)	Uncoupled Burst Pressure (PSI)
TNV-04M-04FP	04	1/4-18	1/4"	6,500	12,700	12,700
TNV-06M-06FP	06	3/8-18	3/8"	4,500	10,500	10,500
TNV-08M-08FP	08	1/2-14	1/2"	4,000	9,600	9,600
TNV-12M-12FP	12	3/4-14	3/4"	3,500	9,100	9,100
TNV-16M-16FP	16	1-11 1/2	1"	2,000	9,500	9,500
TNV-20M-20FP	20	1 1/4-11 1/2	1 1/4"	1,750	5,000	5,000

AVAILABILITY

» Steel

TNV Couplers

Also available in brass and stainless steel upon request.

BODY STYLE

Coupler

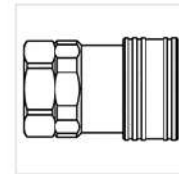

TNV-F

INTERCHANGE

Snaptite H Series, US Military Spec Mil-C-51234

SKU	Dash Size	Female Pipe	Body Size	Maximum Operating Pressure (PSI)	Coupled Burst Pressure (PSI)	Uncoupled Burst Pressure (PSI)
TNV-04F-04FP	04	1/4-18	1/4"	6,500	12,700	12,700
TNV-06F-06FP	06	3/8-18	3/8"	4,500	10,500	10,500
TNV-08F-08FP	08	1/2-14	1/2"	4,000	9,600	9,600
TNV-12F-12FP	12	3/4-14	3/4"	3,500	9,100	9,100
TNV-16F-16FP	16	1-11 1/2	1"	2,000	9,500	9,500
TNV-20F-20FP	20	1 1/4-11 1/2	1 1/4"	1,750	5,000	5,000

AVAILABILITY

» Steel

FFI

FFI-M-FP

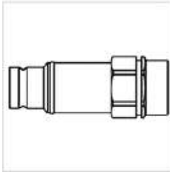

FFI FP Tips

BODY STYLE

Tip

AVAILABILITY

» Steel

SKU	Dash Size	Female Pipe	Body Size	Interchange	Standards	Maximum Operating Pressure (PSI)	Coupled Burst Pressure (PSI)	Uncoupled Burst Pressure (PSI)
FFI-04M-04FP	04	1/4-18	1/4"	Aeroquip FD89, Parker FEM	ISO 16028	6,090	18,270	18,270
FFI-06M-06FP	06	3/8-18	3/8"	Aeroquip FD99, Parker FEM	ISO 16028	4,785	14,500	14,500
FFI-06M-08FP	08	1/2-14	3/8"	Aeroquip FD99	ISO 16028	4,785	14,500	14,500
FFI-08M-08FP	08	1/2-14	1/2"	Aeroquip FD99, Parker FEM	ISO 16028	4,785	14,500	14,500
FFI-08M-12FP	12	3/4-14	1/2"	Aeroquip FD99, Parker FEM	ISO 16028	4,785	14,500	14,500
FFI-10M-12FP	12	3/4-14	5/8"	Aeroquip FD99	HTMA Standard, ISO 16028	4,785	14,500	14,500
FFI-12M-12FP	12	3/4-14	3/4"	Parker FEM	ISO 16028	4,785	14,500	14,500
FFI-16M-16FP	16	1-11 1/2	1"	Parker FEM	ISO 16028	4,350	11,600	11,600

FFI-M-FB

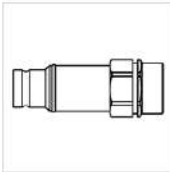

FFI FB Tips

BODY STYLE

Tip

AVAILABILITY

» Steel

SKU	Dash Size	Female O-Ring	Body Size	Interchange	Standards	Maximum Operating Pressure (PSI)	Coupled Burst Pressure (PSI)	Uncoupled Burst Pressure (PSI)
FFI-04M-06FB	06	9/16-18	1/4"	Aeroquip FD99, Parker FEM	ISO 16028	6,090	18,270	18,270
FFI-06M-06FB	06	9/16-18	3/8"	-	ISO 16028	4,785	14,500	14,500
FFI-06M-08FB	08	3/4-16	3/8"	Aeroquip FD99, Parker FEM	ISO 16028	4,785	14,500	14,500
FFI-08M-08FB	08	3/4-16	1/2"	-	ISO 16028	4,785	14,500	14,500
FFI-08M-10FB	10	7/8-14	1/2"	Aeroquip FD99, Parker FEM	ISO 16028	4,785	14,500	14,500
FFI-08M-12FB	12	1 1/16-12	1/2"	Aeroquip FD99, Parker FEM	ISO 16028	4,785	14,500	14,500
FFI-10M-12FB	12	1 1/16-12	5/8"	Aeroquip FD99, Parker FEM	HTMA Standard, ISO 16028	4,785	14,500	14,500
FFI-12M-12FB	12	1 1/16-12	3/4"	Parker FEM	ISO 16028	4,785	14,500	14,500
FFI-16M-16FB	16	1 5/16-12	1"	Parker FEM	ISO 16028	4,350	11,600	11,600

FFI FP Couplers

BODY STYLE

Coupler

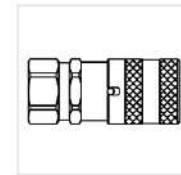

FFI-F-FP

AVAILABILITY

» Steel

SKU	Dash Size	Female Pipe	Body Size	Interchange	Standards	Maximum Operating Pressure (PSI)	Coupled Burst Pressure (PSI)	Uncoupled Burst Pressure (PSI)
FFI-04F-04FP	04	1/4-18	1/4"	Aeroquip FD99, Parker FEM	ISO 16028	6,090	18,270	18,270
FFI-06F-06FP	06	3/8-18	3/8"	Aeroquip FD99, Parker FEM	ISO 16028	4,785	14,500	14,500
FFI-06F-08FP	08	1/2-14	3/8"	Aeroquip FD99	ISO 16028	4,785	14,500	14,500
FFI-08F-08FP	08	1/2-14	1/2"	Aeroquip FD99, Parker FEM	ISO 16028	4,785	14,500	14,500
FFI-08F-12FP	12	3/4-14	1/2"	Aeroquip FD99, Parker FEM	ISO 16028	4,785	14,500	14,500
FFI-10F-12FP	12	3/4-14	5/8"	Aeroquip FD99	HTMA Standard, ISO 16028	4,785	14,500	14,500
FFI-12F-12FP	12	3/4-14	3/4"	Parker FEM	ISO 16028	4,785	14,500	14,500
FFI-16F-16FP	16	1-11 1/2	1"	Parker FEM	ISO 16028	4,350	11,600	11,600

FFI FB Couplers

BODY STYLE

Coupler

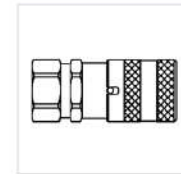

FFI-F-FB

AVAILABILITY

» Steel

SKU	Dash Size	Female O-Ring	Body Size	Interchange	Standards	Maximum Operating Pressure (PSI)	Coupled Burst Pressure (PSI)	Uncoupled Burst Pressure (PSI)
FFI-04F-06FB	06	9/16-18	1/4"	Aeroquip FD89, Parker FEM	ISO 16028	6,090	18,270	18,270
FFI-06F-06FB	06	9/16-18	3/8"	-	ISO 16028	4,785	14,500	14,500
FFI-06F-08FB	08	3/4-16	3/8"	Aeroquip FD99, Parker FEM	ISO 16028	4,785	14,500	14,500
FFI-08F-08FB	08	3/4-16	1/2"	-	ISO 16028	4,785	14,500	14,500
FFI-08F-10FB	10	7/8-14	1/2"	Aeroquip FD99, Parker FEM	ISO 16028	4,785	14,500	14,500
FFI-08F-12FB	12	1 1/16-12	1/2"	Aeroquip FD99, Parker FEM	ISO 16028	4,785	14,500	14,500
FFI-10F-12FB	12	1 1/16-12	5/8"	Aeroquip FD99, Parker FEM	HTMA Standard, ISO 16028	4,785	14,500	14,500
FFI-12F-12FB	12	1 1/16-12	3/4"	Parker FEM	ISO 16028	4,785	14,500	14,500
FFI-16F-16FB	16	1 5/16-12	1"	Parker FEM	ISO 16028	4,350	11,600	11,600

FFI-M-DC**FFI Male Dust Caps****BODY STYLE**

Cap

SKU	Body Size
<i>FFI-06M-DUST CAP</i>	<i>3/8"</i>
<i>FFI-08M-DUST CAP</i>	<i>1/2"</i>
<i>FFI-12M-DUST CAP</i>	<i>3/4"</i>
<i>FFI-16M-DUST CAP</i>	<i>1"</i>

AVAILABILITY

» PVC/Rubber Blend

FFI-F-DC**FFI Female Dust Caps****BODY STYLE**

Cap

SKU	Body Size
<i>FFI-06F-DUST CAP</i>	<i>3/8"</i>
<i>FFI-08F-DUST CAP</i>	<i>1/2"</i>
<i>FFI-12F-DUST CAP</i>	<i>3/4"</i>
<i>FFI-16F-DUST CAP</i>	<i>1"</i>

AVAILABILITY

» PVC/Rubber Blend

FB

FB Tips

BODY STYLE

Tip

INTERCHANGE

Aeroquip 5100, Parker 6100

SKU	Dash Size	Female Pipe	Body Size	Maximum Operating Pressure (PSI)	Coupled Burst Pressure (PSI)	Uncoupled Burst Pressure (PSI)
FB-12M-12FP	12	3/4-14	3/4"	3,000	9,000	9,000
FB-16M-16FP	16	1-11 1/2	1"	3,000	9,000	9,000
FB-20M-20FP	20	1 1/4-11 1/2	1 1/4"	2,750	8,250	8,250
FB-24M-24FP	24	1 1/2-11 1/2	1 1/2"	2,500	7,500	7,500

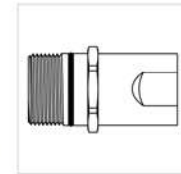
FB-M

AVAILABILITY

» Brass

FB Wing Nut Couplers

BODY STYLE

Coupler

INTERCHANGE

Aeroquip 5100, Parker 6100

SKU	Dash Size	Female Pipe	Body Size	Maximum Operating Pressure (PSI)	Coupled Burst Pressure (PSI)	Uncoupled Burst Pressure (PSI)
FB-12F-12FP	12	3/4-14	3/4"	3,000	9,000	9,000
FB-16F-16FP	16	1-11 1/2	1"	3,000	9,000	9,000
FB-20F-20FP	20	1 1/4-11 1/2	1 1/4"	2,750	8,250	8,250
FB-24F-24FP	24	1 1/2-11 1/2	1 1/2"	2,500	7,500	7,500

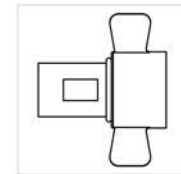
FB-F-WN

AVAILABILITY

» Brass

FB Hex Nut Couplers

BODY STYLE

Coupler

INTERCHANGE

Aeroquip 5100, Parker 6100

SKU	Dash Size	Female Pipe	Body Size	Maximum Operating Pressure (PSI)	Coupled Burst Pressure (PSI)	Uncoupled Burst Pressure (PSI)
FB-12F-12FP-HN	12	3/4-14	3/4"	3,000	9,000	9,000
FB-16F-16FP-HN	16	1-11 1/2	1"	3,000	9,000	9,000
FB-20F-20FP-HN	20	1 1/4-11 1/2	1 1/4"	2,750	8,250	8,250

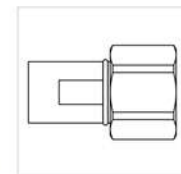
FB-F-HN

AVAILABILITY

» Brass

FB-DC



FB Dust Caps

BODY STYLE

Cap

SKU	Body Size
<i>FB-12M-DUST CAP</i>	<i>3/4"</i>
<i>FB-16M-DUST CAP</i>	<i>1"</i>
<i>FB-20M-DUST CAP</i>	<i>1 1/4"</i>
<i>FB-24M-DUST CAP</i>	<i>1 1/2"</i>

AVAILABILITY

» Brass

FB-DP



FB Dust Plugs

BODY STYLE

Plug

SKU	Body Size
<i>FB-12F-DUST PLUG</i>	<i>3/4"</i>
<i>FB-16F-DUST PLUG</i>	<i>1"</i>
<i>FB-20F-DUST PLUG</i>	<i>1 1/4"</i>
<i>FB-24F-DUST PLUG</i>	<i>1 1/2"</i>

AVAILABILITY

» Brass

PD

PD FP Tips

BODY STYLE

Tip

INTERCHANGE

Aeroquip FD90, Parker PD

SKU	Dash Size	Female Pipe	Body Size	Maximum Operating Pressure (PSI)	Coupled Burst Pressure (PSI)	Uncoupled Burst Pressure (PSI)
PD-02M-02FP	02	1/8-27	1/8"	6,000	18,700	24,000
PD-02M-04FP	04	1/4-18	1/8"	6,000	18,700	24,000

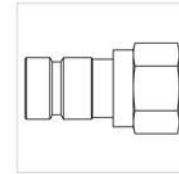

AVAILABILITY
» Steel

PD MB Tips

BODY STYLE

Tip

INTERCHANGE

Aeroquip FD90, Parker PD

SKU	Dash Size	Male O-Ring	Body Size	Maximum Operating Pressure (PSI)	Coupled Burst Pressure (PSI)	Uncoupled Burst Pressure (PSI)
PD-02M-04MB	04	7/16-20	1/8"	6,000	18,700	24,000
PD-02M-06MB	06	9/16-18	1/8"	6,000	18,700	24,000

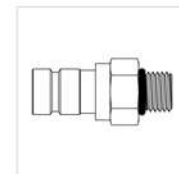

AVAILABILITY
» Steel

PD MP Tips

BODY STYLE

Tip

INTERCHANGE

Aeroquip FD90, Parker PD

SKU	Dash Size	Male Pipe	Body Size	Maximum Operating Pressure (PSI)	Coupled Burst Pressure (PSI)	Uncoupled Burst Pressure (PSI)
PD-02M-02MP	02	1/8-27	1/8"	6,000	18,700	24,000
PD-02M-04MP	04	1/4-18	1/8"	6,000	18,700	24,000

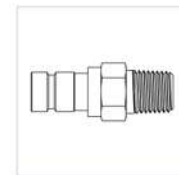

AVAILABILITY
» Steel

PD FP Couplers

BODY STYLE

Coupler

INTERCHANGE

Aeroquip FD90, Parker PD

SKU	Dash Size	Female Pipe	Body Size	Maximum Operating Pressure (PSI)	Coupled Burst Pressure (PSI)	Uncoupled Burst Pressure (PSI)
PD-02F-02FP	02	1/8-27	1/8"	6,000	18,700	18,700
PD-02F-04FP	04	1/4-18	1/8"	6,000	18,700	18,700

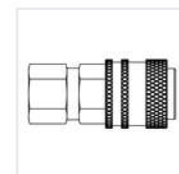

AVAILABILITY
» Steel

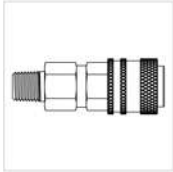

PD MP Couplers

BODY STYLE Coupler

INTERCHANGE Aeroquip FD90, Parker PD

SKU	Dash Size	Male Pipe	Body Size	Maximum Operating Pressure (PSI)	Coupled Burst Pressure (PSI)	Uncoupled Burst Pressure (PSI)
PD-02F-04MP	04	1/4-18	1/8"	6,000	18,700	18,700

AVAILABILITY

» Steel



PD Dust Caps

BODY STYLE Cap

SKU	Body Size
PD-02M-DUST CAP	1/8"

AVAILABILITY

» PVC/Rubber Blend

ST

ST FP Tips

Also available in stainless steel upon request.

BODY STYLE

Tip

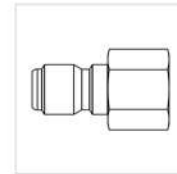

ST-M-FP

INTERCHANGE

Parker ST Series

SKU	Dash Size	Female Pipe	Body Size	Maximum Operating Pressure (PSI)	Coupled Burst Pressure (PSI)
ST-04M-04FP-S	04	1/4-18	1/4"	5,500	22,000
ST-06M-06FP-S	06	3/8-18	3/8"	4,500	18,300
ST-08M-08FP-S	08	1/2-14	1/2"	3,500	13,900
ST-12M-12FP-S	12	3/4-14	3/4"	3,100	12,900
ST-04M-04FP-B	04	1/4-18	1/4"	3,800	15,300
ST-06M-06FP-B	06	3/8-18	3/8"	3,000	14,100
ST-08M-08FP-B	08	1/2-14	1/2"	2,400	9,700
ST-12M-12FP-B	12	3/4-14	3/4"	2,000	8,700

AVAILABILITY

- » Steel
- » Brass

ST MP Tips

Also available in stainless steel upon request.

BODY STYLE

Tip

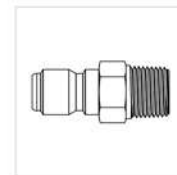

ST-M-MP

INTERCHANGE

Parker ST Series

SKU	Dash Size	Male Pipe	Body Size	Maximum Operating Pressure (PSI)	Coupled Burst Pressure (PSI)
ST-04M-04MP-S	04	1/4-18	1/4"	5,500	22,000
ST-06M-06MP-S	06	3/8-18	3/8"	4,500	18,300
ST-08M-08MP-S	08	1/2-14	1/2"	3,500	13,900
ST-12M-12MP-S	12	3/4-14	3/4"	3,100	12,900
ST-04M-04MP-B	04	1/4-18	1/4"	3,800	15,300
ST-06M-06MP-B	06	3/8-18	3/8"	3,000	14,100
ST-08M-08MP-B	08	1/2-14	1/2"	2,400	9,700
ST-12M-12MP-B	12	3/4-14	3/4"	2,000	8,700

AVAILABILITY

- » Steel
- » Brass

ST-F-FP

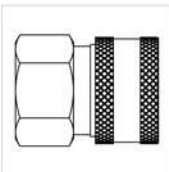

ST FP Couplers

Also available in stainless steel upon request.

BODY STYLE

Coupler

INTERCHANGE

Parker ST Series

AVAILABILITY

» Brass

SKU	Dash Size	Female Pipe	Body Size	Maximum Operating Pressure (PSI)	Coupled Burst Pressure (PSI)
ST-04F-04FP-B	04	1/4-18	1/4"	3,800	15,300
ST-06F-06FP-B	06	3/8-18	3/8"	3,000	14,100
ST-08F-08FP-B	08	1/2-14	1/2"	2,400	9,700
ST-12F-12FP-B	12	3/4-14	3/4"	2,000	8,700

ST-F-MP



ST MP Couplers

Also available in stainless steel upon request.

BODY STYLE

Coupler

INTERCHANGE

Parker ST Series

AVAILABILITY

» Brass

SKU	Dash Size	Male Pipe	Body Size	Maximum Operating Pressure (PSI)	Coupled Burst Pressure (PSI)
ST-04F-04MP-B	04	1/4-18	1/4"	3,800	15,300
ST-06F-06MP-B	06	3/8-18	3/8"	3,000	14,100
ST-08F-08MP-B	08	1/2-14	1/2"	2,400	9,700
ST-12F-12MP-B	12	3/4-14	3/4"	2,000	8,700



TEST POINTS & TEST KITS

Test Points

GCBP

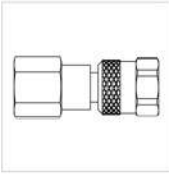

Gauge Connector - BSPP to Test Point

Dash Size	Female British Pipe Parallel	Female Test Point
04-M16X2.0	1/4-19	M16X2.0
08-M16X2.0	1/2-14	M16X2.0

AVAILABILITY

» Import Steel

GCP

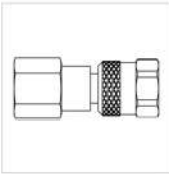

Gauge Connector - Pipe to Test Point

Dash Size	Female Pipe	Female Test Point
04-M16X2.0	1/4-18	M16X2.0

AVAILABILITY

Import Steel

GP6504

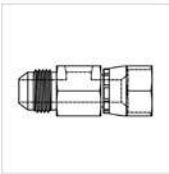

Gauge Port - JIC to JIC Swivel with -04 SAE O-Ring Port

Dash Size	Male JIC	Female JIC Swivel	Female O-Ring
04-04-04	7/16-20	7/16-20	7/16-20
06-06-04	9/16-18	9/16-18	7/16-20
08-08-04	3/4-16	3/4-16	7/16-20
10-10-04	7/8-14	7/8-14	7/16-20
12-12-04	1 1/16-12	1 1/16-12	7/16-20
16-16-04	1 5/16-12	1 5/16-12	7/16-20
20-20-04	1 5/8-12	1 5/8-12	7/16-20
24-24-04	1 7/8-12	1 7/8-12	7/16-20
32-32-04	2 1/2-12	2 1/2-12	7/16-20

AVAILABILITY

» Import Steel

GPFF2406

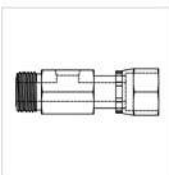

Gauge Port - ORFS to ORFS Swivel with -04 SAE O-Ring Port

Dash Size	Male O-Ring Face Seal	Female O-Ring Face Seal Swivel	Female O-Ring
04-04-04	9/16-18	9/16-18	7/16-20
06-06-04	11/16-16	11/16-16	7/16-20
08-08-04	13/16-16	13/16-16	7/16-20
10-10-04	1-14	1-14	7/16-20
12-12-04	1 3/16-12	1 3/16-12	7/16-20
16-16-04	1 7/16-12	1 7/16-12	7/16-20
20-20-04	1 11/16-12	1 11/16-12	7/16-20
24-24-04	2-12	2-12	7/16-20

AVAILABILITY

» Import Steel

Hose Gauge Connector - BSPP to Test Point Bulkhead with Nut

Dash Size	Female British Pipe Parallel	Male Test Point
04-M16X2.0	1/4-19	M16X2.0
08-M16X2.0	1/2-14	M16X2.0

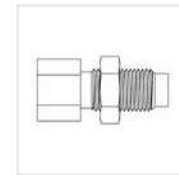

HGCBP

AVAILABILITY
» Import Steel

Hose Gauge Connector - Pipe to Test Point Bulkhead with Nut

Dash Size	Female Pipe	Male Test Point
04-M16X2.0	1/4-18	M16X2.0

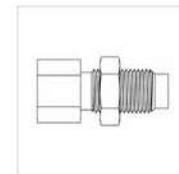

HGCP

AVAILABILITY
» Import Steel

Microbore Hose End - Flat Face Swivel

Dash Size	Female O-Ring Face Seal
04	9/16-18
06	11/16-16

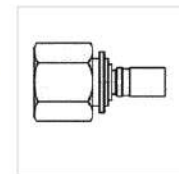

MBH FFX

AVAILABILITY
» Import Steel

Microbore Hose End - JIC Swivel

Dash Size	Female JIC Swivel
04	7/16-20
06	9/16-18

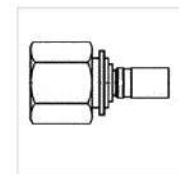

MBH FJX

AVAILABILITY
» Import Steel

Microbore Hose End - Pipe

Dash Size	Female Pipe
04	1/4-18

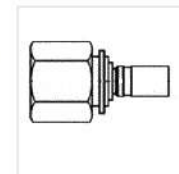

MBH FP

AVAILABILITY
» Import Steel

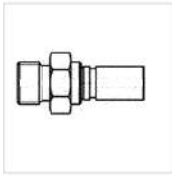

Microbore Hose End - Pipe

Dash Size	Male Pipe
02	1/8-27
04	1/4-18

AVAILABILITY

» Import Steel

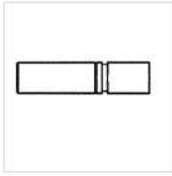

Microbore Hose End - Metric Standpipe

Dash Size	Metric Standpipe
06	6mm
08	8mm

AVAILABILITY

» Import Steel

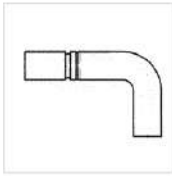

Microbore Hose End - Metric Standpipe 90° Elbow

Dash Size	Metric Standpipe
06	6mm
08	8mm

AVAILABILITY

» Import Steel

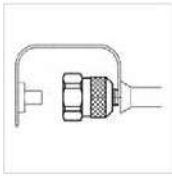

Microbore Hose End - Test Point

Dash Size	Female Test Point
M16X2.0	M16X2.0

AVAILABILITY

» Import Steel

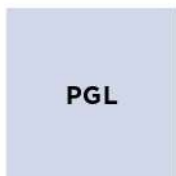

Pressure Gauge - Lower Mount

Gauge has a 2.5" Dial and -04 Male Pipe Lower Mount. Case and Ring are 304 Stainless Steel and Male Pipe is Extruded Brass.

SKU	PSI Range
PGL-LM25-MP4-00100-SS	0 - 100 PSI Single Scale
PGL-LM25-MP4-01000-SS	0 - 1000 PSI Single Scale
PGL-LM25-MP4-03000-SS	0 - 3000 PSI Single Scale
PGL-LM25-MP4-05000-SS	0 - 5000 PSI Single Scale
PGL-LM25-MP4-10000-SS	0 - 10,000 PSI Single Scale

AVAILABILITY

» Stainless Steel

Test Point - Test Point to Test Point Bulkhead with Nut

Dash Size	Male Metric	Male Metric
M16X2.0-M16X2.0	M16X2.0	M16X2.0

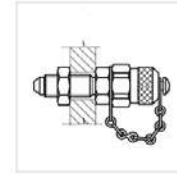

TPBH

AVAILABILITY
» Import Steel

Test Point - BSPP to Test Point

Dash Size	Male British Pipe Parallel	Male Test Point
02-M16X2.0	1/8-28	M16X2.0
04-M16X2.0	1/4-19	M16X2.0
06-M16X2.0	3/8-19	M16X2.0

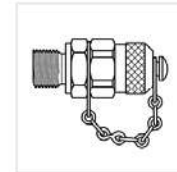

TPBP

AVAILABILITY
» Import Steel

Test Point - BSPT to Test Point

Dash Size	Male British Pipe Tapered	Male Test Point
02-M16X2.0	1/8-28	M16X2.0
04-M16X2.0	1/4-19	M16X2.0

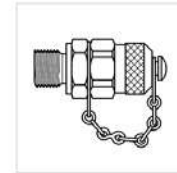

TPBT

AVAILABILITY
» Import Steel

Test Point to Test Point 90° Elbow

Dash Size	Female Test Point	Male Test Point
M16X2.0-M16X2.0	M16X2.0	M16X2.0

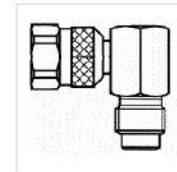

TPE

AVAILABILITY
» Import Steel

Test Point - ORFS Swivel to Test Point with Seal Retainer

Dash Size	Female O-Ring Face Seal Swivel	Male Test Point
04-M16X2.0	9/16-18	M16X2.0
06-M16X2.0	11/16-16	M16X2.0

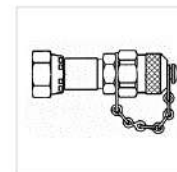

TPFF-O

AVAILABILITY
» Import Steel

TPFJ

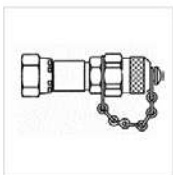

Test Point - JIC Swivel to Test Point

Dash Size	Female JIC Swivel	Male Test Point
04-M16X2.0	7/16-20	M16X2.0
05-M16X2.0	1/2-20	M16X2.0
06-M16X2.0	9/16-18	M16X2.0
08-M16X2.0	3/4-16	M16X2.0
10-M16X2.0	7/8-14	M16X2.0
12-M16X2.0	1 1/16-12	M16X2.0
16-M16X2.0	1 5/16-12	M16X2.0
20-M16X2.0	1 5/8-12	M16X2.0
24-M16X2.0	1 7/8-12	M16X2.0

AVAILABILITY

» Import Steel

TPJBH



Test Point - JIC to Test Point Bulkhead with Nut

Dash Size	Male JIC	Male Test Point
04-M16X2.0	7/16-20	M16X2.0

AVAILABILITY

» Import Steel

TPM

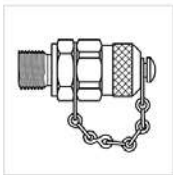

Test Point - Metric to Test Point

Dash Size	Male Metric	Male Test Point
08-M16X2.0	M8X1.0	M16X2.0
10-M16X2.0	M10X1.0	M16X2.0
12-M16X2.0	M12X1.5	M16X2.0
14-M16X2.0	M14X1.5	M16X2.0
16-M16X2.0	M16X1.5	M16X2.0

AVAILABILITY

» Import Steel

TPO

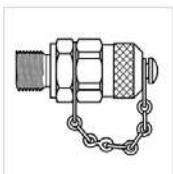

Test Point - O-Ring to Test Point

DO NOT USE TPO-04 with any GP or GPF (GP6504 and GPF2406) Gauge Port Fittings in size -04, -06 and -08. USE ONLY TPO-04-0 with these fittings in sizes 04,-06 AND -08.

Dash Size	Male O-Ring	Male Test Point
02-M16X2.0	5/16-24	M16X2.0
04-M16X2.0	7/16-20	M16X2.0
05-M16X2.0	1/2-20	M16X2.0
06-M16X2.0	9/16-18	M16X2.0
08-M16X2.0	3/4-16	M16X2.0

AVAILABILITY

» Import Steel

Test Point - Pipe to Test Point

Dash Size	Male Pipe	Male Test Point
02-M16X2.0	1/8-27	M16X2.0
04-M16X2.0	1/4-18	M16X2.0
06-M16X2.0	3/8-18	M16X2.0



AVAILABILITY
» Import Steel

Test Point - Metric Standpipe to Test Point

Dash Size	Metric Standpipe	Male Test Point
06-M16X2.0	6mm	M16X2.0
08-M16X2.0	8mm	M16X2.0
10-M16X2.0	10mm	M16X2.0
12-M16X2.0	12mm	M16X2.0

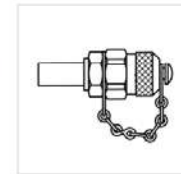

AVAILABILITY
» Import Steel

Test Point to Test Point (No Check Valve)

Dash Size	Male Test Point	Male Test Point
M16X2.0-M16X2.0	M16X2.0	M16X2.0

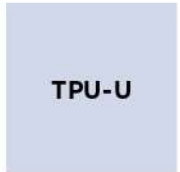
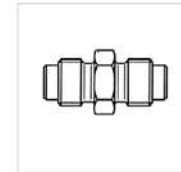

AVAILABILITY
» Import Steel

Test Point to Test Point (With Check Valve)

Dash Size	Male Test Point	Male Test Point
M16X2.0-M16X2.0	M16X2.0	M16X2.0



AVAILABILITY
» Import Steel

Microbore Hose Assembly - JIC To JIC

Custom hose assemblies are available; please call us with your requirements at 800-255-1008.

Dash Size	Female JIC	Female JIC	Length
04-04	7/16-20	7/16-20	12
04-04	7/16-20	7/16-20	18
04-04	7/16-20	7/16-20	24
04-04	7/16-20	7/16-20	40
04-04	7/16-20	7/16-20	60
04-04	7/16-20	7/16-20	72
04-04	7/16-20	7/16-20	96
04-04	7/16-20	7/16-20	120
04-04	7/16-20	7/16-20	240



AVAILABILITY
» Import Steel

MBH FP-FP



Microbore Hose Assembly - Pipe to Pipe

Custom hose assemblies are available; please call us with your requirements at 800-255-1008.

Dash Size	Female Pipe	Female Pipe	Length
04-04	1/4-18	1/4-18	12
04-04	1/4-18	1/4-18	18
04-04	1/4-18	1/4-18	24
04-04	1/4-18	1/4-18	40
04-04	1/4-18	1/4-18	60
04-04	1/4-18	1/4-18	72
04-04	1/4-18	1/4-18	96
04-04	1/4-18	1/4-18	240

AVAILABILITY

» Import Steel

MBH FP-TP



Microbore Hose Assembly - Pipe to Test Point

Custom hose assemblies are available; please call us with your requirements at 800-255-1008.

Dash Size	Female Pipe	Female Test Point
04-M16X2.0	1/4-18	M16X2.0

AVAILABILITY

» Import Steel

MBH TP-TP



Microbore Hose Assembly - Test Point to Test Point

Custom hose assemblies are available; please call us with your requirements at 800-255-1008.

Dash Size	Female Test Point	Female Test Point	Length
M16X2.0-M16X2.0	M16X2.0	M16X2.0	12
M16X2.0-M16X2.0	M16X2.0	M16X2.0	16
M16X2.0-M16X2.0	M16X2.0	M16X2.0	18
M16X2.0-M16X2.0	M16X2.0	M16X2.0	24
M16X2.0-M16X2.0	M16X2.0	M16X2.0	32
M16X2.0-M16X2.0	M16X2.0	M16X2.0	40
M16X2.0-M16X2.0	M16X2.0	M16X2.0	48
M16X2.0-M16X2.0	M16X2.0	M16X2.0	60
M16X2.0-M16X2.0	M16X2.0	M16X2.0	80
M16X2.0-M16X2.0	M16X2.0	M16X2.0	96
M16X2.0-M16X2.0	M16X2.0	M16X2.0	104
M16X2.0-M16X2.0	M16X2.0	M16X2.0	120
M16X2.0-M16X2.0	M16X2.0	M16X2.0	138
M16X2.0-M16X2.0	M16X2.0	M16X2.0	144

AVAILABILITY

» Import Steel

Test Point Kits

Test Point Kit – JIC Fittings

DIMENSIONS

15.8" x 12.1" x 6.8"

WEIGHT

4.4 lbs. (without components)



TPK-JIC KIT

CASE FEATURES

- Interiors are fully lined for greater scratch protection
- Strong, comfortable handles for easy carrying
- Heavy duty locking elbow hinges; Heavy duty opening hinges
- 17.5" x 13" convoluted foam interior for up to four pistols
- Exterior case measures 16.5" x 13" x 5" and weighs 7.5 lbs
- Two latches accept padlocks; Optional shoulder strap for easier carry

CASE INTERIOR

- Secure foam inserts
- Die-cut to match your kit items

The JIC Test Point Kit includes the items listed below.

Part	Description	QTY
GP6504-04-04	4MJ-4FJX w/ -4 SAE PORT	1
GP6504-06-06	6MJ-6FJX w/ -4 SAE PORT	1
GP6504-08-08	8MJ-8FJX w/ -4 SAE PORT	1
GP6504-10-10	10MJ-10FJX w/ -4 SAE PORT	1
GP6504-12-12	12MJ-12FJX w/ -4 SAE PORT	1
GP6504-16-16	16MJ-16FJX w/ -4 SAE PORT	1
GP6504-20-20	20MJ-20FJX w/ -4 SAE PORT	1
GP6504-24-24	24MJ-24FJX w/ -4 SAE PORT	1
HGCP-04	1/4 NPT Gauge Connector	1
PGL-LM25-MP4-01000-SS	GAUGE 1000 PSI 2.5" DIAL 4MP LOWER MOUNT	1
PGL-LM25-MP4-05000-SS	GAUGE 5000 PSI 2.5" DIAL 4MP LOWER MOUNT	1
TPP-04	1/4 NPT	1
TPO-04	4 Male O-Boss	1
TPM-10	10x1.0 MM	1
TPBP-04	1/4 BSPP	1
GCP-04	1/4 NPT Direct Gauge Connector	1
MBH-162-32	M16x2.0 Female x Female 32" Long	1

TPK-FF KIT



Test Point Kit - Flat Face Fittings

DIMENSIONS

15.8" x 12.1" x 6.8"

WEIGHT

4.4 lbs. (without components)

CASE FEATURES

- Interiors are fully lined for greater scratch protection
- Strong, comfortable handles for easy carrying
- Heavy duty locking elbow hinges; Heavy duty opening hinges
- 17.5" x 13" convoluted foam interior for up to four pistols
- Exterior case measures 16.5" x 13" x 5" and weighs 7.5 lbs
- Two latches accept padlocks; Optional shoulder strap for easier carry

CASE INTERIOR

- Secure foam inserts
- Die-cut to match your kit items

The O-Ring Face Seal Test Point Kit includes the items listed below.

Part	Description	QTY
GPFF2406-04-04	4MFF-4FFX w/ -4 SAE PORT	1
GPFF2406-06-06	6MFF-6FFX w/ -4 SAE PORT	1
GPFF2406-08-08	8MFF-8FFX w/ -4 SAE PORT	1
GPFF2406-10-10	10MFF-10FFX w/ -4 SAE PORT	1
GPFF2406-12-12	12MFF-12FFX w/ -4 SAE PORT	1
GPFF2406-16-16	16MFF-16FFX w/ -4 SAE PORT	1
GPFF2406-20-20	20MFF-20FFX w/ -4 SAE PORT	1
HGCP-04	1/4 NPT Gauge Connector	1
PGL-LM25-MP4-01000-SS	GAUGE 1000 PSI 2.5" DIAL 4MP LOWER MOUNT	1
PGL-LM25-MP4-05000-SS	GAUGE 5000 PSI 2.5" DIAL 4MP LOWER MOUNT	1
TPP-04	1/4 NPT	1
TPO-04	4 Male O-Boss	1
TPM-10	10x1.0 MM	1
TPBP-04	1/4 BSPP	1
GCP-04	1/4 NPT Direct Gauge Connector	1
MBH-162-32	M16x2.0 Female x Female 32" Long	1

Test Point Kit - Custom

Great for maintenance, monitoring, and emergency repair, a hydraulic test kit from Tompkins helps you maximize equipment up-time and quickly diagnose problems, should they occur. Best of all, with Tompkins you create your own hydraulic test kit, making it more affordable and applicable to your specific needs. Include only the components you need - test points, pressure gauges, hoses, gauge port adapters - for your operations.



**TPK-CUSTOM
KIT**

Your custom test kit includes a durable case with custom foam inserts and your selection of components.

YOU MAY CHOOSE FROM THE FOLLOWING COMPONENTS

- Male and Female Test Points
- Direct Gauge Connectors
- Hose Assembly
- Pressure Gauges
- Gauge Port Fittings
- Hose Gauge Connectors
- Metric Standpipe Test Points

Create your custom test kit online at tompkinsind.com.



AEROSOLS

TSL-104



Chain and Cable Spray Lubricant

This heavy-duty, multi-purpose lubricant is formulated to be the best available for rigorous industrial applications. A combination of superior corrosion-resistant, anti-wear, rust-preventive grease with effective penetrant provides the base. To this, the extreme lubricity and antifriction characteristics of Graphite and Molybdenum Disulfide ("Moly") are added. This custom formulation enables the lubricants to reach deep inside to the inner strands of cables and wire rope as well as the pins and rollers of industrial chains, where lubrication is critical. With proper application, it drastically reduces internal friction and extends the life of chains and cables by 200% or more.

Due to its water-repelling nature and rust-preventing features, this heavy duty chain and cable lubricant performs equally well outdoors.

Contains: Molybdenum Disulfide and Graphite.

USDA-H2 authorized and a product of the U.S.A.

Technical Data

PROPELLANT	Propane and n-Butane
FLASH POINT	430°F (221°C) Grease, typical
POUR POINT	10°F (-12°C) Grease, typical
SPRAY PATTERN	Shotgun Blast
VISCOSITY GREASE	300-350 SUS @ 100°F, typical
TEXTURE	Dark Grease with Fine MoS2 and Graphite Particulate
APPEARANCE	Black Grease
CONSISTENCY	Light
SPECIFIC GRAVITY	0.886 for Concentrate, typical
SIZE	11.0 oz.

EFFECTIVELY USE FOR

- » Construction equipment
- » Industrial chains
- » Farm machinery
- » Conveyor chains
- » Wire ropes and slings
- » Roller and lift chains on material handling equipment
- » Gates
- » Overhead cranes
- » Elevators
- » Tower cranes

TSL-108



Food and Beverage Dry-Glide Silicone

This dry-glide silicone is a premium quality aerosol silicone lubricant with a high percentage of premium quality food-grade silicone fluid — three times the percentage found in competitive sprays. The formula has been developed to be long-lasting and results-driven. It reduces friction, particularly between unlike surfaces or materials, and is especially effective for applications requiring dry and friction-free lubrication.

It is a long-lasting dry lubrication that will not attract dust, fibers or other potentially contaminating elements.

USDA-H1 authorized and a product of the U.S.A.

Technical Data

PROPELLANT	Propane and Butane
FLASH POINT	620°F (326°C) Silicone Fluid, typical -94°F (-70°C) Propellant, typical
POUR POINT	-85°F (-65°C) Silicone Fluid, typical
SPRAY PATTERN	Fine Mist
VISCOSITY	266 cSt @ 40°C Silicone Fluid
TEXTURE	Evaporating Mist
APPEARANCE	Clear
CONSISTENCY	Light
SPECIFIC GRAVITY	0.977 for Concentrate, typical
SIZE	10.0 oz.

EFFECTIVELY USE FOR

- » Hinges
- » Levers
- » Sliding mechanisms
- » Fork lift tines when unloading slip sheets
- » Zippers
- » Snaps
- » Bagging operations
- » Wrapping and packaging machinery
- » Protectant for leather, vinyl and rubber
- » Cutting blades

Non-Chlorinated Cleaner Degreaser

This non-chlorinated cleaner degreaser is an innovative, safe formulation of solvents and is extremely effective on tar, asphalt and concrete. It has become the sensible replacement for chlorinated cleaner/degreasers and offers the best characteristics of chlorinated solvents without the environmental roadblocks. With a Kauri-butanol value of 125, it demonstrates higher solvency power than some chlorinated solvents and much higher than HCFCs or mineral spirits. Combined with the benefits of complete evaporation, rapid dry time, no flash point, and low toxicity, it can become the answer for busy maintenance personnel and mechanics.

It effectively removes most oils, greases (except fluorinated), moly, graphite, and silicones. In addition, it affords the user compatibility with more metals, plastics, rings and seal materials than most other solvents. As with any solvent-based cleaner, it is recommended that, prior to use, you test the product on a small section of material.

USDA-K1 authorized, contains orange peel scent and is a product of the U.S.A.



TSL-211

Technical Data

PROPELLANT	Carbon Dioxide
FLASH POINT	No Flame Extension
SPRAY PATTERN	Stream
TEXTURE	Wet, but a Fast Flash Solvent
APPEARANCE	Clear Color, Orange Odor
CONSISTENCY	Light
SPECIFIC GRAVITY	1.30-1.34 for Concentrate, typical
SIZE	20.0 oz.

COMPATIBLE METALS

- » 3004H14 Aluminum
- » Beryllium
- » Bronze
- » Chromium
- » Copper
- » Lead
- » Nickel
- » 1010 Cold-Rolled Steel
- » 3042B Stainless Steel
- » Tin

COMPATIBLE PLASTICS

- » HDPE
- » Nylon
- » Mylar®
- » Ryton®
- » Polypropylene

INCOMPATIBLE PLASTICS

- » ABS
- » Acrylic
- » Lexan®
- » Polystyrene

COMPATIBLE ELASTOMERS

- » Butyl
- » Viton® A, B
- » Perfluoroelastomer
- » Polyether Urethane
- » Vinyl-Methyl Siloxane

INCOMPATIBLE ELASTOMERS

- » Buna-N
- » Neoprene
- » Polysiloxane
- » Polyurethane

TSL-229



Brake Parts Cleaner Non-Chlorinated

This cleaner quickly and safely removes brake fluid, oils, greases, dirt and other contaminants from brake and clutch parts, with or without disassembly. It cleans and degreases brake linings, drums, cylinders, springs, disc brake pads and other brake parts. It stops brake squeal for discs and drums and improves brake performance.

This cleaner contains no chlorinated solvents and is California low V.O.C compliant. Product of the U.S.A.

EFFECTIVELY USE FOR

- » Brake shoes
- » Rotors
- » Linings
- » Drums
- » Cylinders
- » Springs
- » Mechanisms
- » CV joints
- » Transmission and clutch parts
- » Cars, trucks, lift trucks and trailers

Technical Data

PROPELLANT	Carbon Dioxide
FLASH POINT	<0° F (-18° C), ASTM D 92
SPRAY PATTERN	Shotgun Blast
TEXTURE	Heavy Wet Quick Flash Solvent
APPEARANCE	Clear Liquid
CONSISTENCY	Light
SPECIFIC GRAVITY	0.73-0.75 for Concentrate, typical
SIZE	15.0 oz.



CLAMPS

WGC



Worm Gear Clamp

For common home and auto applications.

- Screw: 5/16" hex-head, plated carbon steel.
- Band: 1/2" width, 201/301 stainless steel.
- Housing: 201/301 stainless steel.

AVAILABILITY

» Steel

CLAMP TYPE

Worm Gear

SKU	Minimum Clamping Diameter	Maximum Clamping Diameter
WGC-04	0.25	0.625
WGC-06	0.313	0.875
WGC-08	0.437	1.00
WGC-10	0.50	1.06
WGC-104	5.00	7.00
WGC-12	0.50	1.25
WGC-16	0.688	1.50
WGC-20	0.75	1.75
WGC-24	1.00	2.00
WGC-28	1.25	2.25
WGC-32	1.50	2.50
WGC-36	1.75	2.75
WGC-40	2.00	3.00
WGC-44	2.25	3.25
WGC-48	2.50	3.50
WGC-56	3.00	4.00
WGC-60	2.25	4.25
WGC-64	2.50	4.50
WGC-72	3.00	5.00
WGC-80	3.25	5.25
WGC-88	4.00	6.00
WGC-96	4.5	6.50
WGC-128	6.50	8.50
WGC-188	9.375	12.25
WGC-248	13.125	16

TBC

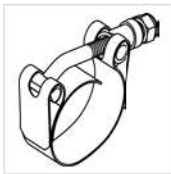

T-Bolt Clamps

Heavy duty T-bolt clamps provide uniform sealing pressure for a positive, reliable seal. They are specifically designed for use in high vibration and large diameter applications. Typical applications include truck air intake systems, cold side charge air systems, off-road equipment and industrial machinery.

AVAILABILITY

» Stainless Steel

CLAMP TYPE

T-Bolt

SKU	Minimum Clamping Diameter	Maximum Clamping Diameter
TBC131	1.25	1.41
TBC150	1.375	1.57
TBC163	1.50	1.69
TBC175	1.63	1.88
TBC188	1.69	1.94
TBC200	1.75	2.00
TBC213	1.88	2.19
TBC225	2.00	2.31
TBC238	2.13	2.44
TBC250	2.25	2.56
TBC256	2.31	2.62
TBC263	2.38	2.69
TBC275	2.52	2.81
TBC288	2.63	2.94
TBC300	2.75	3.06

SKU	Minimum Clamping Diameter	Maximum Clamping Diameter
TBC312	2.88	3.19
TBC325	3.00	3.31
TBC338	3.13	3.44
TBC350	3.25	3.56
TBC375	3.50	3.81
TBC400	3.77	4.06
TBC425	4.00	4.31
TBC450	4.25	4.56
TBC475	4.52	4.81
TBC500	4.75	5.06
TBC525	5.00	5.31
TBC550	5.25	5.56
TBC575	5.52	5.81
TBC600	5.75	6.06
TBC625	6.00	6.31
TBC650	6.27	6.56
TBC750	7.25	7.56

TBC
▼ continued

Supra Heavy-Duty T-Bolt Hose Clamp - Stainless Steel

The Supra W2 is a reliable, heavy-duty clamp that can be opened up and fastened again when in place without dislodging any other parts of the clamp. Its revolutionary swiveling bridge means it can be mounted in awkward applications without having to remove the hose. Beveled edges protect hoses from damage. The high-strength bolt, together with the captive nut and spacer system allow you to clamp the most demanding of hose assemblies.

CLAMP TYPE

Supra W2

SKU	Torque Inch (LBS)	Minimum Clamping Diameter	Maximum Clamping Diameter
SUPRA W2-075	88.50	0.67	0.75
SUPRA W2-080	88.50	0.75	0.83
SUPRA W2-090	88.50	0.83	0.91
SUPRA W2-100	88.50	0.91	0.98
SUPRA W2-105	88.50	0.98	1.06
SUPRA W2-115	88.50	1.06	1.14
SUPRA W2-120	115.10	1.14	1.22
SUPRA W2-125	115.10	1.22	1.34
SUPRA W2-140	115.10	1.34	1.46
SUPRA W2-150	115.10	1.46	1.57
SUPRA W2-165	115.10	1.57	1.69
SUPRA W2-175	141.60	1.69	1.85
SUPRA W2-200	141.60	1.85	2.01
SUPRA W2-215	141.60	2.01	2.17
SUPRA W2-225	141.60	2.17	2.32
SUPRA W2-238	141.60	2.32	2.48
SUPRA W2-250	141.60	2.48	2.68
SUPRA W2-275	265.50	2.68	2.87
SUPRA W2-300	265.50	2.87	3.11
SUPRA W2-325	265.50	3.11	3.35
SUPRA W2-350	265.50	3.35	3.58
SUPRA W2-375	265.50	3.58	3.82
SUPRA W2-400	265.50	3.82	4.09
SUPRA W2-425	265.50	4.09	4.41
SUPRA W2-475	265.50	4.41	4.76
SUPRA W2-500	265.50	4.76	5.12
SUPRA W2-550	398.30	5.12	5.51



SUPRA W2

AVAILABILITY
» Stainless Steel

▼ SUPRA W2 continues

SUPRA W2

▼ continued

SKU	Torque Inch (LBS)	Minimum Clamping Diameter	Maximum Clamping Diameter
SUPRA W2-575	398.30	5.51	5.91
SUPRA W2-600	398.30	5.91	6.38
SUPRA W2-650	398.30	6.38	6.85
SUPRA W2-700	398.30	6.85	7.36
SUPRA W2-750	398.30	7.36	7.87
SUPRA W2-800	398.30	7.87	8.39
SUPRA W2-850	398.30	8.39	8.90
SUPRA W2-900	398.30	8.90	9.41
SUPRA W2-950	398.30	9.41	9.92
SUPRA W2-1000	398.30	9.92	10.83
SUPRA W2-1075	398.30	10.83	10.94
SUPRA W2-1275	398.30	12.48	12.99

HK**Hose Clamp**

Used for support for long hose lengths. Also aids proper hose routing where abrasion or heat exists.

Material: ASTM A1008 CS type B Steel with 1/32" thick black vinyl cushion.

CLAMP TYPE

Hose

SKU	Minimum Clamping Diameter	Maximum Clamping Diameter	Bolt Hole Size
HK0413	0.187	0.187	13/32
HK0509	0.25	0.25	9/32
HK0511	0.25	0.25	11/32
HK0709	0.375	0.375	9/32
HK0713	0.375	0.375	13/32
HK0809	0.437	0.437	9/32
HK0913	0.50	0.50	13/32
HK0917	0.50	0.50	17/32
HK1013	0.562	0.562	13/32
HK1111	0.625	0.625	11/32
HK1113	0.625	0.625	13/32
HK1213	0.688	0.688	13/32
HK1313	0.75	0.75	13/32
HK1317	0.75	0.75	17/32
HK1413	0.812	0.812	13/32
HK1513	0.875	0.875	13/32
HK1613	0.937	0.937	13/32
HK1713	1.00	1.00	13/32
HK1813	1.06	1.06	13/32
HK1913	1.125	1.125	13/32
HK2017	1.187	1.187	17/32
HK2117	1.25	1.25	17/32
HK2317	1.375	1.375	17/32
HK2513	1.50	1.50	13/32
HK2517	1.50	1.50	17/32
HK2617	1.562	1.562	17/32
HK2913	1.75	1.75	13/32
HK2917	1.75	1.75	17/32
HK3117	1.88	1.88	17/32
HK3217	1.94	1.94	17/32
HK3317	2.00	2.00	17/32
HK3417	2.156	2.156	17/32
HK3817	2.656	2.656	17/32
HK4913	3.00	3.00	13/32
HK6513	4.00	4.00	13/32

AVAILABILITY

» Steel



HYDRAULIC TANK COMPONENTS

Hydraulic Tank Covers - Cleanout Covers

FCC-UP-BN

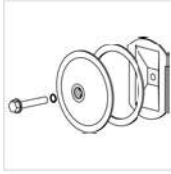

Cleanout Cover-Unplated Steel, Buna-N (Nitrile) Gasket

This is a patented design access cover offered by Tompkins Industries (US7721904 B). The self-centering anti-rotation inner plate does not drop during disassembly. Please see the website for more information.

GASKET TYPE

Buna-N Nitrile

SKU	Opening Diameter
FCC-06-UP-BN	5"
FCC-08-UP-BN	6"
FCC-10-UP-BN	8"
FCC-12-UP-BN	10"
FCC-14-UP-BN	12"

AVAILABILITY

» Unplated Steel

FCC-YZ-BN

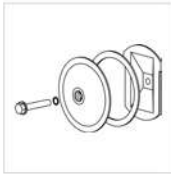

Cleanout Cover-Zinc Plated Steel, Buna-N (Nitrile) Gasket

This is a patented design access cover offered by Tompkins Industries (US7721904 B). The self-centering anti-rotation inner plate does not drop during disassembly. Please see the website for more information.

GASKET TYPE

Buna-N Nitrile

SKU	Opening Diameter
FCC-06-YZ-BN	5"
FCC-08-YZ-BN	6"
FCC-10-YZ-BN	8"
FCC-12-YZ-BN	10"
FCC-14-YZ-BN	12"

AVAILABILITY

» Zinc Plated Steel

FCC-YZ-SC

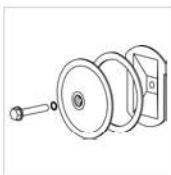

Cleanout Cover-Zinc Plated Steel, High Temp Silicone Gasket

This is a patented design access cover offered by Tompkins Industries (US7721904 B). The self-centering anti-rotation inner plate does not drop during disassembly. Please see the website for more information.

GASKET TYPE

High-temperature Silicone

SKU	Opening Diameter
FCC-06-YZ-SC	5"
FCC-08-YZ-SC	6"

AVAILABILITY

» Zinc Plated Steel

Tank Weld Flanges

O-Ring

Unplated steel.

SHAPE

Straight

Dash Size	Female O-Ring
04	7/16-20
05	1/2-20
06	9/16-18
08	3/4-16
10	7/8-14
12	1 1/16-12
14	1 3/16-12
16	1 5/16-12
20	1 5/8-12
24	1 7/8-12
32	2 1/2-12
48	3 1/2-12



TWF

AVAILABILITY

» Import Steel

NPT

Unplated steel.

SHAPE

Straight

Dash Size	Female Pipe
04	1/4-18
06	3/8-18
08	1/2-14
12	3/4-14
16	1-11 1/2
20	1 1/4-11 1/2
24	1 1/2-11 1/2
32	2-11 1/2
48	3-8



TWFN

AVAILABILITY

» Import Steel

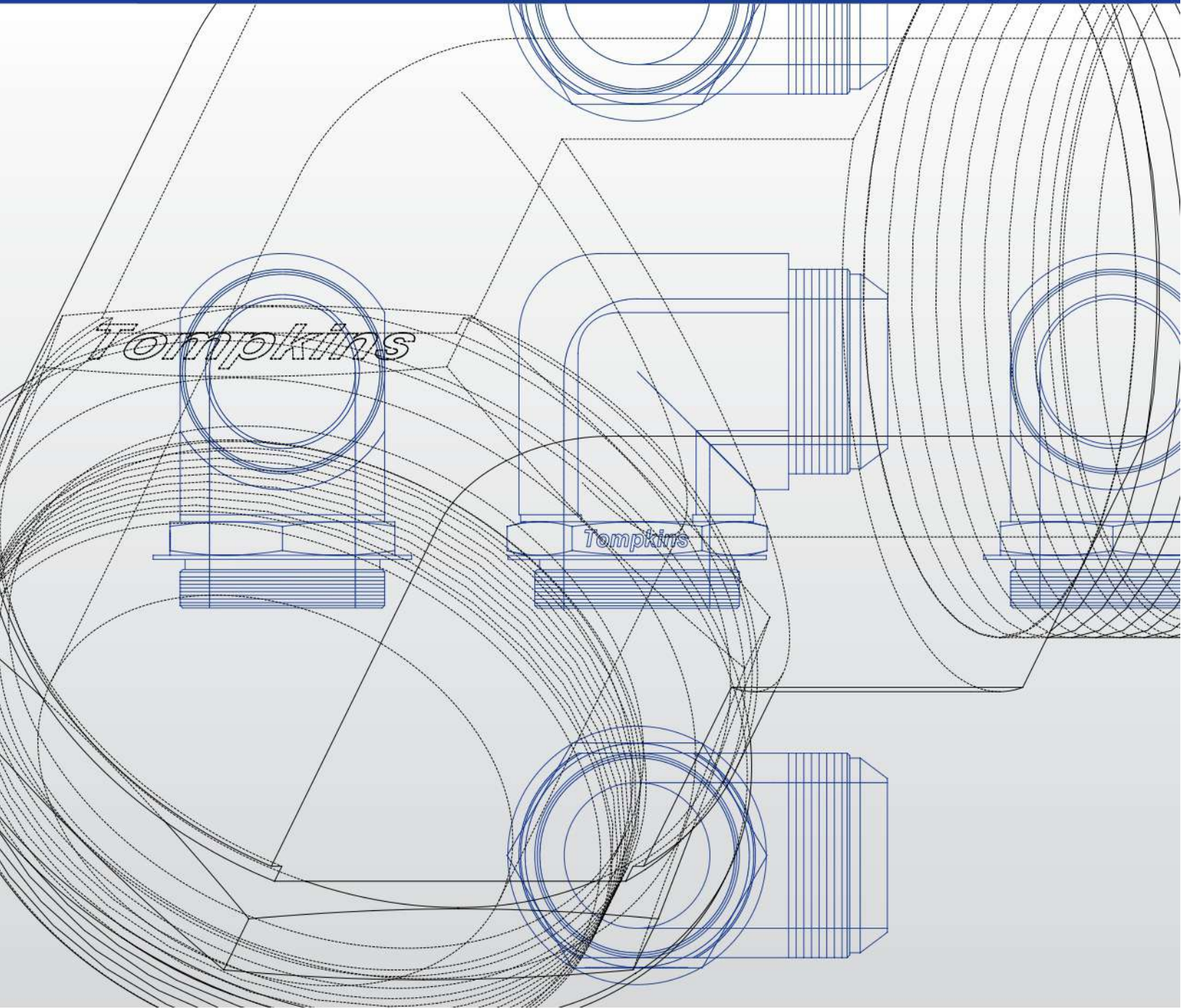

APPENDIX: TECHNICAL INFORMATION

About Working Pressure

The tables on the following pages list the recommended working pressure for a variety of hydraulic fittings made in accordance with world standards. Many factors such as impulse, vibration, mechanical shock, and improper assembly may affect the integrity of the fitting connection.

Tompkins Industries and SAE International™ recommend sufficient testing be conducted to ensure that performance levels will be safe and satisfactory, especially if installed in systems operating at elevated pressures or in severe conditions. Working pressure ratings are capable of a 4 to 1 minimum burst. All steel fittings meet or exceed the minimum SAE pressure ratings. Always consider application and maximum pressure requirements when selecting fittings.

WARNING: WHEN USING A FITTING WITH VARYING CONNECTION SIZES OR TYPES, DO NOT EXCEED THE WORKING PRESSURE OF THE LOWEST RATED CONNECTION END COMPRISING THE FITTING.

For pressures exceeding SAE standards, please contact the Tompkins Technical Staff.

Methods for Installing Fittings

There are three methods for installing a fitting:

- Torque wrench
- Flats From Wrench Resistance (FFWR)
- Turns From Finger Tight (TFFT)

For Flare and NPSM Fittings, Tompkins recommends the FFWR method be used whenever possible. When torque wrenches are not available or usable, use the FFWR method.

The differences in materials, plating, and surface finish impacts the coefficient of friction when installing or connecting fittings. To minimize these variances, Tompkins recommends that fitting connections are lubricated when installed. Connections that are lubricated provide a more accurate installation torque, which results in significantly fewer leaks.

Using a Torque Wrench

The torque values given in the tables on the following pages are for reference purposes only based on industry standard practice and for low carbon steel mating with steel/iron components. Actual torque values may need to be adjusted due to variances described above.

SAE recommends always making a wet (lubricated) installation or connection to reduce friction on moving parts, O-rings, and variances in material and plating. The torque values in these tables are based off SAE values using a .17 coefficient of friction as per SAE J2593. For torque on softer materials such as brass or aluminum, reduce the value in the table by 1/3. Example, 30 ft/lbs would be 20 ft/lbs. Many hydraulic leaks are a result of over-torque, which causes excessive deformation of material or exceeds the yield strength of the material, which may reduce the load or clamping force between seal contacts.

If more than one value or range is given, use the lower value first and increase only if required. Over-torquing can damage a fitting or mating component.

Using Turns From Finger Tight (TFFT) For Tapered Fittings

Turns From Finger Tight (TFFT) is the preferred method for tapered fittings such as NPT and BSPT. Taper threaded ports and fittings seal on the threads engaging each other, but do require a sealant to insure sealing.

NPT threaded connections can have a small void at the root/crest junction when external and internal thread flanks make contact. Without the application of a proper thread sealant to fill this void, a spiral leak path will occur.

On NPTF threads (Figure 2), the root and crest are machined with higher precision and a smaller tolerance enabling the flanks to contact more area, further minimizing the crest to root void. Even though NPTF threaded connections are more precise, they also require a thread sealant prior to installation to improve sealing.

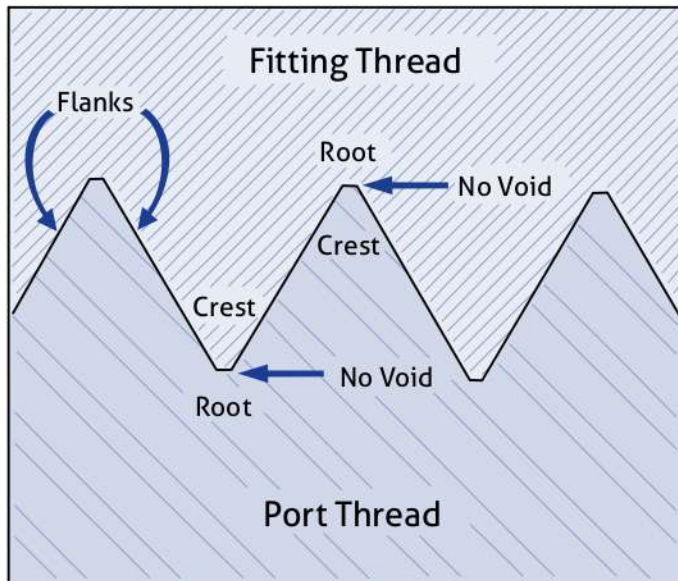

Figure 2 : NPTF Thread View

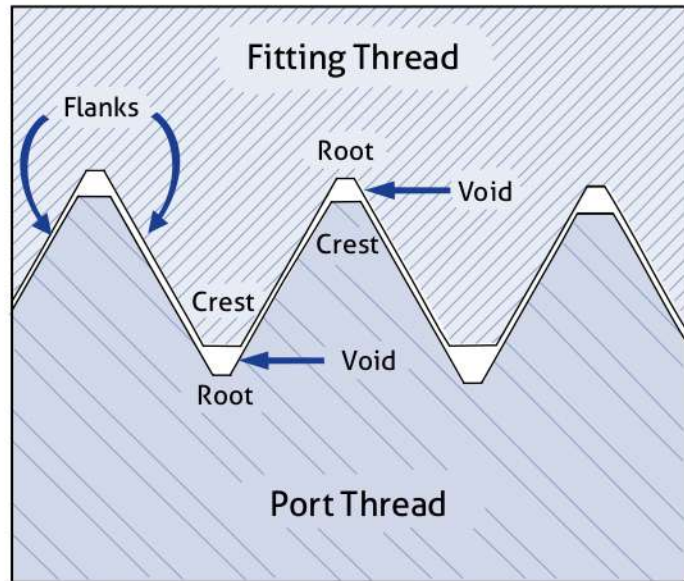

Figure 3 : NPT Thread View

BSPT and Metric tapered threads work and are installed in the same manner as NPT and NPTF. Confirm with the thread sealant supplier instructions that you are using the correct sealant for the application.

Because of the extent of variables involved in this type of seal such as material, type of sealant, thread quality and other factors, the TFFT method helps insure the correct torque is applied. This method focuses on the number of threads engaged rather than a set applied installation force (i.e. ft-lbs). From the point of finger tight is when the turns are counted. Then using a wrench, further tighten the fitting the correct number of turns or full revolutions from finger tight.

Visit the website at tompkinsind.com for more information about using our products, helpful assembly video information, product identification, CAD drawings and our wide range of product lines.

JIC Adapter Specifications

Male flared fittings include a conical nose with external threads for clamping.

A flared fitting or tube assembly is tightened against the cone with a swivel nut. By forcing the flare against the cone during the torquing process, the nose cone is slightly deformed and meshes to create a metal to metal seal between the flare and the cone.

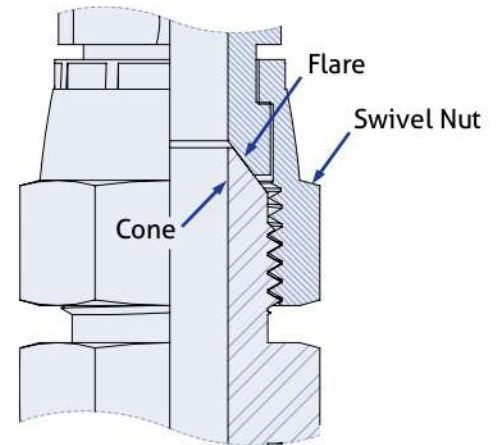

Figure 4: Flare Fitting Assembly

The following table lists the specifications for JIC adapters.

JIC Specifications							
Dash Size	Tube Size	Thread	Working Pressure		Torque		
			Male	Female Swivel Nut	JIC Rigid	JIC Swivel	Bulkhead Locknut
			(psi)	(psi)	(FFWR)	(FFWR)	(ft-lbs) +25% -0%
02	1/8	5/16-24	5000	5000	1/4 - 1/2	2	4
03	3/16	3/8-24	5000	5000	1/4 - 1/2	2	6
04	1/4	7/16-20	5000	4500	1/4 - 1/2	2	10
05	5/16	1/2-20	5000	4000	1/4 - 1/2	2	13
06	3/8	9/16-18	5000	4000	1/4 - 1/2	2	16
08	1/2	3/4-16	4500	4000	1/4 - 1/2	2	27
10	5/8	7/8-14	3500	3000	1/4 - 1/2	1 1/2	32
12	3/4	1-1/16-12	3500	3000	1/4 - 1/2	1 1/2	52
14	7/8	1-3/16-12	3000	2500	1/4 - 1/2	1 1/2	66
16	1	1-5/16-12	3000	2500	1/4 - 1/2	1 1/2	85
20	1 1/4	1-5/8-12	2500	2000	1/4 - 1/2	1	111
24	1 1/2	1-7/8-12	2000	1500	1/4 - 1/2	1	114
32	2	2-1/2-12	1500	1125	1/4 - 1/2	1	162

Values are per SAE J514

Tompkins does not recommend torque wrench installation of flared fittings. If you wish to use torque installation, contact Tompkins Technical Staff.

Table 1 : JIC Specifications

SAE O-Ring Boss Port Specifications

O-ring Boss ports (ORB) provide a seal by trapping the fitting's O-ring inside a port cavity. When a fitting is installed into the port, the O-ring is trapped between the fitting body hex or washer and port cavity.

Straight fittings include a hex, and sometimes an additional cylindrical shoulder below the hex and above the threads, to trap the O-ring in the port cavity.

Elbow and Tee fittings require a backup washer and a locknut above the O-ring on the threaded stud to permit a 360° orientation of the fitting around the port.

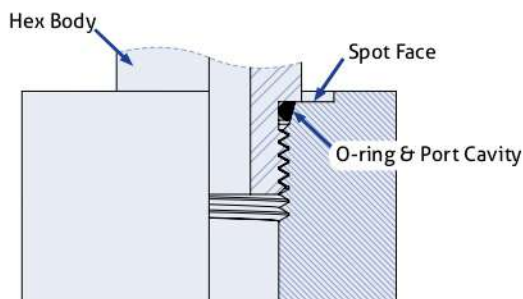

Figure 5 : Straight SAE ORB

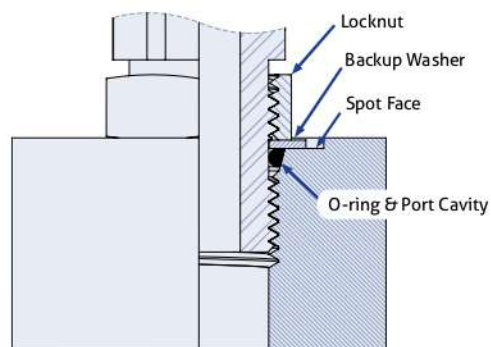

Figure 6: Adjustable SAE ORB

The following table lists the specifications for SAE O-Ring Boss Ports.

SAE O-Ring Boss Specifications										
Dash Size	Tube Size	Thread	SAE-ORB to JIC and Pipe Fittings*			SAE-ORB to ORFS Fittings**				
			Torque		Working Pressure		Torque		Working Pressure	
			Adjustable & Non-Adjustable		Adjustable	Non-Adjustable	Adjustable & Non-Adjustable		Adjustable	Non-Adjustable
			(ft-lbs) +25% -0%		(psi)	(psi)	(ft-lbs) +25% -0%		(psi)	(psi)
02	1/8	5/16-24	6		4500	4500	-	-	-	
03	3/16	3/8-24	7		4500	4500	7	5800	9100	
04	1/4	7/16-20	13		4500	4500	15	5800	9100	
05	5/16	1/2-20	18		4500	4500	18	5800	9100	
06	3/8	9/16-18	22		3600	4500	26	5800	9100	
08	1/2	3/4-16	37		3600	4500	52	5800	9100	
10	5/8	7/8-14	44		2900	3600	74	5800	9100	
12	3/4	1-1/16-12	70		2900	3600	125	5800	5800	
14	7/8	1-3/16-12	92		2300	2900	158	5800	5800	
16	1	1-5/16-12	111		2300	2900	199	4500	5800	
20	1 1/4	1-5/8-12	147		1800	2300	210	3600	3600	
24	1 1/2	1-7/8-12	155		1800	2300	273	2900	3600	
32	2	2-1/2-12	221		1450	1800	-	-	-	

* = Light duty studs included on JIC, NPTF and NPSM fittings per SAE J1926/3 & J514
 ** = Heavy duty studs included on ORFS fittings per SAE J1926/2 & J1453

Note: Torque values are for wet torque and are allowed up to 25% the listed value according to SAE J2593.

Table 2: SAE O-Ring Boss Specifications

Pipe & Pipe Swivel Adapter Specifications

NPSM fittings include an inverted 60° cone inside an internally threaded swivel union nut. Male NPTF fittings that have a 30° internal chamfer that make a 60° inverted cone, will mate with NPSM swivel unions (*Figure 7*).

NOTE: THE MATING MALE THREADS MUST INCLUDE AN INSIDE CHAMFER ON THE END OF THE FITTING THAT MATES WITH THE INVERTED CONE. THREADS ARE FOR CLAMPING FORCE ONLY AND THE SEALING OCCURS ON A SMALL RADIAL SECTION BETWEEN THE MALE FITTING INTERNAL CHAMFER AND THE SWIVEL UNION INVERTED CONE.

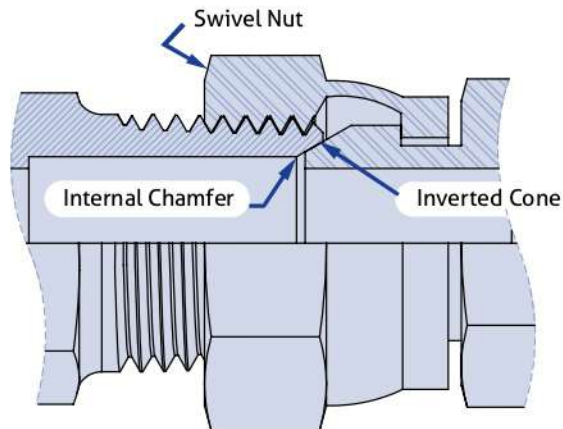

Figure 7 : NPTF & NPSM Union

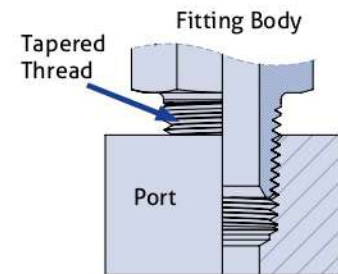

Figure 8: NPT & NPTF Assembly

NPT and NPTF (*Figure 8*) pipe threads seal by wedging the tapered threads through deformation into each other. Both of these threads require thread sealants to complete a seal.

The following table lists the specifications for NPT, NPTF, and NPSM Pipe adapters.

NPT, NPTF, and NPSM Pipe Specifications						
Dash Size	Thread Size	Major OD* (inch)	Working Pressure		Torque	
			NPT, NPTF Male and Female	NPSM Female Swivel Nut	NPT, NPTF	NPSM Swivel Union
			(psi)	(psi)	(TFFT)	(FFWR)
02	1/8-27	.405	5000	5000	2-3	2
04	1/4-18	.540	4000	5000	2-3	2
06	3/8-18	.675	3000	4000	2-3	2
08	1/2-14	.84	3000	3500	2-3	2
12	3/4-14	1.050	2500	2250	2-3	2
16	1-11 1/2	1.315	2000	2000	1 1/2 - 2 1/2	1 1/2
20	1 1/4-11 1/2	1.660	1150	1625	1 1/2 - 2 1/2	1 1/2
24	1 1/2-11 1/2	1.900	1000	1250	1 1/2 - 2 1/2	1 1/2
32	2-11 1/2	2.375	1000	1125	1 1/2 - 2 1/2	1 1/2

Values are per SAE J514 & J2593

Table 3: NPT, NPTF, and NPSM Pipe Specifications

O-ring Face Seal Adapter Specifications

O-ring face seal fittings include a precision groove in the face of the male fitting. Sealing occurs when an O-ring is trapped in the groove by a smooth flat flange that is clamped against the face with a nut or nut and sleeve. The flat flange may be formed or brazed onto the end of a tube, or is machined on a fitting. (Figure 9)

There are two SAE groove types:

- Type A: The original style A O-ring has no retaining ledge. (Figure 10)
- Type B: The Type B groove has a retaining ledge (half dovetail) that improves O-ring retention. The Type B style is more commonly found and is a design improvement over the Type A. (Figure 11)

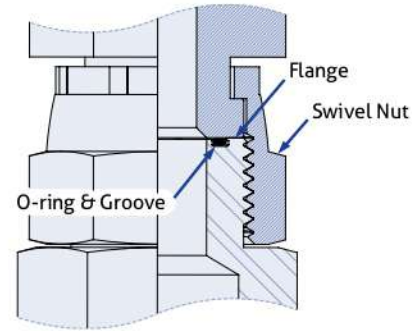

Figure 9 : ORFS Fitting Assembly

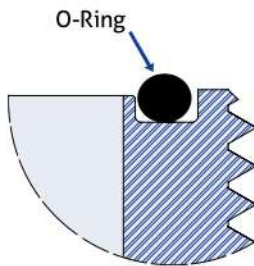

Figure 10: Detail View of Cross Section of Groove Type A

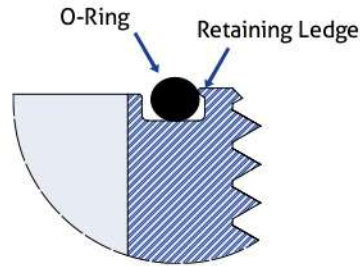

Figure 11 : View of Groove Type B

The following table lists the specifications for O-ring Face Seal adapters.

ORFS Specifications								
Dash Size	Tube Size	Thread Size	Working Pressure		Torque			
			Male	Female Swivel Nut	Male & Female	Bulkhead Locknut	Tube Nuts	Swivel Nuts
			(psi)	(psi)	(ft-lbs) +25% -0%	(ft-lbs) +25% -0%	FFWR	FFWR
04	1/4	9/16-18	6000	6000	18	16	1/4-1/2	1/2-3/4
06	3/8	11/16-16	6000	6000	29	22	1/4-1/2	1/2-3/4
08	1/2	13/16-16	6000	6000	41	29	1/4-1/2	1/2-3/4
10	5/8	1-14	6000	6000	44	44	1/4-1/2	1/2-3/4
12	3/4	1-3/16-12	6000	6000	66	66	1/4-1/2	1/3-1/2
16	1	1-7/16-12	6000	5000	92	92	1/4-1/2	1/3-1/2
20	1 1/4	1-11/16-12	4000	4000	125	111	1/4-1/2	1/3-1/2
24	1 1/2	2-12	4000	3000	147	125	1/4-1/2	1/3-1/2

Note: Values are per SAE J2593 & J1453

Torque values are for wet installation of steel components. Reduce torque values for softer material components.

Table 4: ORFS Specifications

Code 61 & 62 Flange Specifications

Flange ports have a smooth machined surface with four threaded holes around the port. The threads provide a clamping force for the flange against the port. An O-ring seal is trapped in the flange fitting around the port. *(Figure 12)*

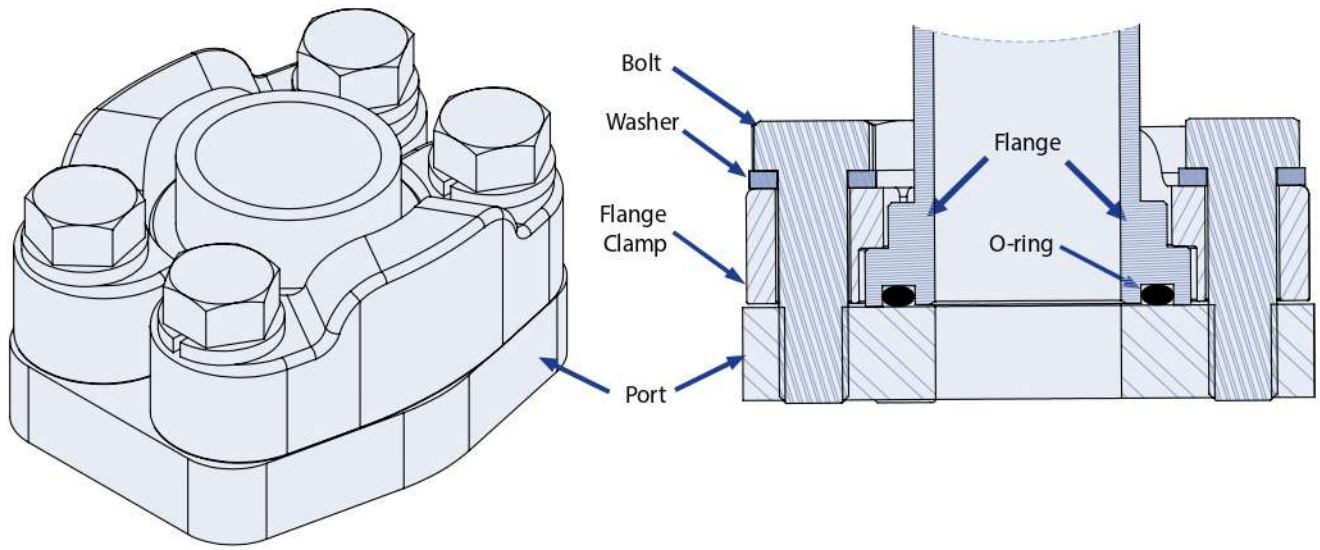

Figure 12 : Flange Port Assembly (Left) Cross Section Flange Port Assembly (Right)

The flange may be a single piece or an assembly (single piece flange is not shown). A single flange piece has four holes that mate with the clamping holes. The assembly flange is a cylindrical shape and is clamped with a full circle flange clamp containing four bolt holes, or with two split flange clamps containing two bolt holes each. *(Figure 12)*

There are two pressure-rated standards:

- Code 61 (Standard Pressure)
- Code 62 (High Pressure)

Each style and size has a unique bolt pattern. The high pressure Code 62 assembly flanges have a larger diameter and thickness than the standard pressure Code 61 flanges.

Code 61 (Standard Pressure) Flanges

The following table lists the specifications for Code 61 flanges.

Flange Code 61 Specifications				
Dash Size	Tube Size	Working Pressure	Torque*	Torque**
		(psi)	+10%- 0% (ft-lbs)	+10%- 0% (ft-lbs)
08	1/2	5000	18	24
12	3/4	5000	32	44
16	1	5000	32	44
20	1 1/4	4000	52	68
24	1 1/2	3000	77	111
32	2	3000	77	111
40	2 1/2	2500	77	111
48	3	2000	155	217
56	3 1/2	500	155	217
64	4	500	155	217

Torque values are per SAE J2593 and for wet installation of steel components. Reduce torque values for softer material components.

* Torque for SAE Grade 5 Screws
 ** Torque for SAE Grade 8 Screws

Table 5: Flange Code 61 Specifications

The following table lists the dimensions for Code 61 flanges.

Flange Code 61 Dimensions								
Dash Size	Tube Size	C	E	Q	GG	A	Z INCH Threads	Z METRIC Threads
08	1/2	1.188	0.265	1.5	0.688	0.50	5/16-18	M8 x 1.25
12	3/4	1.500	0.265	1.875	0.875	0.75	3/8-16	M10 x 1.5
16	1	1.750	0.315	2.082	1.031	1.00	3/8-16	M10 x 1.5
20	1 1/4	2.000	0.315	2.312	1.188	1.25	7/16-14	M10 x 1.5
24	1 1/2	2.375	0.315	2.750	1.406	1.50	1/2-13	M12 x 1.75
32	2	2.812	0.375	3.062	1.688	2.00	1/2-13	M12 x 1.75
40	2 1/2	3.312	0.375	3.500	2.000	2.50	1/2-13	M12 x 1.75
48	3	4.000	0.375	4.188	2.438	3.00	5/8-11	M16 x 2
56	3 1/2	4.500	0.422	4.750	2.750	3.50	5/8-11	M16 x 2
64	4	5.000	0.442	5.125	3.062	4.00	5/8-11	M16 x 2

Hex head bolts are grade 5 and socket head cap bolts are grade 8.

Table 6: Flange Code 61 Dimensions

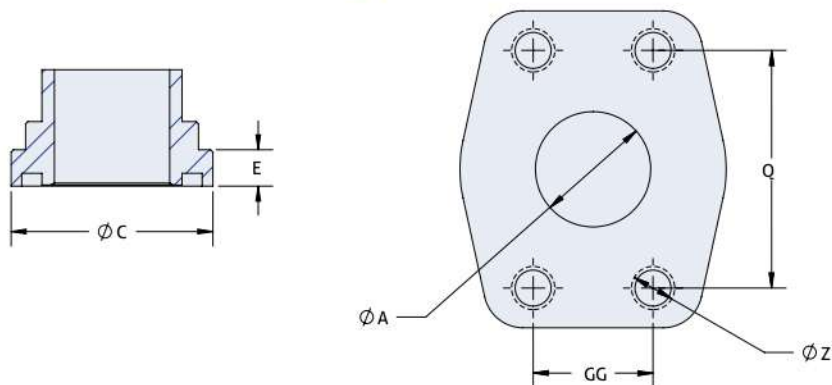

Figure 13 : Code 61 and 62 Figures of the flange (Left) and bolt pattern (Right)

Code 62 (High Pressure) Flanges

The following table lists the specifications for Code 62 flanges.

Flange Code 62 Specifications					
Dash Size	Tube Size	Working Pressure	Torque Range ^{**}	Average Torque ^{**}	Torque ^{**}
		(psi)	(in-lbs)	(ft-lbs)	+10%-0% (ft-lbs)
08	1/2	6000	175-225	17	24
12	3/4	6000	300-400	29	44
16	1	6000	500-600	46	68
20	1 1/4	6000	750-900	69	111
24	1 1/2	6000	1400-1600	125	217
32	2	6000	2400-2600	208	332

Standards per SAE J2593 & J518

*Torque for SAE Grade 5 Screws
 **Torque for SAE Grade 8 Screws

Table 7: Flange Code 62 Specifications

The following table lists the dimensions for Code 62 flanges.

Flange Code 62 Dimensions								
Dash Size	Tube Size	C	E	Q	GG	A	Z INCH Threads	Z METRIC Threads
08	1/2	1.250	0.305	1.594	0.718	0.50	5/16-18	M8 x 1.25
12	3/4	1.625	0.345	2.00	0.937	0.75	3/8-16	M10 x 1.5
16	1	1.875	0.375	2.250	1.093	1.00	7/16-14	M12 x 1.75
20	1 1/4	2.125	0.405	2.625	1.250	1.25	1/2-13	M14 x 2.0
24	1 1/2	2.500	0.495	3.125	1.437	1.50	5/8-11	M16 x 2.0
32	2	3.125	0.495	3.812	1.750	2.00	3/4-10	M20 x 2.5

Note: Hex head bolts are grade 5 and socket head cap bolts are grade 8.

Table 8: Flange Code 62 Dimensions

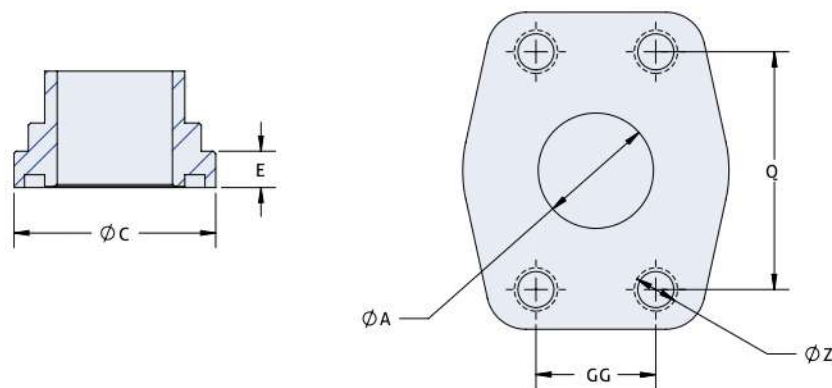

Figure 13 : Code 61 and 62 Figures of the flange (Left) and bolt pattern (Right)

BSPT, BSPP (DIN 3852-2) and Metric (DIN 3852-1) Adapter Specifications

BSPT and Metric tapered threads install and work in the same manner as NPT and NPTF.

Male BSPP fittings include an inverted 60° cone inside an internally threaded swivel union nut. (Figure 15) Male BSPP fittings that have a 30° internal chamfer that make a 60° inverted cone, will mate with Female BSPP swivel unions.

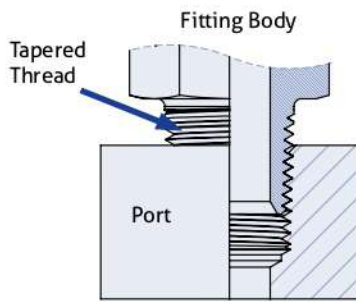

Figure 14: BSPT Assembly

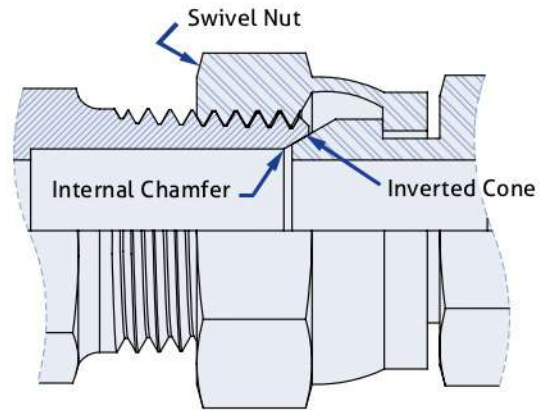

Figure 15: BSPP Union

NOTE: THE MATING MALE THREADS MUST INCLUDE AN INSIDE CHAMFER ON THE END OF THE FITTING THAT MATES WITH THE INVERTED CONE. THREADS ARE FOR CLAMPING FORCE ONLY AND THE SEALING OCCURS ON A SMALL RADIAL SECTION BETWEEN THE MALE FITTING INTERNAL CHAMFER AND THE SWIVEL UNION INVERTED CONE.

DIN swivel unions (Figure 16) have a 24° inverted cone and may be installed into DIN bite-ring compression fittings. To provide enhanced performance, an O-ring is sometimes included in the cone of some DIN swivel unions. (Figure 16 Detail A)

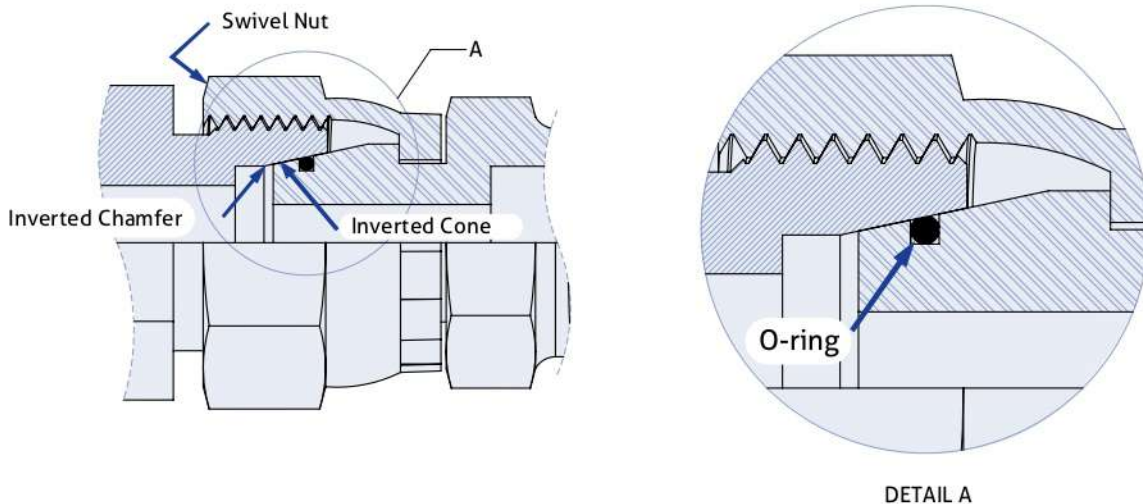

Figure 16: DIN Swivel Union

British Standard Pipe Parallel (BSPP, DIN 3852-2, ISO 1179-1) and Metric Parallel (DIN 3852-1, ISO 9974-1) threaded ports do not include a port cavity like the O-ring Boss or ISO 6149 port. Instead, an O-ring sits on top of the spot face or external surface and is surrounded by a metal retaining ring or other retaining component to trap the O-ring between the fitting hex, body, and spot face. (Figure 17)

Elbow and Tee fittings have a locknut, backup washer, O-ring and retaining washer to permit 360° orientation around the axis of the port. (Figure 18)

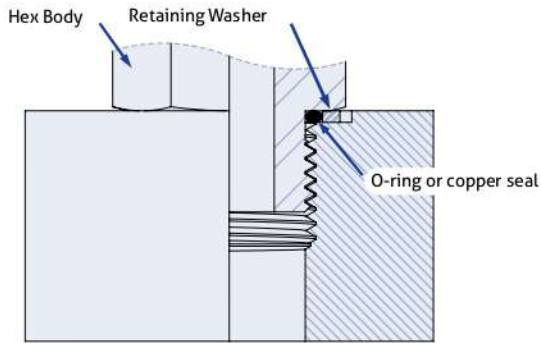

Figure 17: BSPP & Metric Straight (DIN 3852-1 & -2)

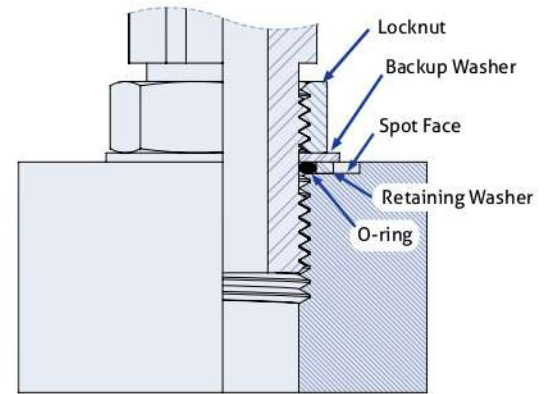

Figure 18: BSPP & Metric Adjustable (DIN 3852-1 & -2)

There are three sealing designs for either the BSPP or Metric parallel thread:

1. A retaining ring and O-ring. Some straight fittings may have a seal that is bonded into the inside edge of a washer. This is known as a bonded seal or a Dowty seal (not shown). For extreme heat applications, straight fittings may include a copper washer for a seal. (Figure 19)
2. Cutting face metal seal between the fitting and the spot face. (Figure 20)
3. Elastomeric (ED) seal or P-Flex seal. A precision groove is machined on the bottom of the fittings hex with a seal installed in this groove. For the parallel fittings, the threads are for holding power or clamping force only and the seal occurs on the spot face. For tapered BSPT fittings the holding and sealing is done in the threads with the help of a pipe sealant such as PTFE tape or an anaerobic liquid. (Figure 21)

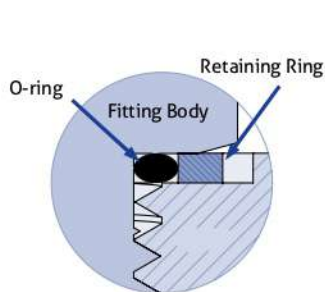

Figure 19:
Retaining Ring with O-ring Seal

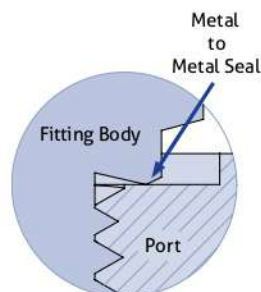

Figure 20:
Cutting Face Seal

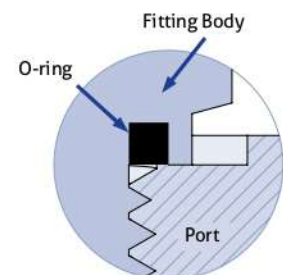

Figure 21:
Elastomeric Seal

Appendix: Technical Information

The following table lists the specifications for BSPP & BSPT adapters.

BSPP & BSPT Specifications				
Dash Size	BSPT & BSPP		Torque	
	THREAD SIZE	MAJOR OD*	BSPP Swivel Union	BSPT
		<i>(inch)</i>	<i>(FFWR)</i>	<i>(TFFT)</i>
02	1/8-28	0.383	2	2-3
04	1/4-19	0.518	2	2-3
06	3/8-19	0.656	2	2-3
08	1/2-14	0.825	2	2-3
10	5/8-14	0.929	2	2-3
12	3/4-14	1.041	2	2-3
16	1-11	1.309	1 1/2	1 1/2 - 2 1/2
20	1 1/4-11	1.650	1 1/2	1 1/2 - 2 1/2
24	1 1/2-11	1.882	1 1/2	1 1/2 - 2 1/2
32	2-11	2.347	1 1/2	1 1/2 - 2 1/2

*Reference ISO-228-1, Table 1

Table 9: BSPP & BSPT Specifications

The following table lists the specifications for Metric adapters.

Metric DIN 3852-1 Threads	
Dash Size	THREAD SIZE
	<i>(mm)</i>
08	8 x 1.0
10	10 x 1.0
12	12 x 1.5
14	14 x 1.5
16	16 x 1.5
18	18 x 1.5
20	20 x 1.5
22	22 x 1.5
24	24 x 1.5
26	26 x 1.5
27	27 x 2.0
30	30 x 2.0
33	33 x 2.0
39	39 x 2.0
42	42 x 2.0
48	48 x 2.0
60	60 x 2.0

Values are from DIN 3852-1 & ISO 9974-1

Table 10: Metric DIN 3852-1 Threads

Metric Compression Tube (DIN LL, L, & S) Adapter Specifications

You can use a metric compression tube adapter with different types of fitting connections that use a metric tube size. The DIN figure to the right shows the cross sectional cut of a DIN connection. The Tube Pilot dimension is P. The thread size is the Thread O.D.

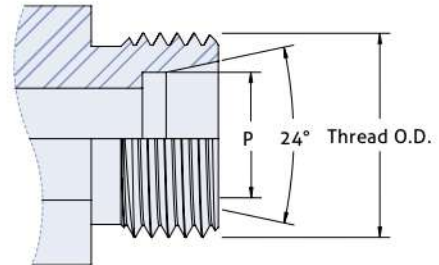

Figure 22: DIN Identification

The following table lists the specifications for DIN LL adapters.

DIN LL			
Metric Tube O.D. Size	Thread O.D.	Tube (P)ilot	Pressure
(mm)	(mm)	(mm)	(psi)
4	8 x 1.0	4	1500
6	10 x 1.0	6	1500
8	12 x 1.0	8	1500
10	14 x 1.0	10	1500
12	16 x 1.0	12	1500

*Meets standard ISO 8434-1

Table 11: DIN LL

The following table lists the specifications for DIN L adapters.

DIN S			
Metric Tube O.D. Size	Thread O.D.	Tube (P)ilot	Pressure
(mm)	(mm)	(mm)	(psi)
6	14 x 1.5	6	9000
8	16 x 1.5	8	9000
10	18 x 1.5	10	9000
12	20 x 1.5	12	9000
14	22 x 1.5	14	5800
16	24 x 1.5	16	5800
20	30 x 2.0	20	5800
25	36 x 2.0	25	5800
30	42 x 2.0	30	3600
38	52 x 2.0	38	3600

*Meets standard ISO 8434-1

Table 13: DIN S

The following table lists the specifications for DIN S adapters.

DIN L			
Metric Tube O.D. Size	Thread O.D.	Tube (P)ilot	Pressure
(mm)	(mm)	(mm)	(psi)
6	12 x 1.5	6	3600
8	14 x 1.5	8	3600
10	16 x 1.5	10	3600
12	18 x 1.5	12	3600
15	22 x 1.5	15	3600
18	26 x 1.5	18	2300
22	30 x 2.0	22	2300
28	36 x 2.0	28	1500
35	45 x 2.0	35	1500
42	52 x 2.0	42	1500

*Meets standard ISO 8434-1

Table 12: DIN L

Metric ISO 6149 Adapter Specifications

These types of fittings are similar in design to the SAE O-ring Boss fittings but with a metric thread.

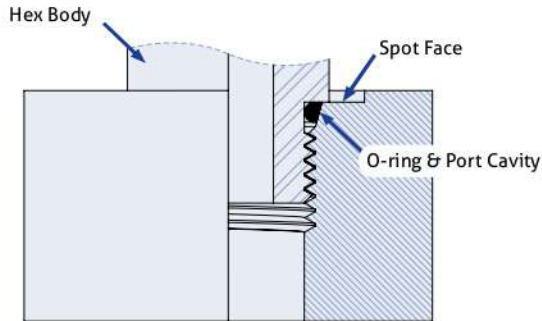

Figure 23: Straight ISO 6149

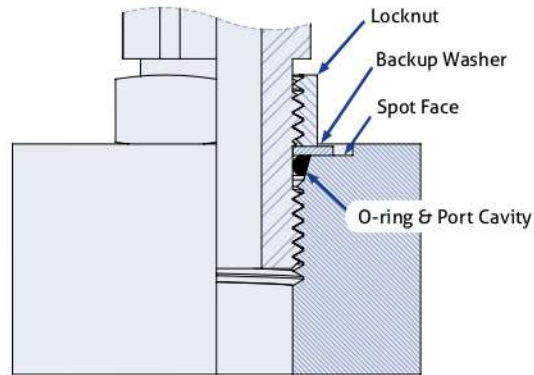

Figure 24: Adjustable ISO 6149

NOTE: THE RATINGS OF THE ISO 6149 FITTING ARE DIFFERENT THAN ITS COUNTERPART SAE O-RING BOSS.

The following table lists the specifications for Metric ISO 6149 adapters.

Metric ISO 6149 Specifications								
Dash Size	Tube Size	Thread	Light Duty			Heavy Duty		
			Torque	Working Pressure		Torque	Working Pressure	
			Adjustable & Non-Adjustable	Adjustable	Non-Adjustable	Adjustable & Non-Adjustable	Adjustable	Non-Adjustable
			(ft-lbs) +25% -0%	(psi)	(psi)	(ft-lbs) +25% -0%	(psi)	(psi)
08	4	8 x 1.0	6	4500	5800	7	-	-
10	5	10 x 1.0	11	4500	5800	15	5800	9100
12	6	12 x 1.5	18	4500	5800	26	5800	9100
14	8	14 x 1.5	26	4500	5800	33	5800	9100
16	10	16 x 1.5	30	3600	4500	40	5800	9100
18	12	18 x 1.5	33	3600	4500	52	5800	9100
22	16	22 x 1.5	44	3600	4500	74	5800	9100
27	20	27 x 2.0	75	2300	2900	125	5800	5800
30	22	30 x 2.0	95	2300	2900	158	5800	5800
33	25	33 x 2.0	120	2300	2900	228	5800	5800
42	30	42 x 2.0	155	2300	2900	243	4500	3600
48	38	48 x 2.0	190	2300	2900	310	2900	3600
60	50	60 X 2.0	230	1450	2300	369	2300	3600

* = Light Duty per SAE J2244/3
 ** = Heavy Duty per SAE J2244/2

Torque values are for wet torque only and are allowed up to 25% the listed value according to SAE J2593 recommendations. Reduce torque values for softer material components.

Table 14: Metric ISO 6149 Specifications

Compression & Flared Adapter Thread Sizes

The following table lists the compression and flared fitting thread sizes.

Compression & Flared Fitting Thread Sizes					
Dash Size	Tube Size	Steel Compression *	Brass SAE 45° Flare **	Brass Inverted Flare **	Brass SAE Compression **
02	1/8	5/16-24	5/16-24	5/16-28	5/16-24
03	3/16	3/8-24	3/8-24	3/8-24	3/8-24
04	1/4	7/16-20	7/16-20	7/16-24	7/16-24
05	5/16	1/2-20	1/2-20	1/2-20	1/2-24
06	3/8	9/16-18	5/8-18	5/8-18	9/16-24
08	1/2	3/4-16	3/4-16	3/4-18	11/16-20
10	5/8	7/8-14	7/8-14	7/8-18	13/16-18
12	3/4	1 1/16-12	1-1/16-14	1-1/16-16	1-18
14	7/8	1 3/16-12	1-1/4-12	-	-
16	1	1 5/16-12	1-3/8-12	-	-
20	1 1/4	1 5/8-12	-	-	-
24	1 1/2	1 7/8-12	-	-	-
32	2	2 1/2-12	-	-	-

* Values are per SAE J514 standard thread sizes.
 ** Values are per SAE J512 standard thread sizes

Table 15: Compression & Flared Fitting Thread Sizes

JIS & Komatsu® Adapter Thread Sizes

The following tables list the JIS and Komatsu® specifications.

JIS Specifications	
Dash Size	THREAD SIZE
02	1/8-28
04	1/4-19
06	3/8-19
08	1/2-14
10	5/8-14
12	3/4-14
16	1-11
20	1 1/4-11
24	1 1/2-11
32	2-11

Table 16: JIS Specifications

Komatsu®	
Dash Size	THREAD SIZE
14	14 x 1.5
18	18 x 1.5
22	22 x 1.5
24	24 x 1.5
30	30 x 1.5
33	33 x 1.5

Table 17: Komatsu®

Quick Disconnect Identification Chart

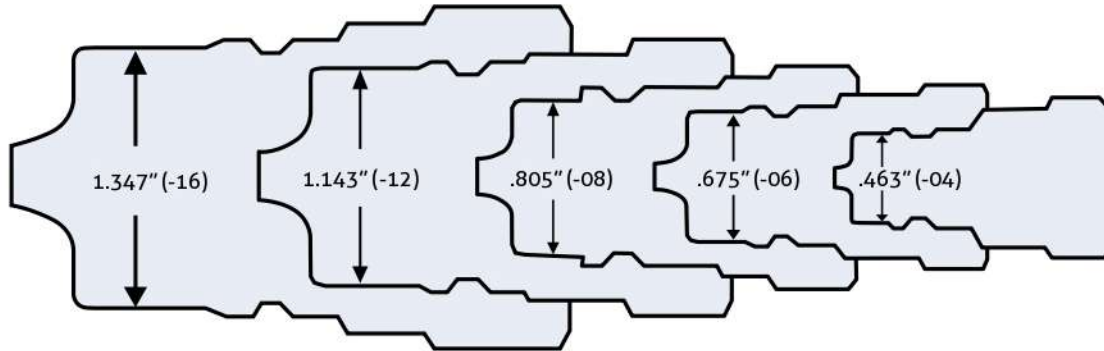

Figure 25: ANV Profile

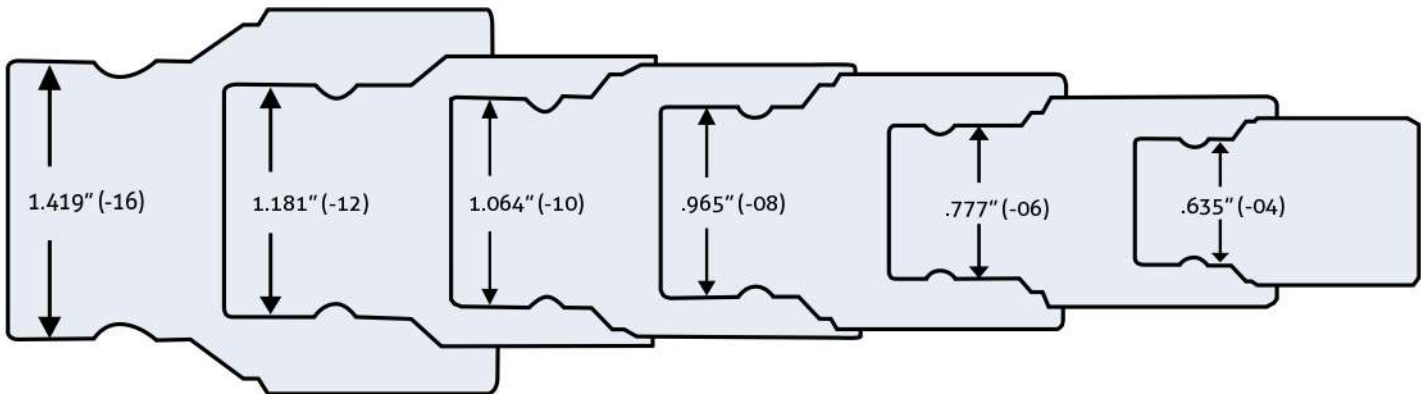

Figure 26: FFI Profile

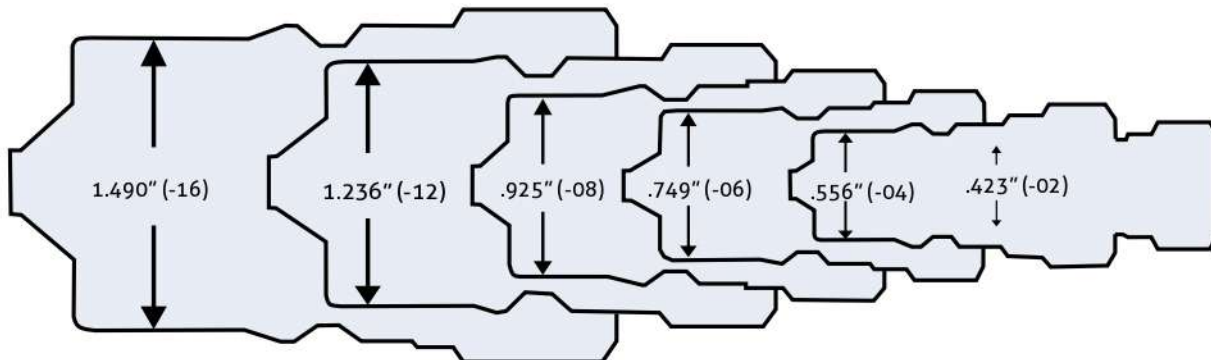

Figure 27: HNV Profile

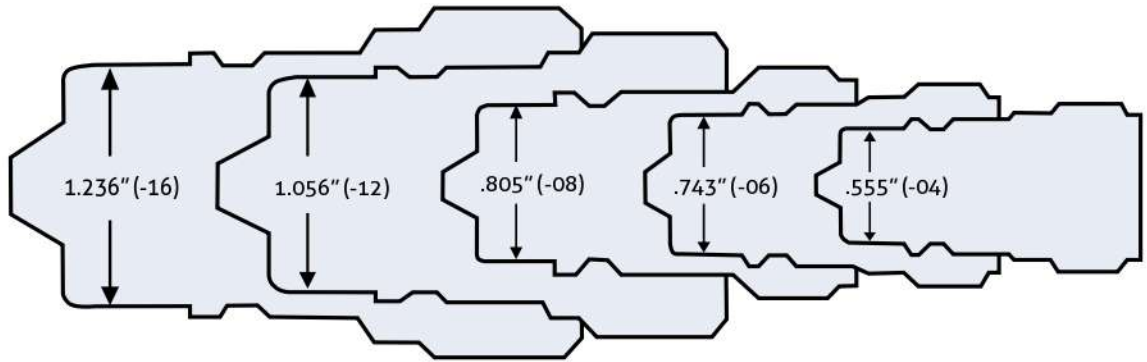

Figure 28: NV Profile

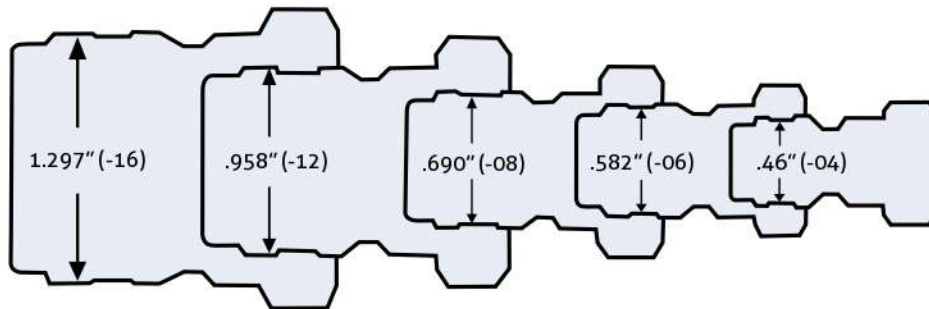

Figure 29: ST Profile

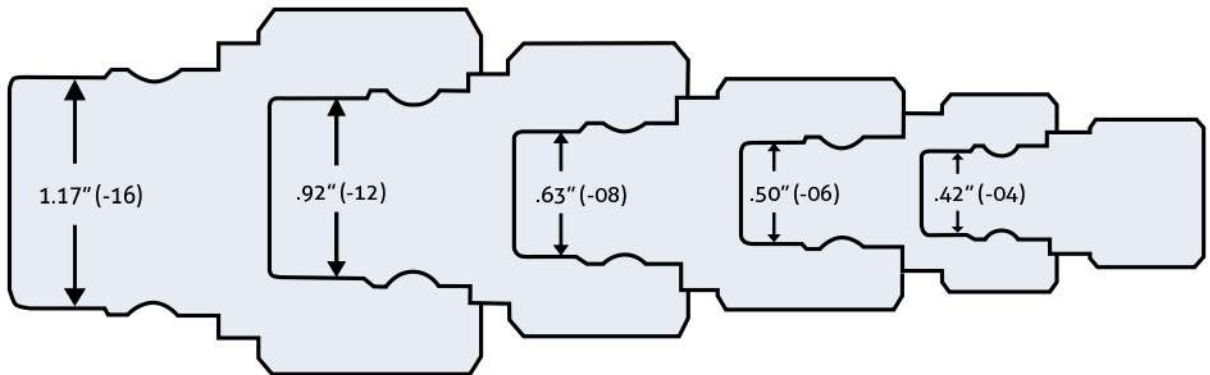

Figure 30: TNV Profile

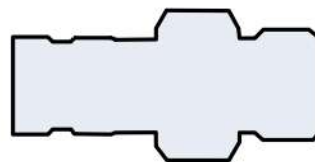

Figure 31: PD Profile

TABLES

Table 1: JIC Specifications	305
Table 2: SAE O-Ring Boss Specifications	306
Table 3: NPT, NPTF, and NPSM Pipe Specifications	307
Table 4: ORFS Specifications	308
Table 5: Flange Code 61 Specifications	310
Table 6: Flange Code 61 Dimensions	310
Table 7: Flange Code 62 Specifications	311
Table 8: Flange Code 62 Dimensions	311
Table 9: BSPP & BSPT Specifications	314
Table 10: Metric DIN 3852-1 Threads	314
Table 11: DIN LL	315
Table 12: DIN L	315
Table 13: DIN S	315
Table 14: Metric ISO 6149 Specifications	316
Table 15: Compression & Flared Fitting Thread Sizes	317
Table 16: JIS Specifications	317
Table 17: Komatsu®	317

FIGURES

Figure 1: FFWR Diagram	303
Figure 2: NPTF Thread View	304
Figure 3: NPT Thread View	304
Figure 4: Flare Fitting Assembly	305
Figure 5: Straight SAE ORB	306
Figure 6: Adjustable SAE ORB	306
Figure 7: NPTF & NPSM Union	307
Figure 8: NPT & NPTF Assembly	307
Figure 9: ORFS Fitting Assembly	308
Figure 10: Detail View of Cross Section of Groove Type A	308
Figure 11: View of Groove Type B	308
Figure 12: Flange Port Assembly (Left) Cross Section Flange Port Assembly (Right)	309
Figure 13: Code 61 and 62 Figures of the flange (Left) and bolt pattern (Right)	310
Figure 13: Code 61 and 62 Figures of the flange (Left) and bolt pattern (Right)	311
Figure 14: BSPT Assembly	312
Figure 15: BSPP Union	312
Figure 16: DIN Swivel Union	312
Figure 17: BSPP & Metric Straight (DIN 3852-1 & -2)	313
Figure 18: BSPP & Metric Adjustable (DIN 3852-1 & -2)	313
Figure 19: Retaining Ring with O-ring Seal	313
Figure 20: Cutting Face Seal	313
Figure 21: Elastomeric Seal	313
Figure 22: DIN Identification	315
Figure 23: Straight ISO 6149	316
Figure 24: Adjustable ISO 6149	316
Figure 25: ANV Profile	318
Figure 26: FFI Profile	318
Figure 27: HNV Profile	318
Figure 28: NV Profile	319
Figure 29: ST Profile	319
Figure 30: TNV Profile	319
Figure 31: PD Profile	319

INDEX

29T	205	90DB	47	303	23	1501-LL	68
40C	198	90DF	106	304	23	1502	68
40P	198	90DF	110	304-C	23	1503	69
41	198	90DFF	90	306	24	1504	69
41S	199	100	220	318	24	1562	240
42	199	105	220	319	24	1564	240
44	199	131	220	352	222	1565	240
45	200	202	221	402	222	1566	240
46	200	252	221	403	25	1568	241
48	201	260P	227	404	48	1569	241
49	201	260PB	227	418	25	1570	241
50	202	261P	227	419	26	1571	242
51	202	261PB	227	452	222	1572	242
52	203	261U	228	500	26	1577	242
54	203	262P	228	502	222	1579	242
55	204	262PP	231	602	223	1582	243
60	214	263PP	231	702	223	1601	70
60P	214	264P	228	752	223	1602	70
61	214	264PP	231	1404	66	1603	70
61C	215	265PP	231	1405	66	1604	71
61L	215	266P	228	1406	67	2403	4
62	215	266PP	232	1460	235	2403-LH	5
62-BH	215	268P	229	1461	235	2404	5
64	216	268PP	232	1462	235	2404-L	6
65	216	269P	229	1464	235	2404-LL	7
66	216	269PP	232	1465	236	2404-LLL	7
67	217	270P	229	1466	236	2405	7
68	217	270PP	233	1468	236	2406	8
69	218	271P	230	1469	237	2407	10
70	218	271PP	233	1470	237	2408	10
71	219	272P	230	1471	237	2500	11
72	219	272PP	233	1472	238	2501	11
73	219	279PP	234	1473	238	2501-L	12
75DB-Viton	47	282P	230	1474	238	2501-LL	13
75DFF-Viton	90	282PP	234	1480	238	2501-LLL	13
75DF-Viton	105	284PP	234	1484	239	2501-S	14
75DF-Viton	109	302	221	1501	67	2502	14

2503	15	3404	140	3823	129	4200	205
2504	15	3405	115	3825	130	4244	205
2505	16	3406	115	3826	131	4245	206
2601	16	3408	116	3827	144	4245-S	207
2602	17	3408-HHP	116	3828	131	4250	207
2603	17	3420	116	3832	132	4255	207
2605	18	3421	117	3835	132	4290	208
2606	18	3422	118	3840	132	4295	208
2607	19	3425	118	3853	133	4300	210
2611	19	3426	118	3854	134	4301	210
2650	19	3430	119	3855	134	4303	210
2700	20	3435	119	3856	134	4305	211
2701	20	3436	120	3857	135	4311	211
2702	20	3437	120	3858	135	4312	211
2703	21	3455	121	3859	135	4313	212
2704	21	3500	196	3860	135	4315	212
2705	22	3501	140	3861	152	4320	212
2706	22	3503	141	3862	153	4330	212
2708	48	3506	141	3863	153	4390	213
3120	190	3508	142	3864	153	4404	91
3129	190	3508-HHP	142	3866	153	4444	91
3149	190	3520	142	3871	154	4445	92
3150	190	3524	143	3900	196	4501	92
3151	191	3540	122	3901	136	4503	93
3152	191	3544	122	3903	136	4601	93
3200	191	3545	143	3904	136	4603	94
3220	192	3600	196	3905	136	4604	94
3223	152	3601	123	3950	197	5000	48
3224	152	3602	123	4024	244	5400-CL	49
3225	152	3620	124	4025	244	5400-N	49
3240	114	3656	143	4026	244	5404	51
3250	192	3657	144	4030	244	5404-L	51
3300	193	3701	124	4040	244	5405	52
3300-BH	193	3702	125	4044	245	5406	53
3325	193	3750	196	4045	245	5406-CAP	54
3326	194	3800	125	4050	245	5406-E	54
3327	194	3800-L	126	4100	245	5406-FLP	54
3350	195	3801	126	4100-L	245	5406-HHP	55
3390	195	3802	127	4144	246	5406-P	55
3400	195	3807	127	4144-L	246	5406-SHP	55
3401	114	3810	127	4145	246	5500	56
3402	114	3820	128	4145-L	246	5500-S	56

5501	56	6603	33	7420	147	FF2404	75
5502	57	6606	34	7430	148	FF2405	75
5502-S	57	6701	34	7455	148	FF2406	76
5502-X	57	6701-L	34	7625	149	FF2407	76
5503	58	6701-LXH	35	7801	149	FF2408	77
5504	58	6701-XH	34	7802	150	FF2500	77
5505	58	6702	35	7861	154	FF2501	77
5600	59	6801	35	7862	154	FF2503	78
5601	59	6801-L	36	7865	154	FF2601	78
5602	59	6801-LL	37	7868	155	FF2603	78
5603	60	6801-LLL	37	7869	155	FF2605	79
5604	60	6801-S	37	ANV-DC	261	FF2650	79
5605	60	6802	38	ANV-DP	261	FF2700	79
5650	61	6803	39	ANV-F	260	FF2701	79
5652	61	6804	40	ANV-M	260	FF2702	80
5655	61	6805	64	BFL	209	FF2703	80
5700	204	6805-L	64	BV	197	FF2704	80
5790	204	6806	65	CP	106	FF2705	81
6400	26	6807	45	CPX	110	FF2706	81
6400-L	28	6809	40	DC602	224	FF3019	81
6401	61	6815	46	DC603	224	FF3800	137
6402	28	6832	46	DC604	224	FF3801	138
6403	42	6835	46	DC606	224	FF3802	138
6403-NWO	42	6840	96	DC607	224	FF3859	138
6404	62	6842	96	DS-BSP	137	FF3860	139
6405	63	6845	97	DS-MM	150	FF6400	83
6408	43	6847	97	FB-DC	272	FF6400-L	84
6408-HHP	43	6855	65	FB-DP	272	FF6402	84
6410	44	6861	105	FB-F-HN	271	FF6500	85
6410-L	45	6861-P	105	FB-F-WN	271	FF6502	85
6420	64	6862	109	FB-M	271	FF6504	85
6425	45	6862-P	109	FBV	248	FF6505	86
6500	29	6890	98	FCC-UP-BN	298	FF6507	86
6501	29	6892	98	FCC-YZ-BN	298	FF6510	86
6502	30	6900	71	FCC-YZ-SC	298	FF6600	86
6503	30	6901	72	FF304-C	81	FF6602	87
6504	31	6902	73	FF306	82	FF6801	87
6505	31	6911	73	FF318	82	FF6801-L	88
6506	32	7400	145	FF319	82	FF6801-LL	88
6510	32	7402	145	FF403	83	FF6801-LLL	88
6600	33	7408	146	FF2402	74	FF6802	88
6602	33	7408-HHP	146	FF2403	74	FF6803	89

FF6804	89	LS-2502	182	MC6027	161	NV102	225
FF6809	90	LS-4244	209	MC6050	162	NV103	225
FF6840	99	LS-4312	213	MC6051	162	NV104	225
FF6842	99	LS-5000	183	MC6052	164	NV105	225
FF7400	151	LS-5405	183	MC6053	165	NV106	226
FF7801	151	LS-5500	183	MC6062	165	NV107	226
FFI-F-DC	270	LS-5502	184	MC6063	166	NV108	226
FFI-F-FB	269	LS-5504	184	MC6070	167	NV109	226
FFI-F-FP	269	LS-6400	184	MC6071	167	NV-DC	263
FFI-M-DC	270	LS-6801	185	MC6080	168	NV-DP	263
FFI-M-FB	268	LS-6806	185	MC6081	168	NV-F-FB	263
FFI-M-FP	268	LS-6815	185	MC6090	169	NV-F-FP	262
FGFF6845	99	LS-6901	186	MC6091	169	NV-M-FB	262
FGFF6847	100	LS-FF2403	186	MC6100	170	NV-M-FP	262
FGFF6890	100	LS-FF2406	186	MC6101	170	PD-DC	274
FGFF6892	100	LS-FF6400	186	MC6102	171	PD-F-FP	273
FTGK-98	178	LS-FF6801	187	MC6110	171	PD-F-MP	274
GCBP	278	LSS-2501	187	MC6121	173	PD-M-FP	273
GCP	278	LSS-6801	187	MC6122	173	PD-M-MB	273
GHW	246	MBH FFX	279	MC6123	174	PD-M-MP	273
GP6504	278	MBH FJ-FJ	283	MC6132	174	PGL	280
GPFF2406	278	MBH FJX	279	MC6133	175	PT	257
HGCBP	279	MBH FP	279	MC6142	175	PVVM-DC	266
HGCP	279	MBH FP-FP	284	MC6143	176	PVVM-DP	266
HK	296	MBH FP-TP	284	MC6152	176	PVVM-F	266
HNV-DC	265	MBH MP	280	MC6160	177	PVVM-M	266
HNV-DP	265	MBH SP	280	MTGK-98	178	PWHD	256
HNV-F	264	MBH SP90	280	NB6701	41	PWLD	256
HNV-M	264	MBH TP	280	NB6701-L	41	PWP	255
HP	252	MBH TP-TP	284	NB6702	41	SF	106
HP-15PC	252	MBV-FF	248	NB6840	101	SFK KIT	107
HP-50PC	253	MBV-MF	249	NB6842	101	SFX	110
HP-60	253	MC6000	156	NB6845	102	SFXK KIT	110
HPV	250	MC6001	156	NB6847	102	SP	107
LS-1501	180	MC6002	157	NB6890	103	SPX	111
LS-1502	180	MC6003	157	NB6892	103	SS-FBV	249
LS-2403	180	MC6004	158	NBFF6842	104	ST-F-FP	276
LS-2404	181	MC6020	158	NBFF6847	104	ST-F-MP	276
LS-2405	181	MC6021	159	NBFF6890	104	ST-M-FP	275
LS-2406	181	MC6022	160	NBFF6892	104	ST-M-MP	275
LS-2500	182	MC6023	160	NHS	254	SUPRA W2	295
LS-2501	182	MC6026	161	NV101	225	TBC	294

TNV-F	267
TNV-M	267
TPBH	281
TPBP	281
TPBT	281
TPE	281
TPFF-O	281
TPFJ	282
TPJBH	282
TPK-CUSTOM KIT	287
TPK-FF KIT	286
TPK-JIC KIT	285
TPM	282
TPO	282
TPP	283
TPSP	283
TPU-U	283
TPU-V	283
TSL-104	290
TSL-108	290
TSL-211	291
TSL-229	292
TWF	299
TWFN	299
W4	107
W42	111
W43	108
W44	111
W46	108
W48	112
WC42	112
WGC	294

**Hydraulic
Adapters and
Fittings**

**Flanges and
Flange
Adapters**

**Metric Adapters
and Fittings**

Live Swivels

**Brass Adapters
and Fittings**

Ball Valves

**Hose
Protection**

**Quick
Disconnects**

**Test Points
and Test Kits**

Aerosols

Clamps

**Hydraulic Tank
Components**

Tompkins
INDUSTRIES, INC.